



ROYAL RANGERS

1999 CATALOG

BUILDING MEN OF TOMORROW



PIONEERS



TRAIL BLAZERS



CHALLENGERS



BUCKAROO



ROYAL



Dear Commander:

Welcome to the 1999 Royal Rangers catalog.

We realize that being a Royal Rangers leader takes time and energy. Here in the national office, we want your efforts to be spent building young men, not in trying to find products and materials to make your program work.

This year's catalog has been redesigned to help you better find what you need—

- Each program, from Straight Arrows to Challengers, has its own section.
- Camping gear includes several new products and has been expanded to better display and explain the products.
- Pinewood Derby supplies include a new easier-to-make car for younger boys.
- Specially selected products designed to enhance your teaching and ministry have been added to the resources portion of the catalog.
- Several new casual shirts and hats have been added to our clothing section.

We believe the time is right for developing the commanders of tomorrow. Your efforts will be blessed.

In Service to Christ,

Ken Hunt
National Commander
National Royal Rangers Office

WHERE TO FIND IT . . .

| | |
|---------------------------------------|----|
| Program Resources | I |
| Straight Arrows | 3 |
| Buckaroos | 4 |
| Pioneers | 5 |
| Trailblazers | 6 |
| Challengers | 7 |
| Outreach | 10 |
| Uniforms | 11 |
| Uniform Accessories | 13 |
| Awards and Recognition | 15 |
| Flags | 19 |
| Specialty Items and Apparel | 20 |
| Resources | 24 |
| Camping | 27 |
| Pinewood Derby | 30 |



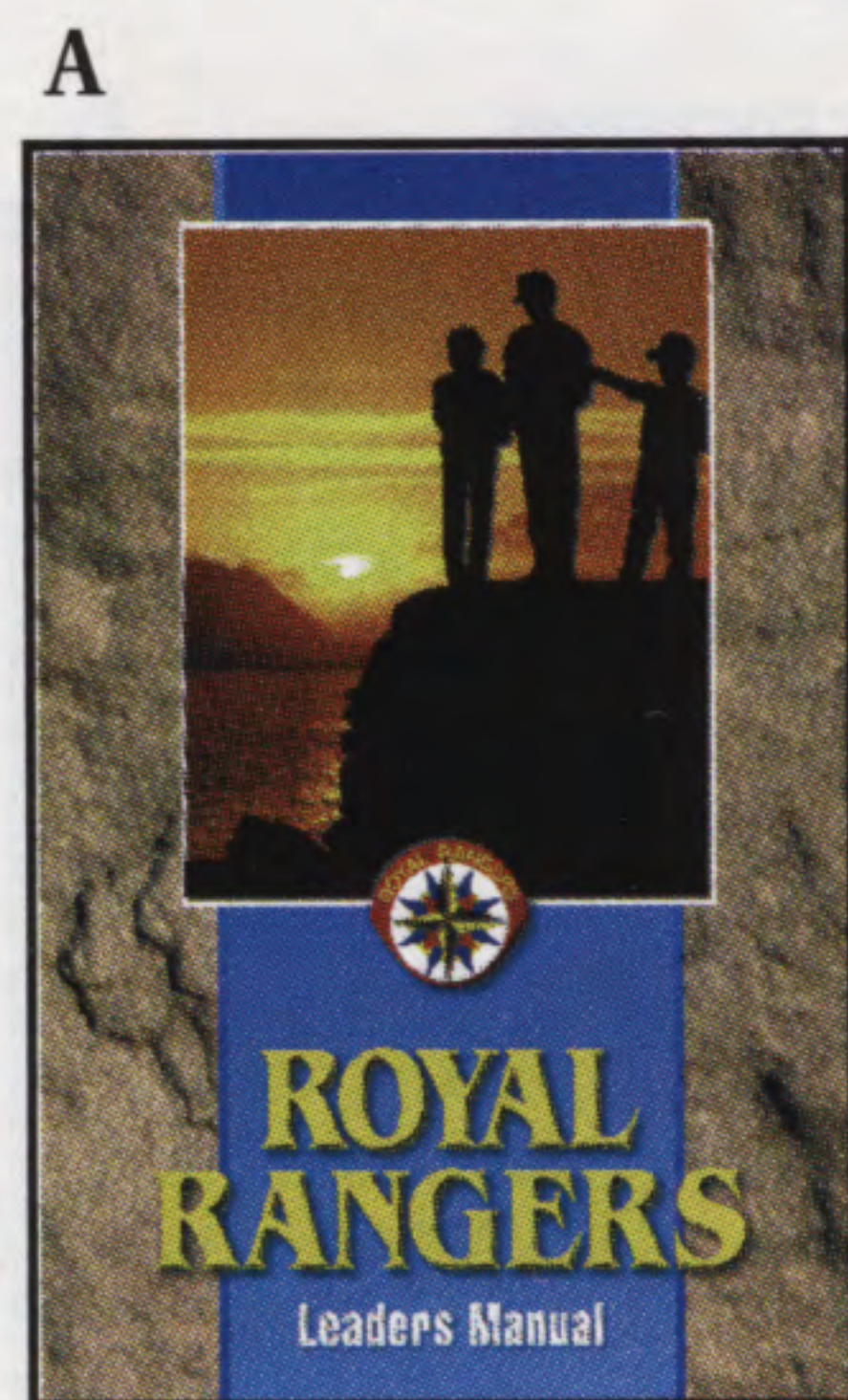

A. The Royal Rangers Leaders Manual, revised. Over 500 pages covering many issues including: Child and substance abuse, AIDS, gifted children, and children with disabilities. Examines: Urban ministries, missions, intercultural ministries, the outreach program, the Royal Ranger of the year program, and many other areas. Includes the guides: Royal Rangers uniforms in full color, Royal Rangers awards and recognition, and *Adventures in Camping*. Required for all commanders. Paper. 02MX1037 \$13.95

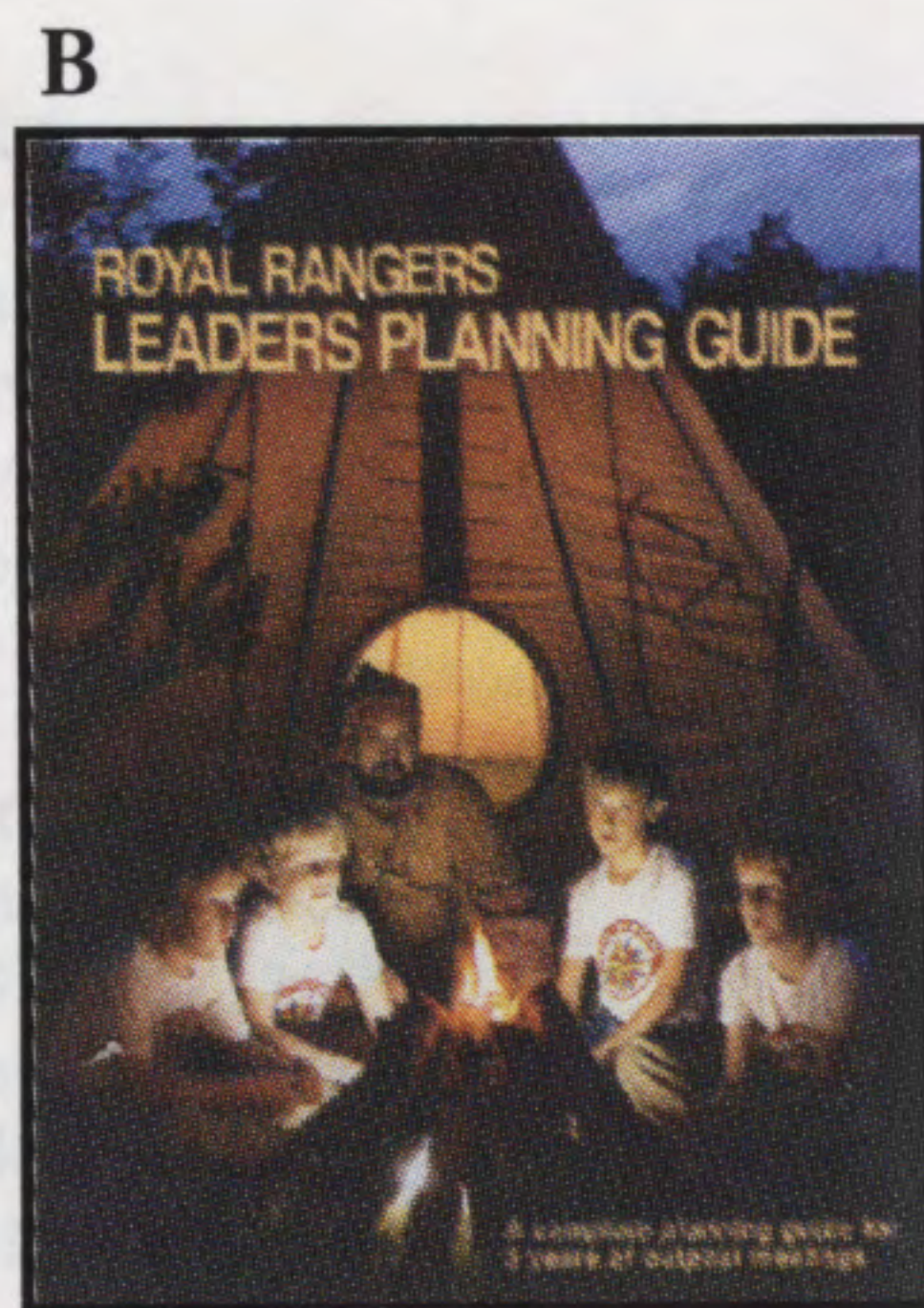

B. Royal Rangers Leaders Planning Guide. Outlines 3 years' worth of weekly meetings. Includes program ideas, inserts, and more. Paper. 02MX0669 \$5.95

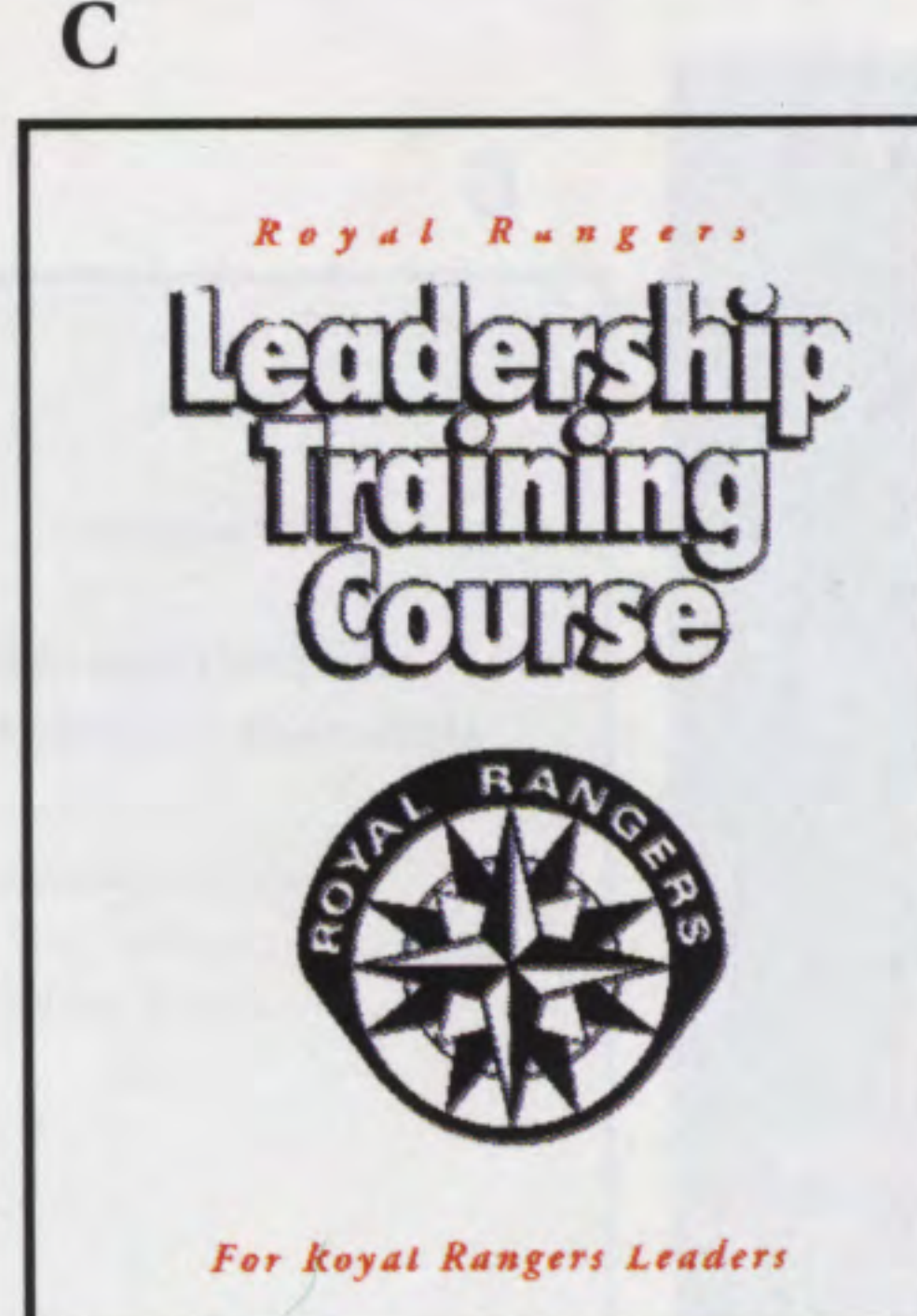

C. Royal Rangers Leadership Training Course, revised and updated. Helps Royal Rangers leaders reach, teach, and keep boys for Christ. Features 5 sections: Organization and Advancement, Understanding and Counseling Boys, Coordinating Your Royal Rangers Meetings, The Camping Program, and Teaching and Communication. Includes open-book tests. *Royal Rangers Leaders Manual, 02MX1037*, required to complete the course.

With binder 02MX0988 \$9.95
Without binder 02MX0987 \$6.50
See pages 3 & 4 for the Buckaroos-Straight Arrows Leadership Training Course

D. Royal Rangers Devotionals for Boys, Leaders Resource Book. Contains simple stories, illustrations, and demonstrations relating to spiritual truths. Most of the devotionals begin with a "purpose" statement to help leaders select an appropriate story and each ends with a "ceremony" that parallels the story to living for Christ. Paper. 02MX0714 \$5.50

E. Royal Rangers Bible Study Lessons. Designed to make Jesus Christ real to boys, to give them a biblical basis for their beliefs, to emphasize the points on the Royal Rangers emblem with Scripture references, and to make the nature world more meaningful through the study of the Bible. NIV text. Paper.

Volume 1 02MX0694
Volume 2 02MX0697
Volume 3 02MX0708
\$4.50 each

F. Royal Rangers Cadence of Christ Songs. 30 songs for casual sing-alongs or formal choral presentations. Selections include: *I'll Go, I'm Going To Shine My Light, Marching for the Lord, I See God Everyday, God Bless America, Vive L'Amour*, and more. Paper. Songbook 05MX0487 \$4.99
Cassette 28MX0198 \$12.99
Songbook & Cassette Combo Pack 05MX0488 \$16.99

G. Adventures in Camping. This revised manual is important reading for every Royal Ranger. Teaching boys and commanders what they need to know to have a safe and comfortable outing. Paper. 02MX1036 \$7.50

H. The Ultimate...Royal Rangers Brochure. Tells about the Royal Rangers program as well as what they must do to be saved. Includes invitation to attend a Royal Rangers meeting and a place to print contact information. Paper.

English 72MX9007
Spanish 72MX9010
100-799, 5¢ ea; 800-1,499, 4.5¢ ea; 1,500 or more, 4¢ ea.

I. Doorway to Action and Adventure Brochure. Designed to encourage men to become involved in the Royal Rangers program. Briefly tells about the different age-level programs and responsibilities. 72MX9020 50 for FREE additional tracts 8¢ ea.

J. Here's How Brochure. Explains the role of leaders within the church, from pastor to commander; how to become a chartered outpost; the importance of training; an outline for the first 3 meetings; and meeting suggestions. 72MX9021 10¢

K. Your Chartering Dollars Brochure. Tells the importance of chartering and benefits of being a chartered outpost. 72MX9008 50 for FREE additional tracts 8¢ ea.

L. Insight Group. For presentation to groups, Pioneers and up, this program is for youth who want to take an honest look at their lives and find help in areas they are struggling with. Explores issues such as trust, feelings, breaking down barriers, symptoms of life-controlling problems, and ways to say "no." Includes room for answering questions. 30 minute format. Comb binding. Commander's Guide 72MX9049 \$9.00 ea.; 10-19, \$8.00 ea.; 20 or more, \$7.50 ea.

Ranger's Guide/Workbook 72MX9050 \$7.00 ea.; 10-19, \$6.30 ea.; 20 or more, \$5.95 ea.

M. Victor's Victories. For presentation to Straight Arrows and Buckaroos. Addresses issues today's young boys face—building friendships, doing your best, being courteous, controlling anger, equality, and blended families. Provides 13 sessions, 4 skits, and reproducible coloring pages. 30-minute format. Comb binding. 72MX9057 \$18.00

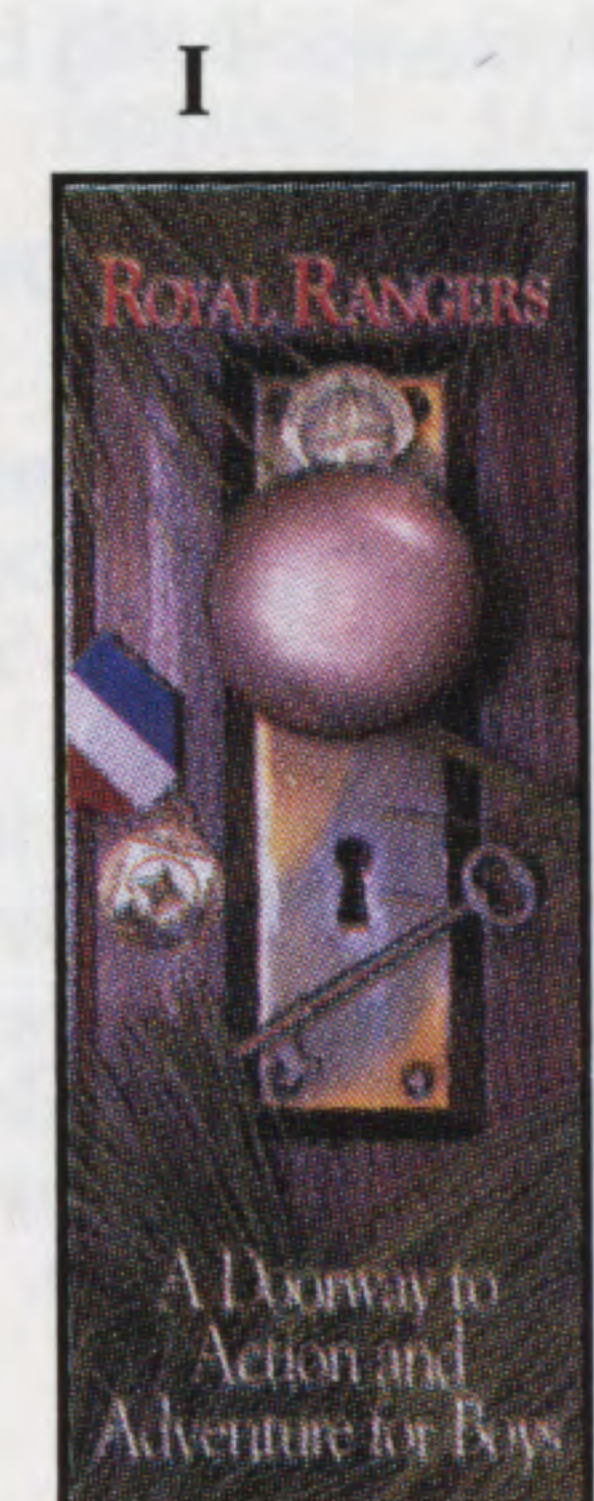
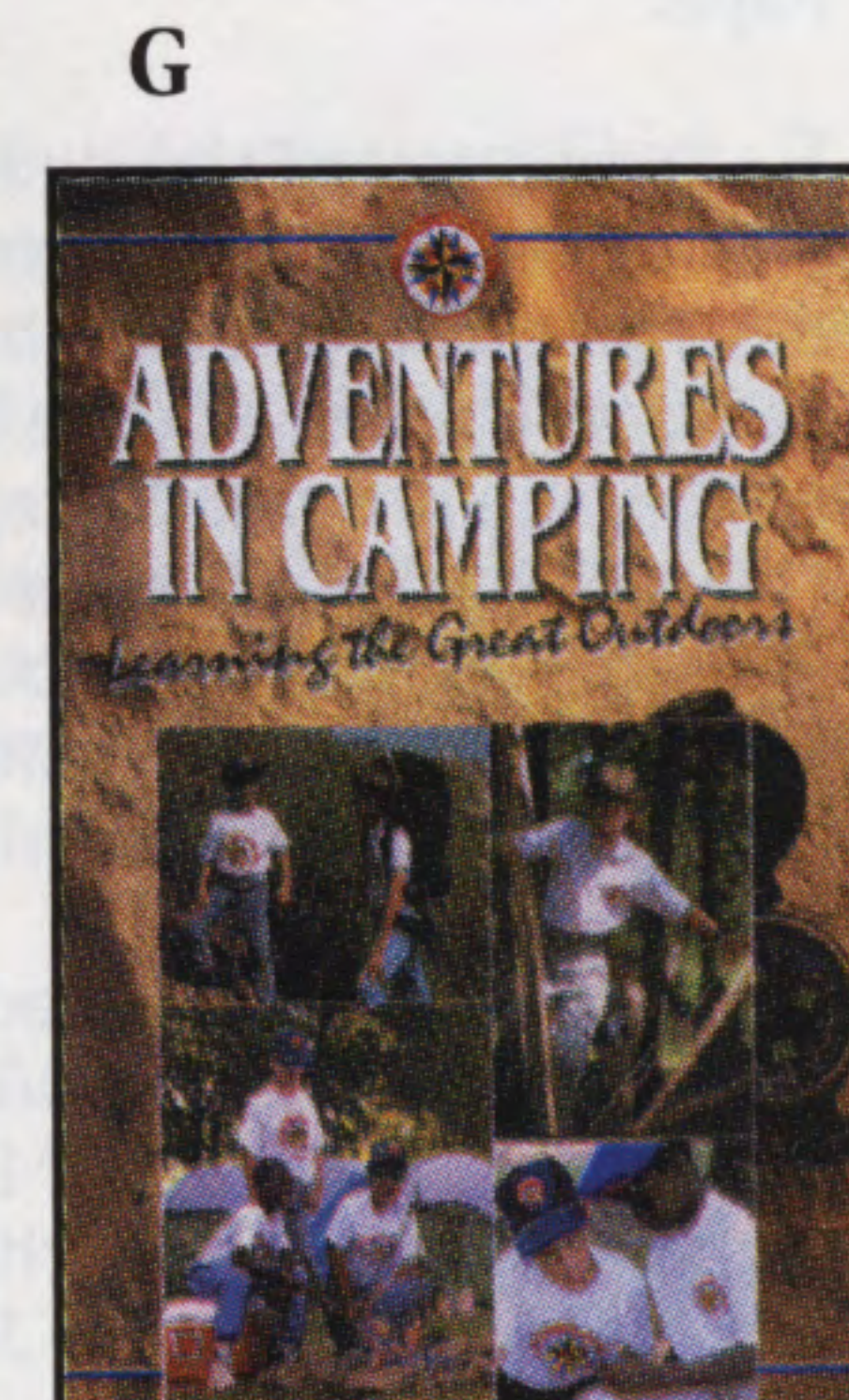
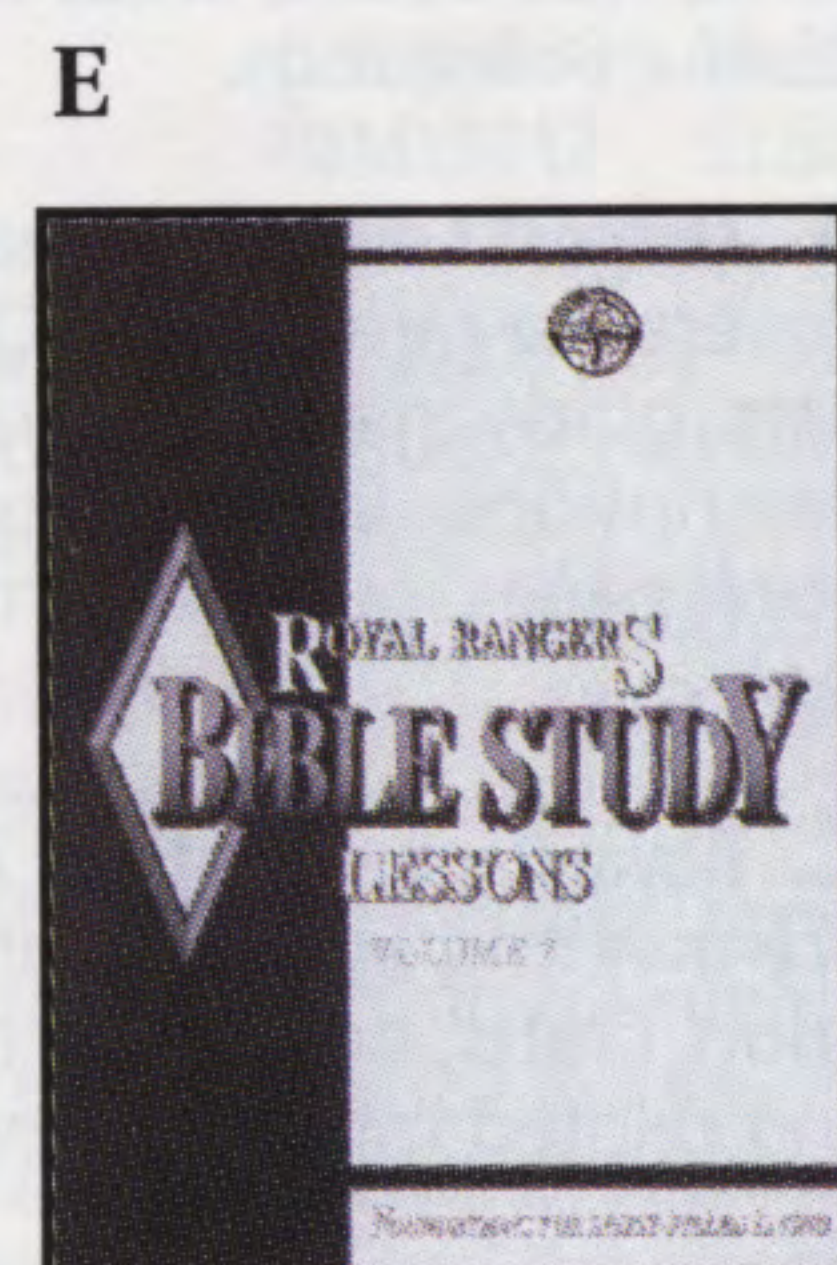
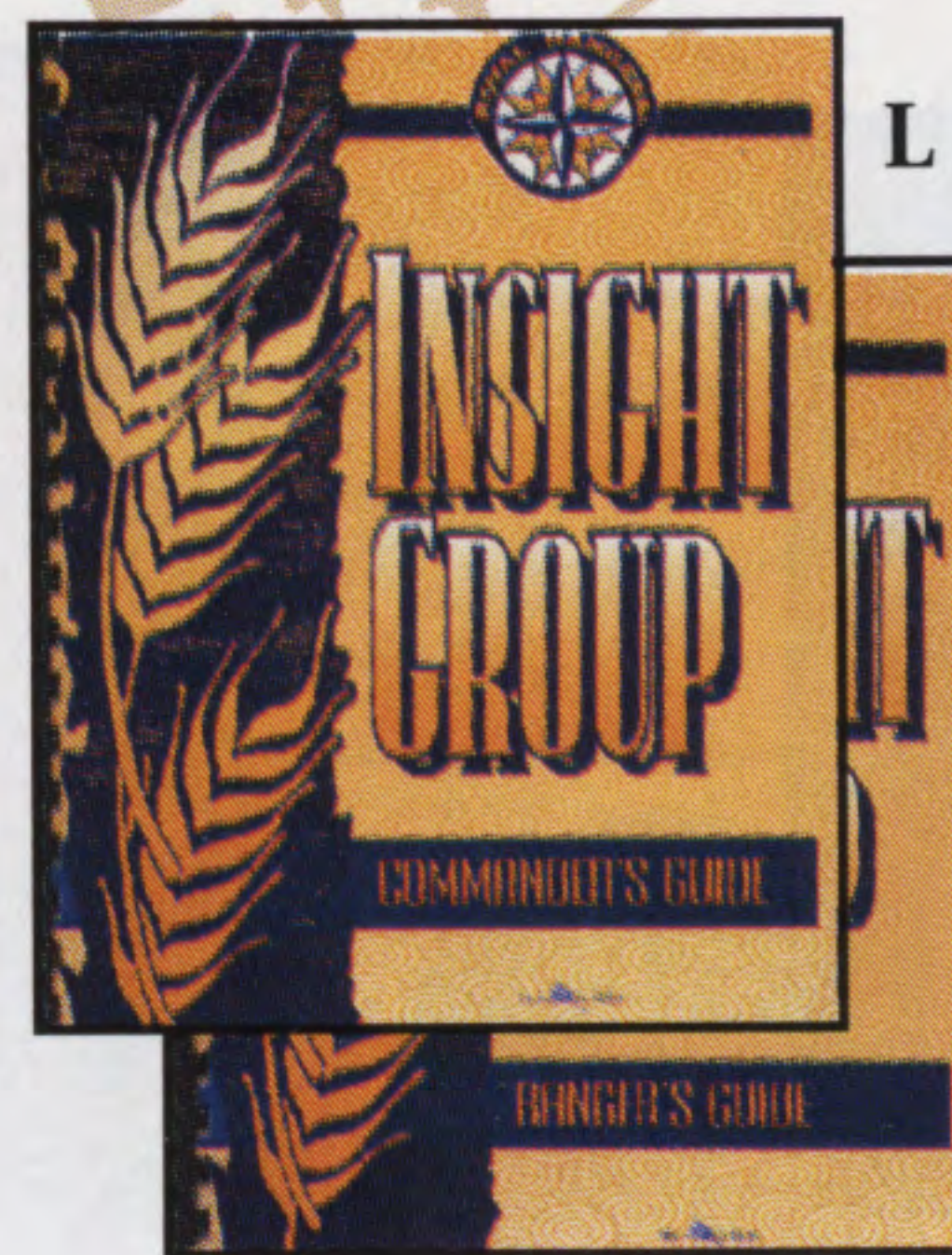
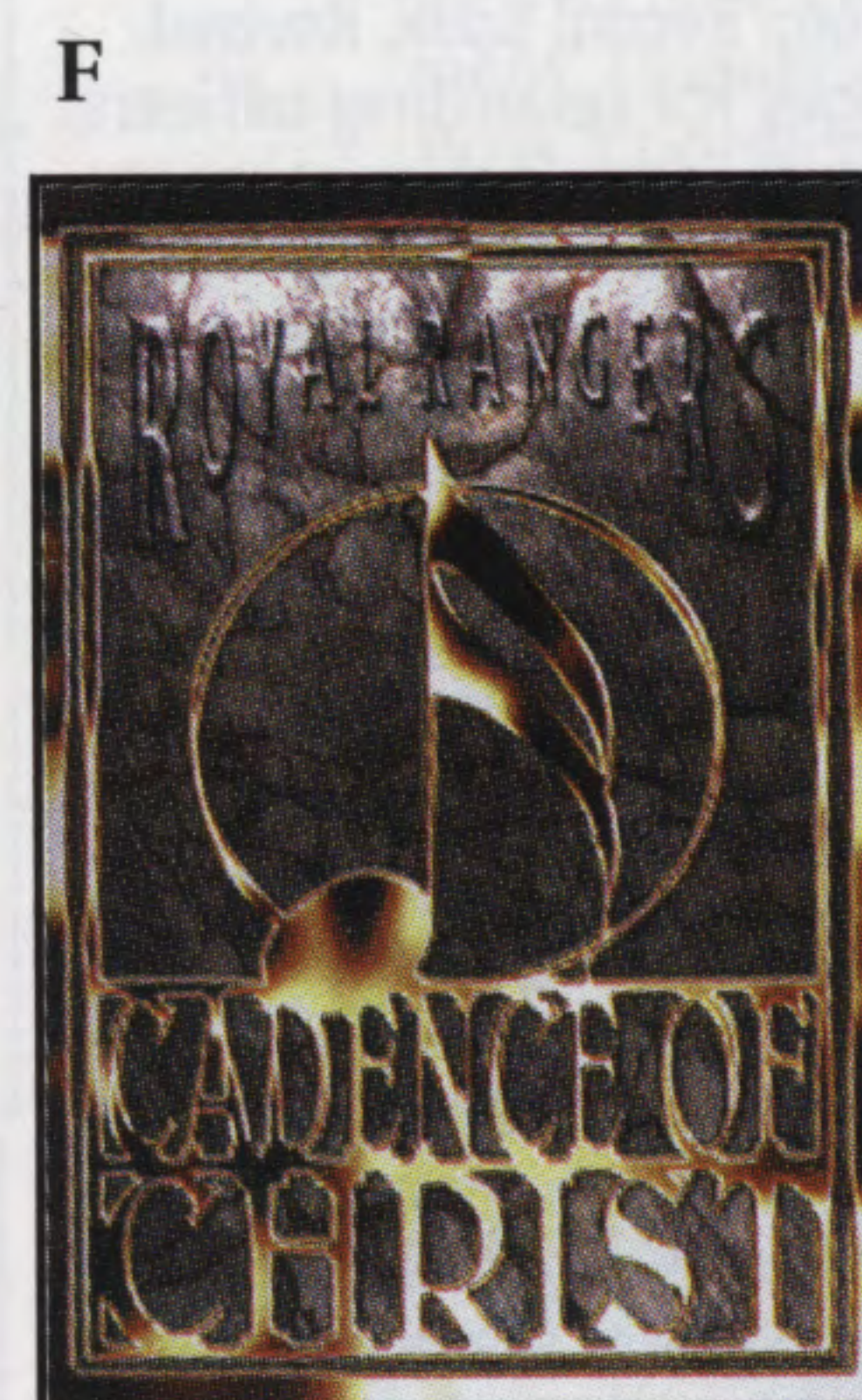
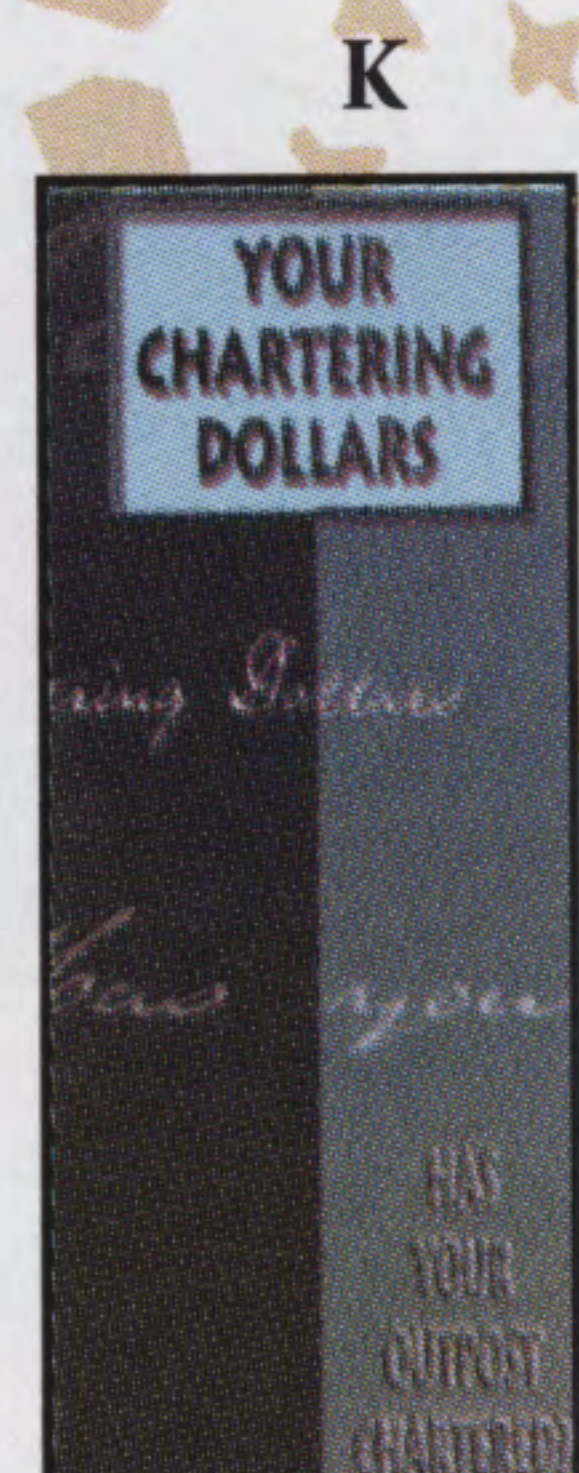

A. Your Outpost Council Brochure. Assists members of the Outpost Council. Tells who can serve, when to form, first duties, areas of responsibility, and how to conduct meetings. 72MX9022 6¢

B. Outpost Councilman Leadership Training Course. Covers the need for an Outpost Council, its members, guidelines, varied responsibilities, and job descriptions. Includes comprehensive review/workbook pages, outpost forms, and final test. Loose-leaf. 72MX9011 \$5.00 ea; 5 or more, \$4.00 ea.

C. Royal Rangers Outpost Activities Book. Covers pre-meeting activities, program features, recreation, crafts, outdoor activities, campfire meetings, and related topics. Paper. 02MX0709 \$6.99

D. Royal Rangers Outpost Group Record Book, Revised, Updated. Provides ruled pages for recording officers, attendance, dues, expenses, income, advancement awards, special activities, decisions, and other information. Paper. 07MX5263 \$1.95

E. Frontiersmen Camping Fellowship Brochure. Tells the purpose of FCF, the skills emphasized, what FCF symbols stand for, and how boys and men can join. Paper. 72MX9018 10¢

F. Frontiersmen Camping Fellowship Handbook, Revised. Introduces the FCF Program and provides detailed descriptions of frontier traditions and skills. Features 2 sections. The first section tells the history of FCF, the program's steps, and frontiersman skills. The second section helps members master many skills, including shelter building, fire starting, outfitting, making jerky and pemmican, and storytelling. Includes color illustrations. Paper. 02MX1048 \$6.50

G. Our Church Heritage Packet. Includes 3 brochures: The Assemblies of God: The Local Church, The Assemblies of God: Our Distinctive Doctrine—The Baptism in the Holy Spirit, and The Assemblies of God: Our 16 Doctrines. Paper. 72MX9006 \$2.50

H. Prevention Resource Guide. Leader's study designed to help people avoid life-controlling problems, such as alcohol, inhalants, steroids, and pornography. Includes discussions on leading a prevention group, diagnosing your walk with God, decision making, counseling adolescents, and steering clear of and understanding life-controlling problems. 3-ring binder. 72MX9056 \$35.00

ROYAL RANGERS VIDEOS

Royal Rangers Videos. Provide an overview of the Royal Rangers program and encourage involvement. Approx. 4-5 min.

One in a Million. A lonely boy joins Royal Rangers and finds activities, friends, and Jesus. Set to music. 72MX9046 \$15.00

Reaching Boys for Christ. Highlights the activities, goals, responsibilities, and effectiveness of the Royal Rangers program. 72MX9128 \$10.00

H

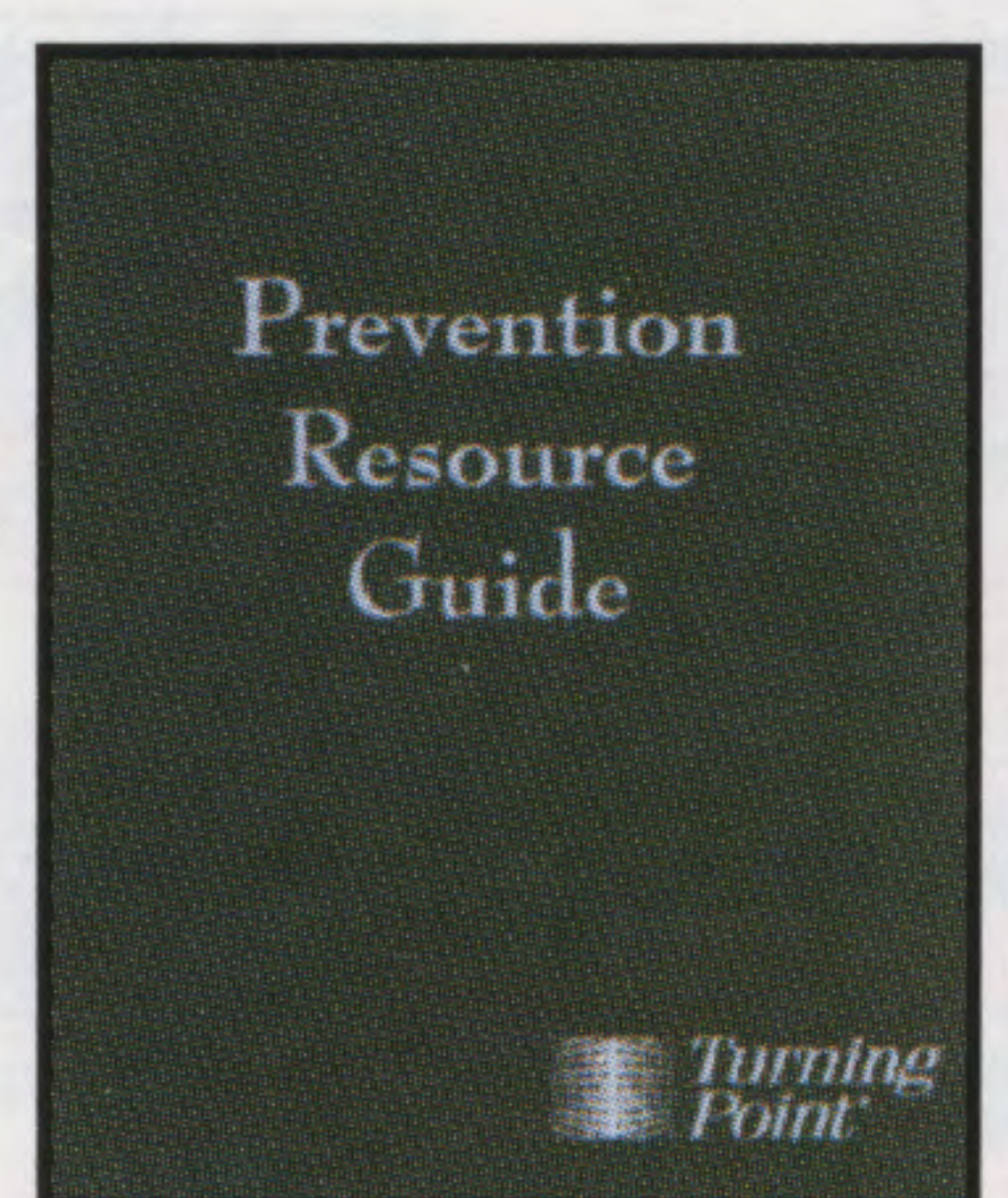

A



B

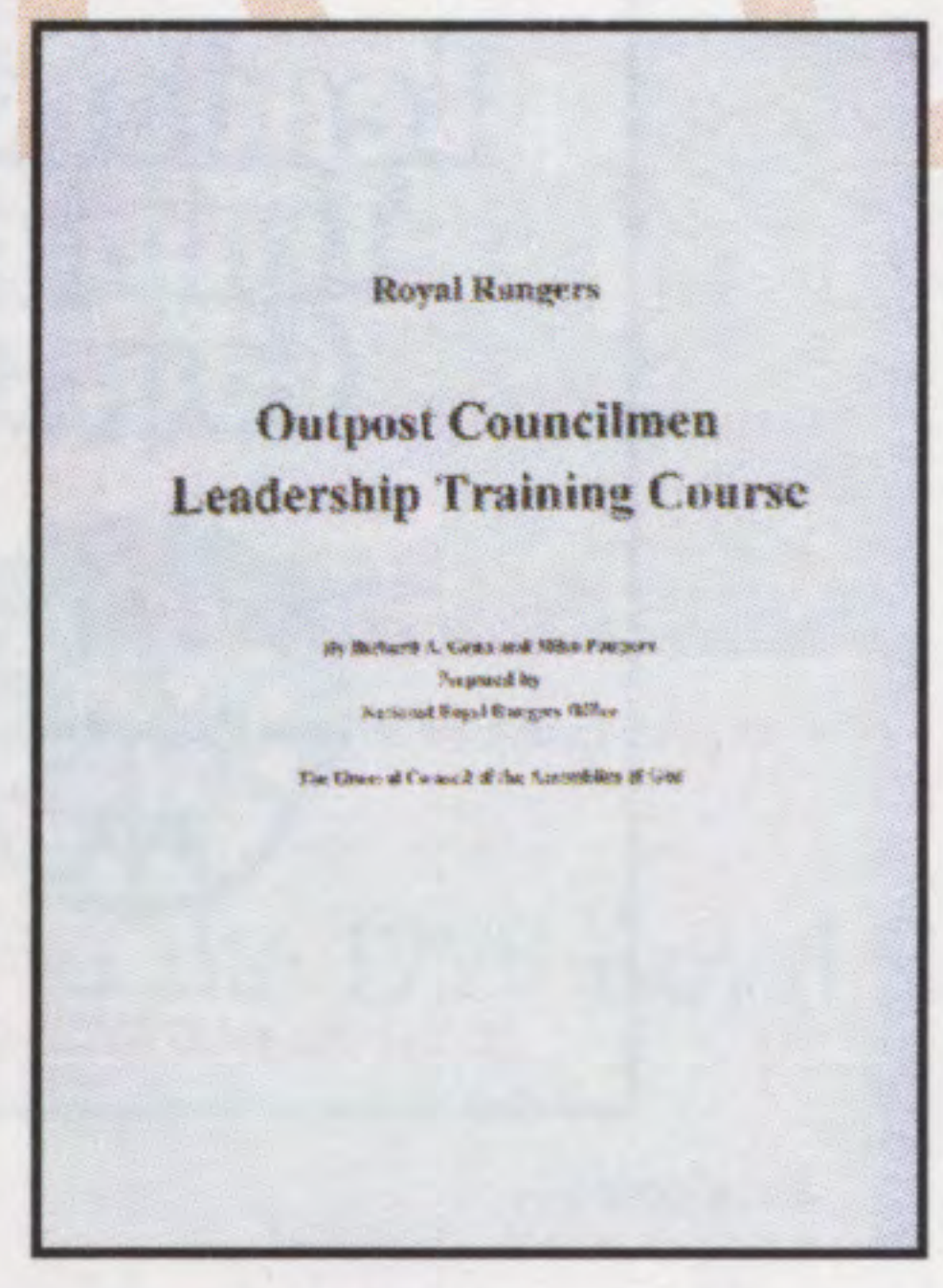

C

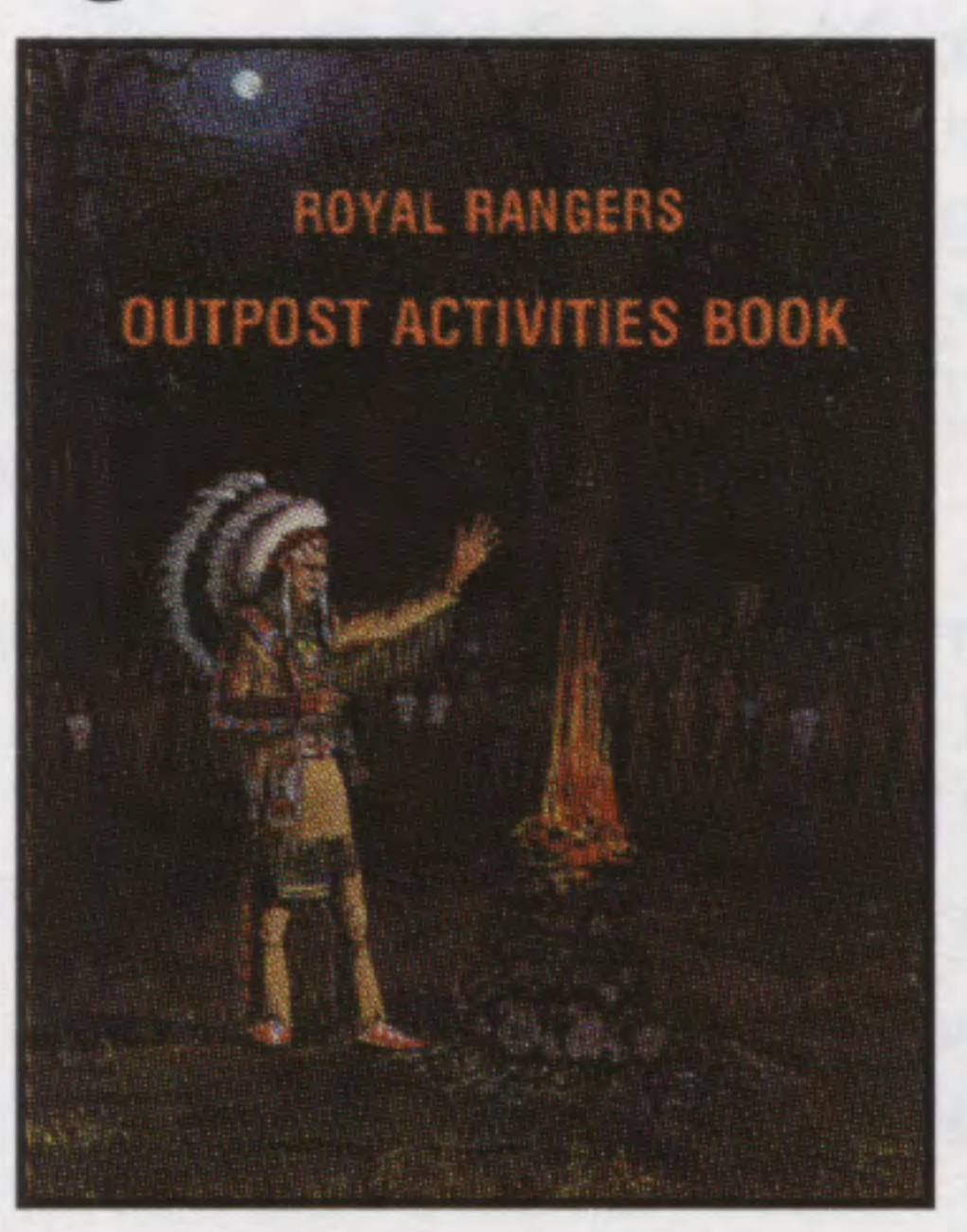

D

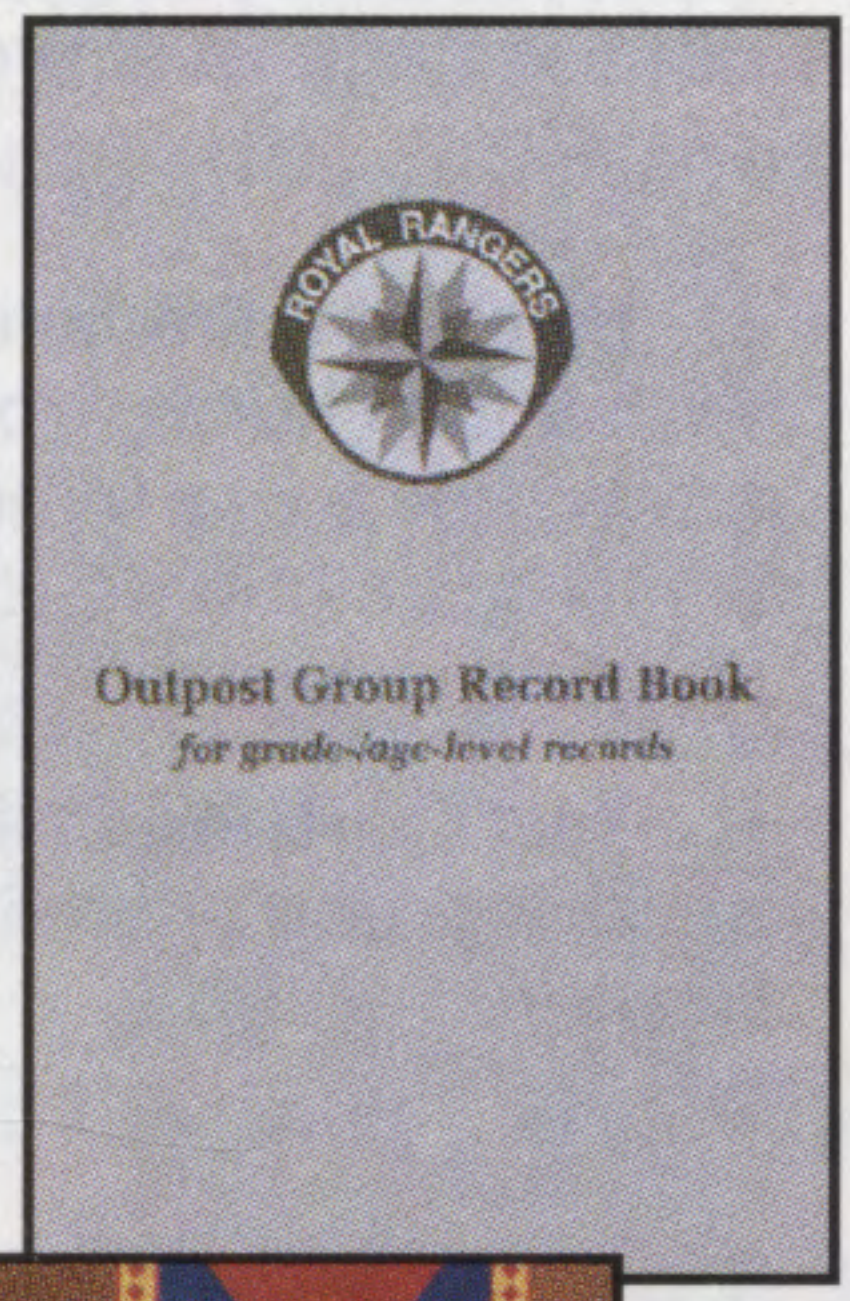

E



F

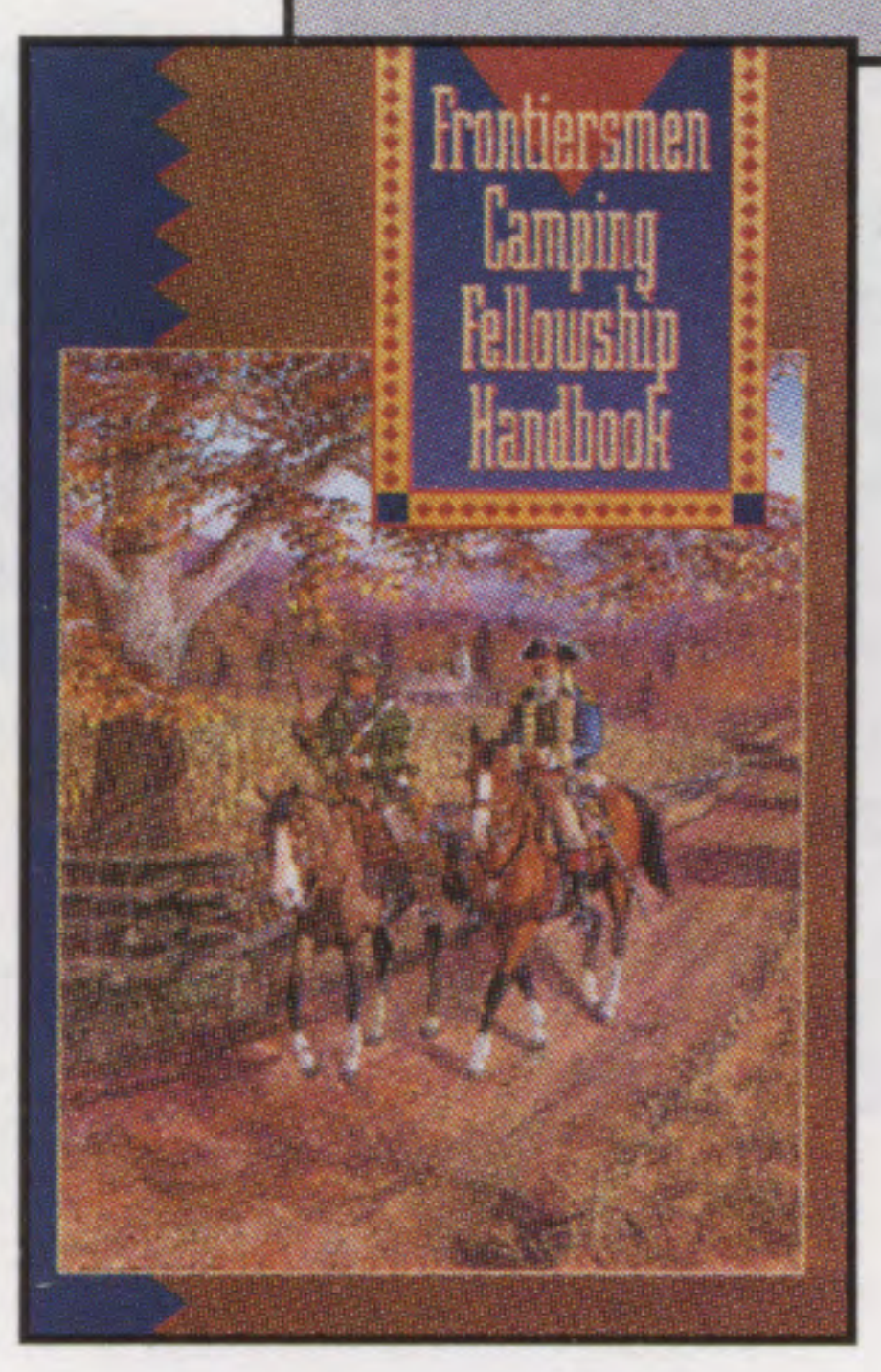

G



I



ROYAL RANGERS SOFTWARE

Royal Rangers Computer Presentation. Enables commanders to promote Royal Rangers. Two 3.5" disks provide a continual run program with photos and color graphics depicting various activities and ages. 72MX9051 \$35.00

Royal Rangers Clip Art Diskette. 3.5" DOS disk filled with 200 pcx images, including badges, names, and activities. Ideal for worksheets, newsletters, and other printed pieces. Requires PC XT or higher and a graphics or desktop publishing program that allows editing or importing of .pcx images. 72MX9048 \$15.00

Rangers WinTracker, 3.5" Windows Disk. Tracks Royal Rangers' advancements and profiles—new and old Advancement Trail. 72MX9140 \$65.00

Rangers Trailtracer, 3.5" DOS Disk. Enables tracking of Royal Rangers' advancements and profiles—new Advancement Trail. 72MX9141 \$45.00

Rangers Color Clip Art, Vol. 1. Royal Rangers logos, medals, junior and national training camp symbols, and black-and-white clip art. 29 symbols, in 2 formats: Tiff Bitmap and Windows Metafile. 72MX9003 \$20.00

GOD AND COUNTRY PROGRAM

I. Encourages a positive relationship between young people and the Church. The **Adult Mentor Packets** give instruction to pastors preparing adults to train children. It also includes a copy of the student materials. The **Counselor's Manuals** feature a session-by-session guidance section for counselors. Awards are given for program completion.

God and Me. For ages 6-8. Encourages the understanding of how we are made, why, and a child's relationship with God. Features 3 projects and 3 study sections which are offered in the student materials. 3-hole punched.

| | | |
|-------------------------|----------|--------|
| Student Resource Packet | 08MX0249 | \$3.25 |
| Counselor's Manual | 08MX0248 | \$3.25 |
| Adult Mentor Packet | 08MX1096 | \$3.25 |
| Medal | 15MX0365 | \$5.25 |
| Pin | 15MX0367 | \$3.75 |

God and Family. For ages 9-10. Offers 6 sessions which encourage Christian nurturing in the home and church. Examines God and family, friends, future, and other areas. 3-hole punched.

| | | |
|-------------------------|----------|--------|
| Student Resource Packet | 08MX0234 | \$3.25 |
| Counselor's Manual | 08MX0233 | \$3.25 |
| Adult Mentor Packet | 08MX1097 | \$3.25 |
| Medal | 15MX0404 | \$5.25 |
| Pin | 15MX0405 | \$3.75 |

God and Church. For ages 11-14. Provides an opportunity to get to know the pastor and counselor on a more personal basis. Helps boys understand their church's structure, objectives, and mission. Student Resource Packet is divided into 2 sections: God and His work, and Christians and their work. 3-hole punched.

| | | |
|-------------------------|----------|--------|
| Student Resource Packet | 08MX0236 | \$3.25 |
| Counselor's Manual | 08MX0235 | \$3.25 |
| Adult Mentor Packet | 08MX1098 | \$3.25 |
| Medal | 15MX0406 | \$5.25 |
| Pin | 15MX0407 | \$3.75 |

God and Life. For ages 15-20. Offers exercises for students wanting to increase their faith; make responsible vocational choices; and find identity in family, church, and country. Includes a 6-section study for teens with activities. 3-hole punched.

| | | |
|-------------------------|----------|--------|
| Student Resource Packet | 03MX3880 | \$3.25 |
| Counselor's Manual | 03MX3870 | \$3.25 |
| Adult Mentor Packet | 08MX1099 | \$3.25 |
| Medal | 15MX0408 | \$5.25 |
| Pin | 15MX0409 | \$3.75 |

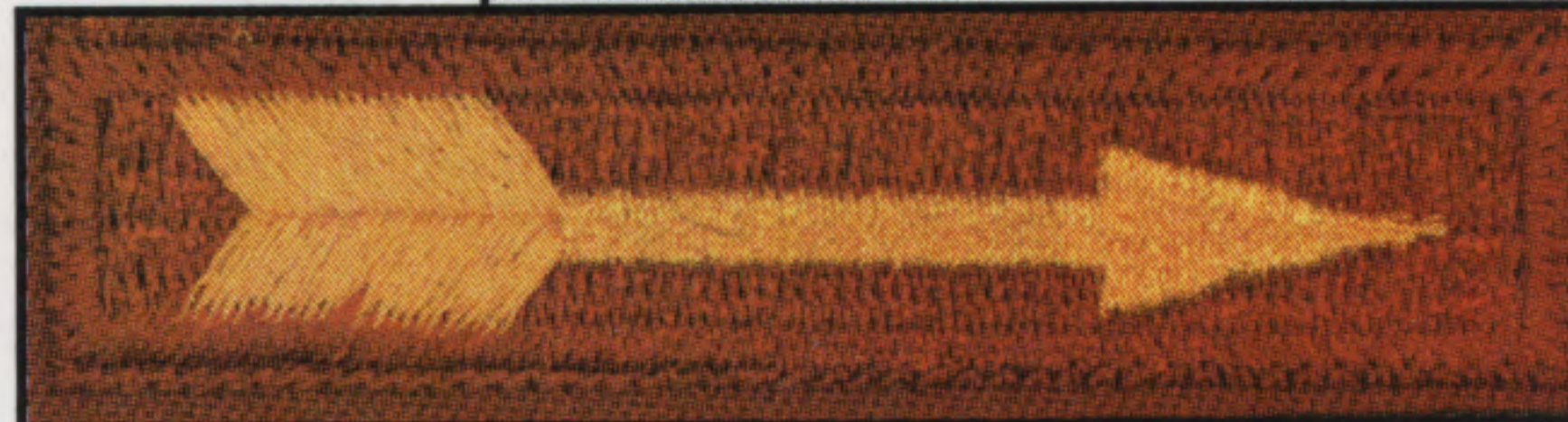
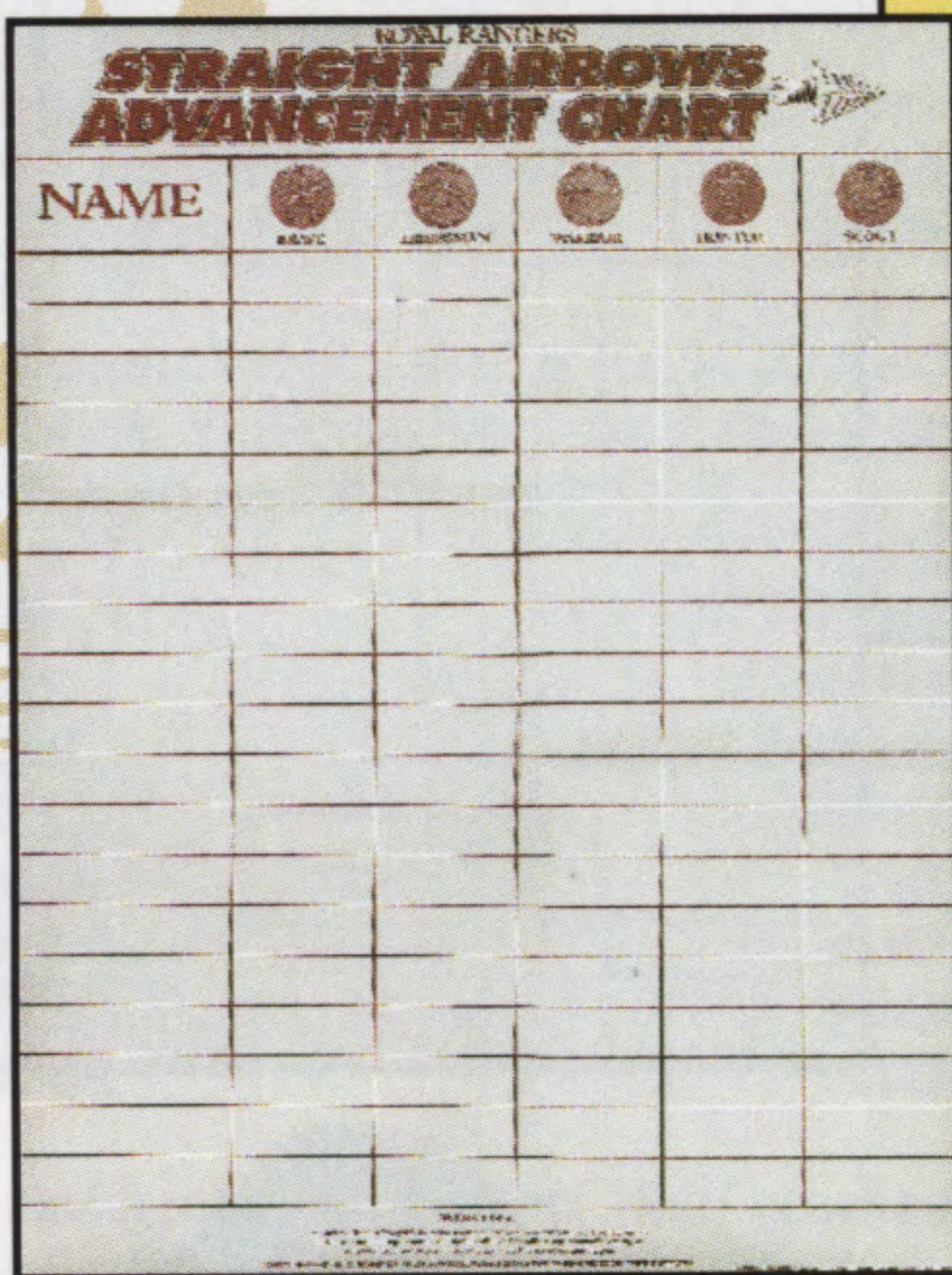
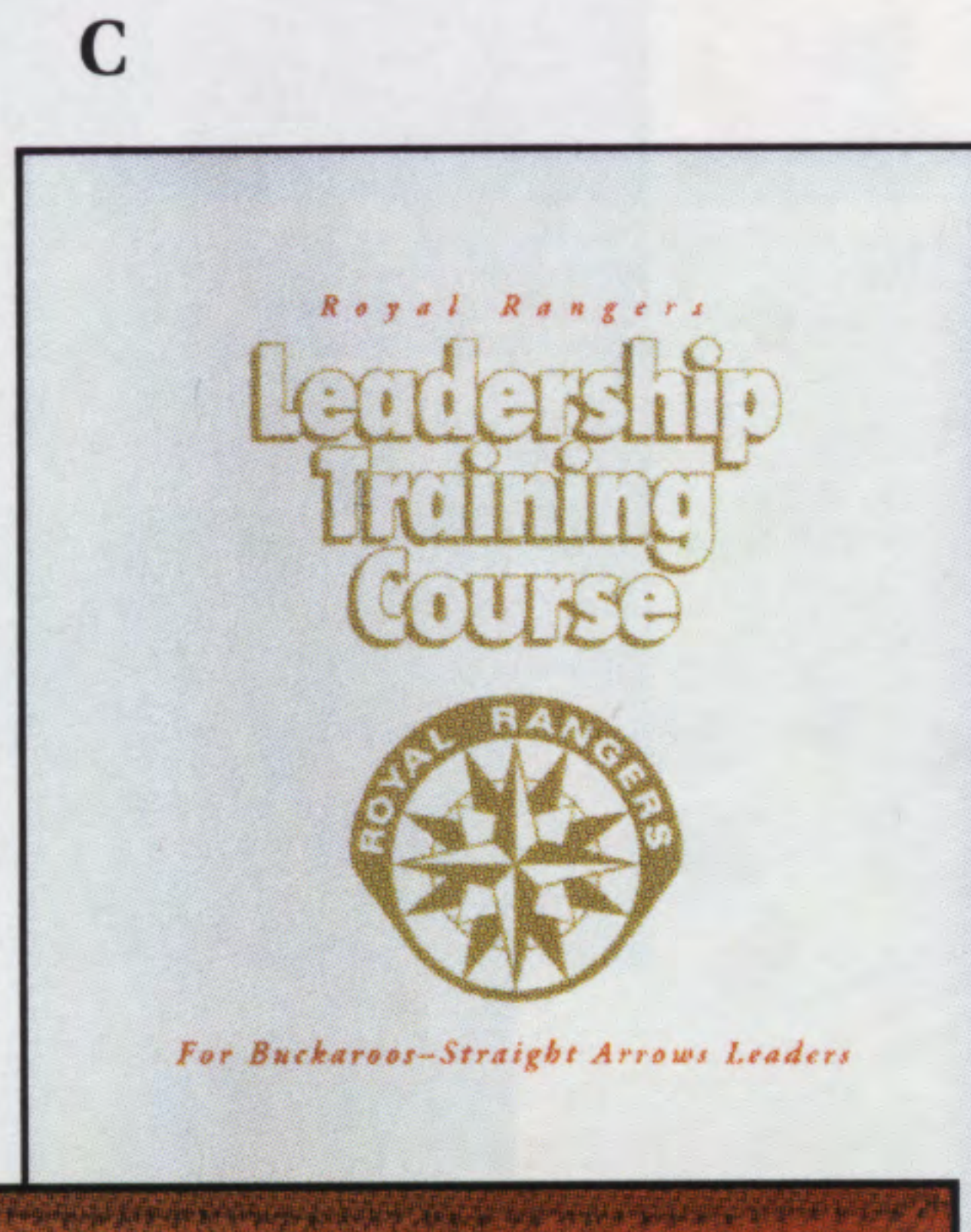
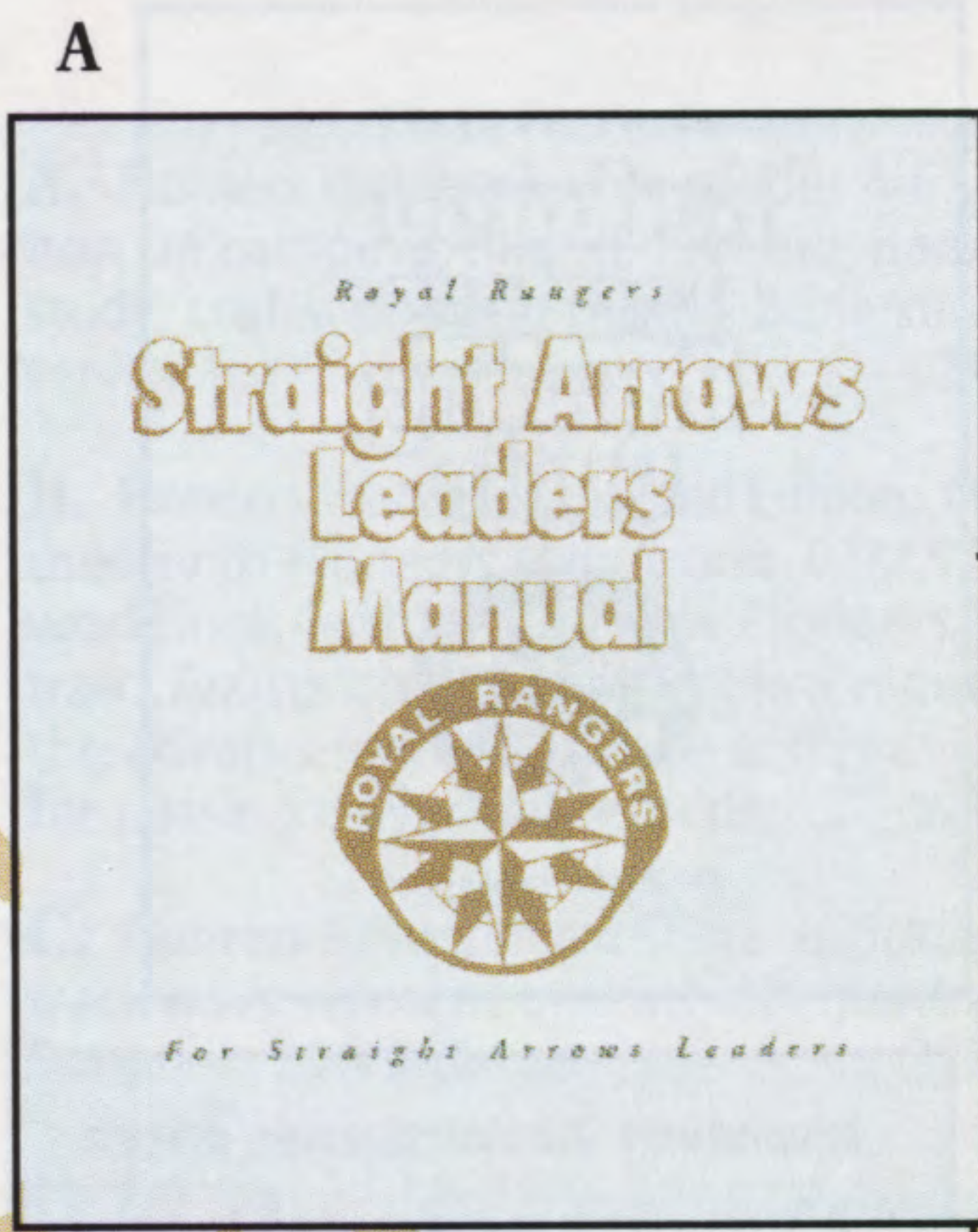

A. Straight Arrows Leaders Manual. 2 full years of Straight Arrows programs in one manual.
 With binder 02MX0690 \$9.95
 Without binder 02MX0656 \$6.95
 Binder only 08MX0212 \$3.50

B. Straight Arrows Handwork Packets. Each boy uses this packet instead of a handbook. Has one craft project for each meeting.
 First Year 18MX7590
 Second Year 18MX7591
 \$4.50 each

C. Buckaroos-Straight Arrows Leadership Training Course. A 5-section leadership training course developed specifically for Buckaroos and Straight Arrows leaders. Sections include Organization and Advancement, Understanding and Counseling Boys, Coordinating Royal Rangers Meetings, The Camping Program, and Teaching and Communication. Includes open-book tests. *Royal Rangers Leaders Manual, 02MX1037, page 1, required to complete course.*
 With binder 02MX0990 \$9.95
 Without binder 02MX0989 \$6.50

D. Straight Arrows Advancement Chart. Includes achievement awards and has space for 18 boys' names and accomplishments. 20 x 26" 23MX8811 \$1.95

E. Straight Arrows Insignia. Gold arrow embroidered on a red background. Wear beneath small Royal Rangers emblem on right side of vest. 3/4 x 3 1/4" 15MX0403 75¢

F. Straight Arrows Advancement Pins.
 Brave. Level 1 15MX6969
 Tribesman. Level 2 15MX6971
 Warrior. Level 3 15MX6978
 Hunter. Level 4 15MX6970
 Scout. Level 5 15MX6968
 \$1.95 each

G. Straight Arrows T-shirt. White shirt with red neck and sleeve ribbing. Features colorful Royal Rangers and Straight Arrows design. 50% polyester and 50% cotton.
 Boys XS 08MX0660 \$7.99
 Boys S (6-8) 08MX0661 \$7.99
 Boys M (10-12) 08MX0662 \$7.99
 Adult S 08MX0788 \$8.99
 Adult M 08MX0789 \$8.99
 Adult L 08MX0790 \$8.99
 Adult XL 08MX0791 \$8.99
 Adult 2XL 08MX0792 \$9.99
 Adult 3XL 08MX1731 \$12.50
 Adult 4XL 08MX1732 \$16.50

H. Straight Arrows Vest. 100% polyester with a soil release feature. Royal Rangers emblem and arrow already sewn on the upper right-hand side. Red.
 Small 6 24" 08MX0434
 Medium 8 25" 08MX0435
 Large 10 26" 08MX0436
 \$7.95 each



A. Buckaroos Leaders Handbook. Designed for Buckaroos leaders as a supplement to the *Royal Rangers Leaders Manual*, 02MX1037, page 261. Paper.

02MX0691 \$3.99

B. Buckaroos Handbook. For grades 2-3. Guides boys through the program. Includes advancement instructions, lessons in practical living, and activity suggestions. Paper.

02MX0681 \$2.50

C. Buckaroos Leaders Planning Guide. Offers lessons for every week of the year. Includes many craft ideas.

With binder 02MX1052 \$13.50

Without binder 02MX1049 \$11.95

Binder only 08MX0201 \$3.50

D. Buckaroos Handwork Packet. Use in conjunction with weekly meetings. Features puzzles, mazes, and other activities.

18MX7610 \$3.95

E. Buckaroos-Straight Arrows Leadership Training Course. A 5-section course developed specifically for Buckaroos and Straight Arrows leaders. Sections include: Organization and Advancement, Understanding and Counseling Boys, Coordinating Royal Rangers Meetings, The Camping Program, and Teaching and Communication. Includes open-book tests. *Royal Rangers Leaders Manual*, 02MX1037, page 1, required to complete course.

With binder 02MX0990 \$9.95

Without binder 02MX0989 \$6.50

F. Buckaroos Advancement Chart. Track the accomplishments and achievement awards of 18 boys on this poster-sized chart. 20 x 26"

23MX8804 \$1.95

G. Buckaroos Shirt. Fine quality red shirt made of 65% polyester and 35% cotton. Western-style cut. See page 13 for adult sizes.

Size 6 (12 x 21 1/2) 08MX0315

Size 8 (12 1/2 x 23 1/2) 08MX0301

Size 10 (13 x 25 1/2) 08MX0302

Size 12 (13 1/2 x 27 1/2) 08MX0303

Size 14 (14 x 29 1/2) 08MX0304

Size 16 (14 1/2 x 31 1/2) 08MX0299

\$14.50 each

H. Buckaroos Neckerchief. Yellow with the Royal Rangers emblem and the name "Buckaroos" printed on the back.

08MX0287 \$4.95

I. Buckaroos Neckerchief Slide. Durable, white plastic, imprinted in red with the Buckaroos Top Hand emblem.

08MX0288 \$1.25

J. Buckaroos Advancement Pins.

Greenhorn. Steer head 15MX0256

Wrangler. Boots 15MX0257

Range Rider. Saddle 15MX0258

Top Hand. Horse and Rider 15MX0259

\$2.25 each

K. Buckaroos T-shirt. White shirt with yellow neck and sleeve ribbing. Colorful design of boy on bucking pony surrounded by lariat; Buckaroos and Royal Rangers emblems incorporated in design.

50% polyester and 50% cotton.

Boys S (6-8) 08MX0663 \$7.99

Boys M (10-12) 08MX0664 \$7.99

Boys L (14-16) 08MX0665 \$7.99

Adult S 08MX0793 \$8.99

Adult M 08MX0794 \$8.99

Adult L 08MX0795 \$8.99

Adult XL 08MX0796 \$8.99

Adult 2XL 08MX0797 \$9.99

Adult 3XL 08MX1733 \$12.50

Adult 4XL 08MX1734 \$16.50

Adult Buckaroos uniform is found on page 13.

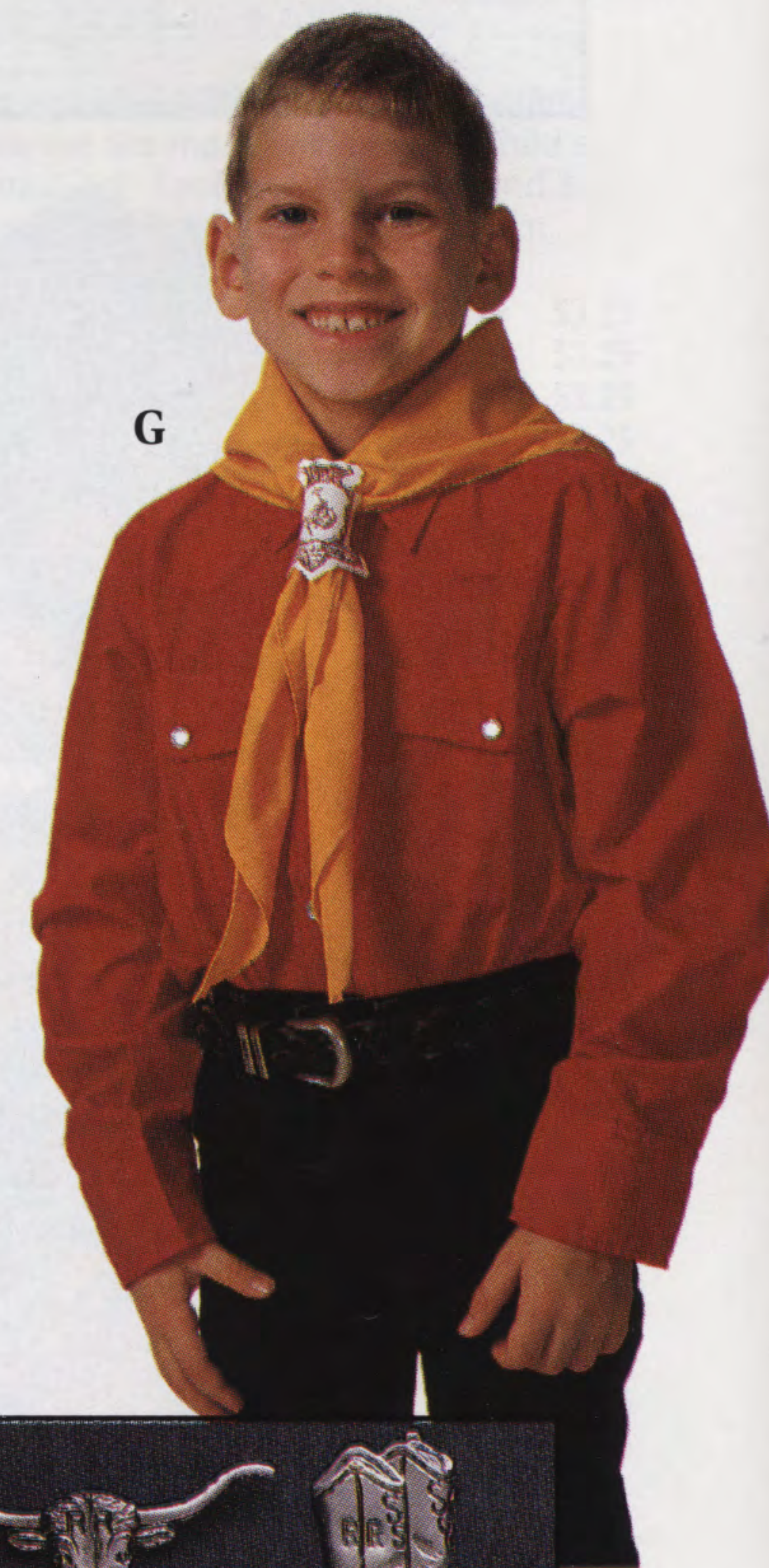
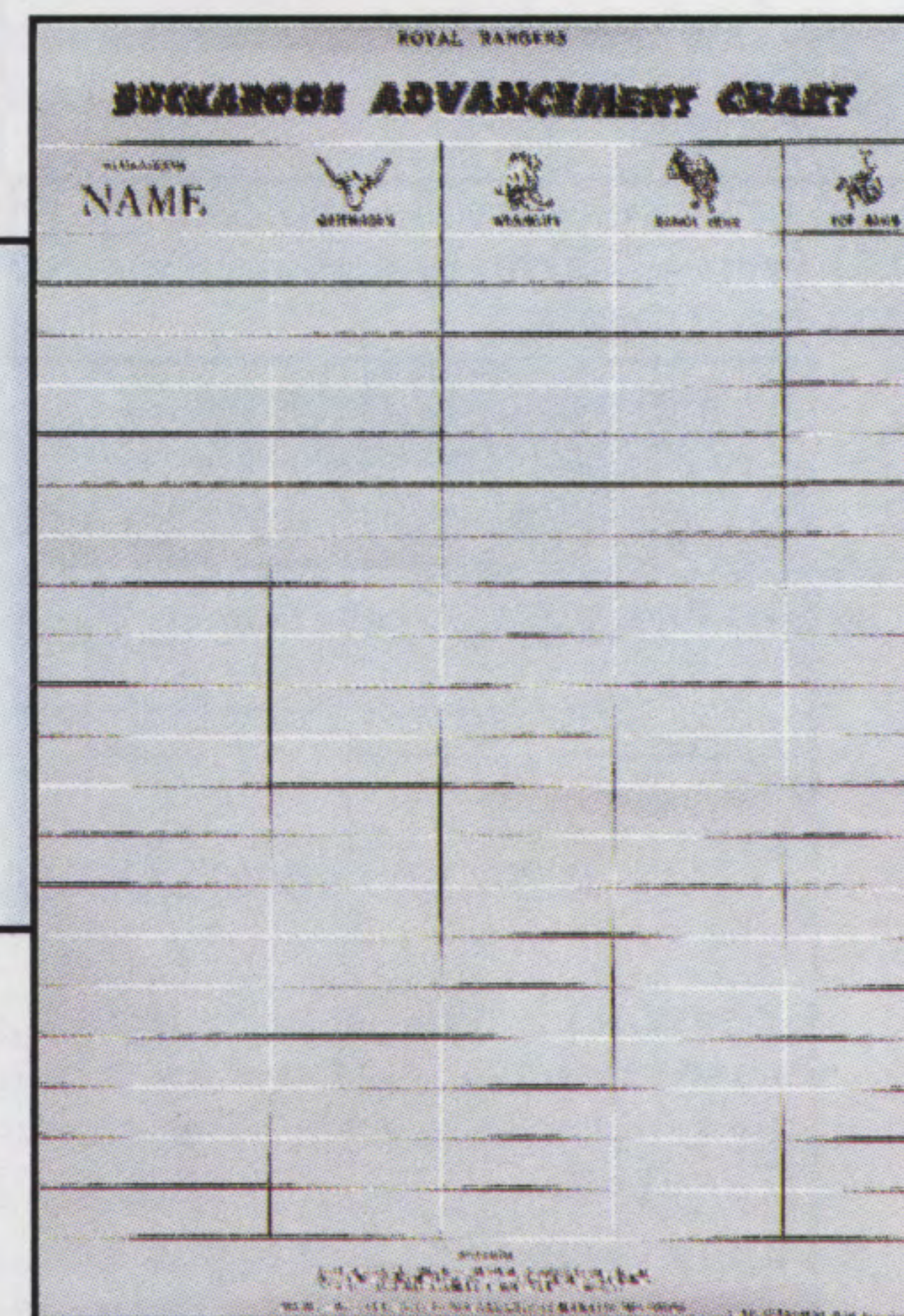
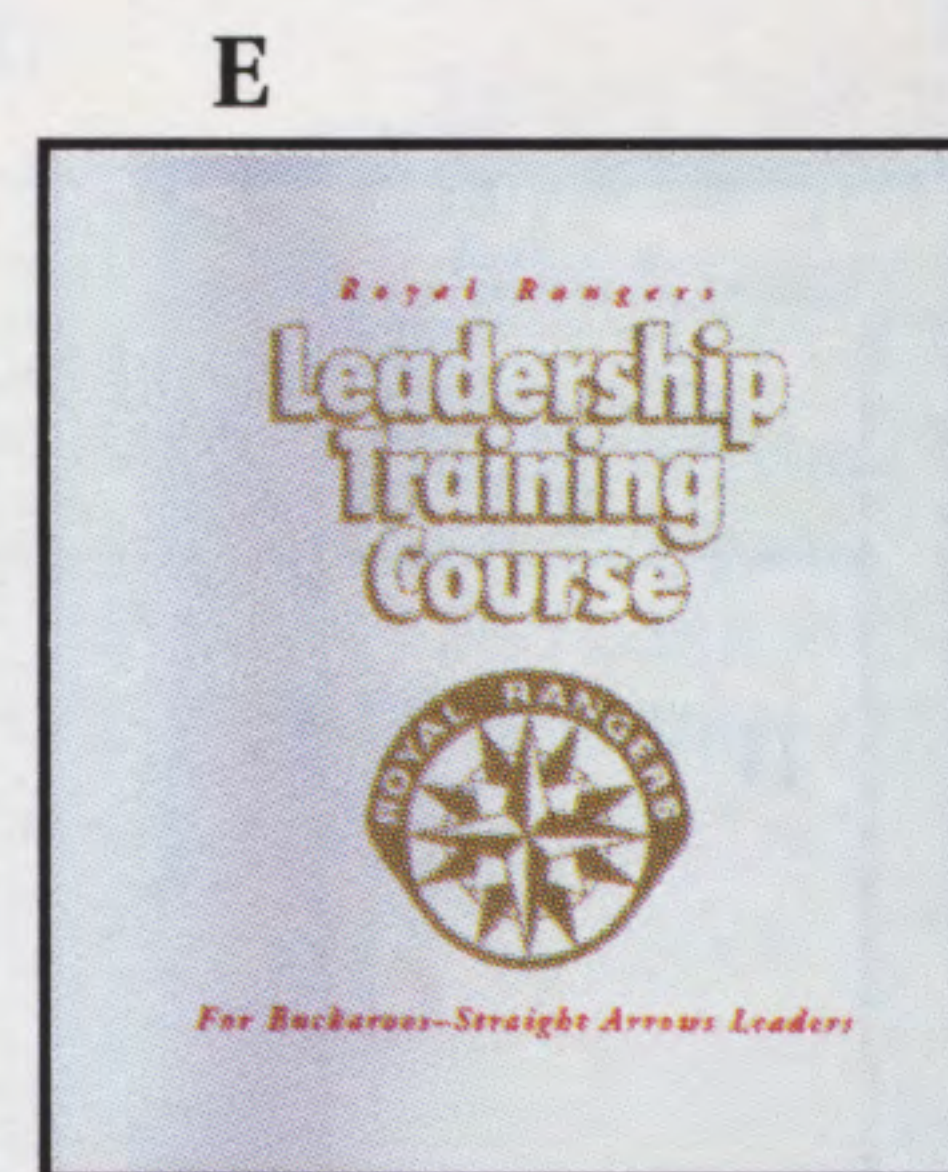
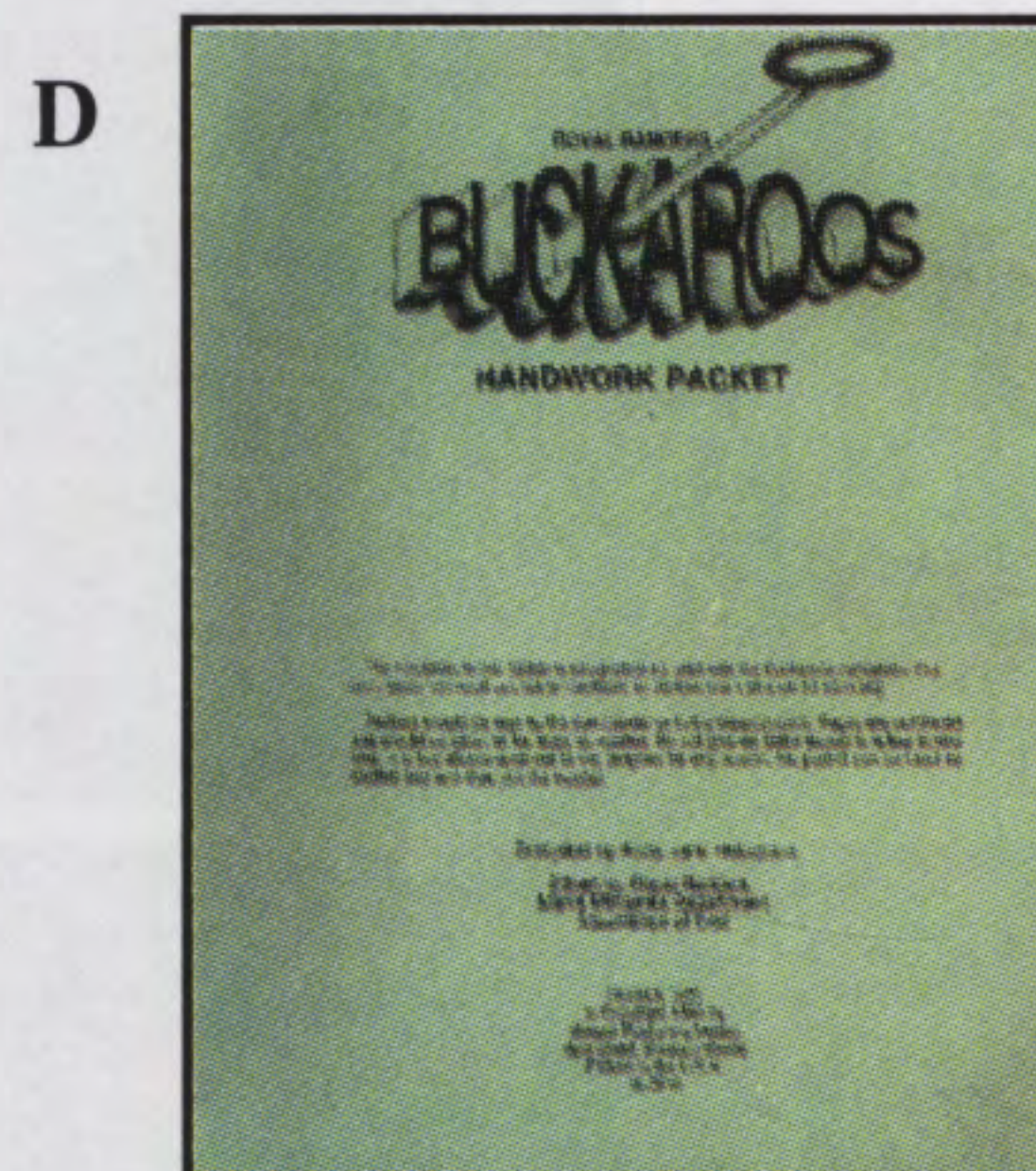
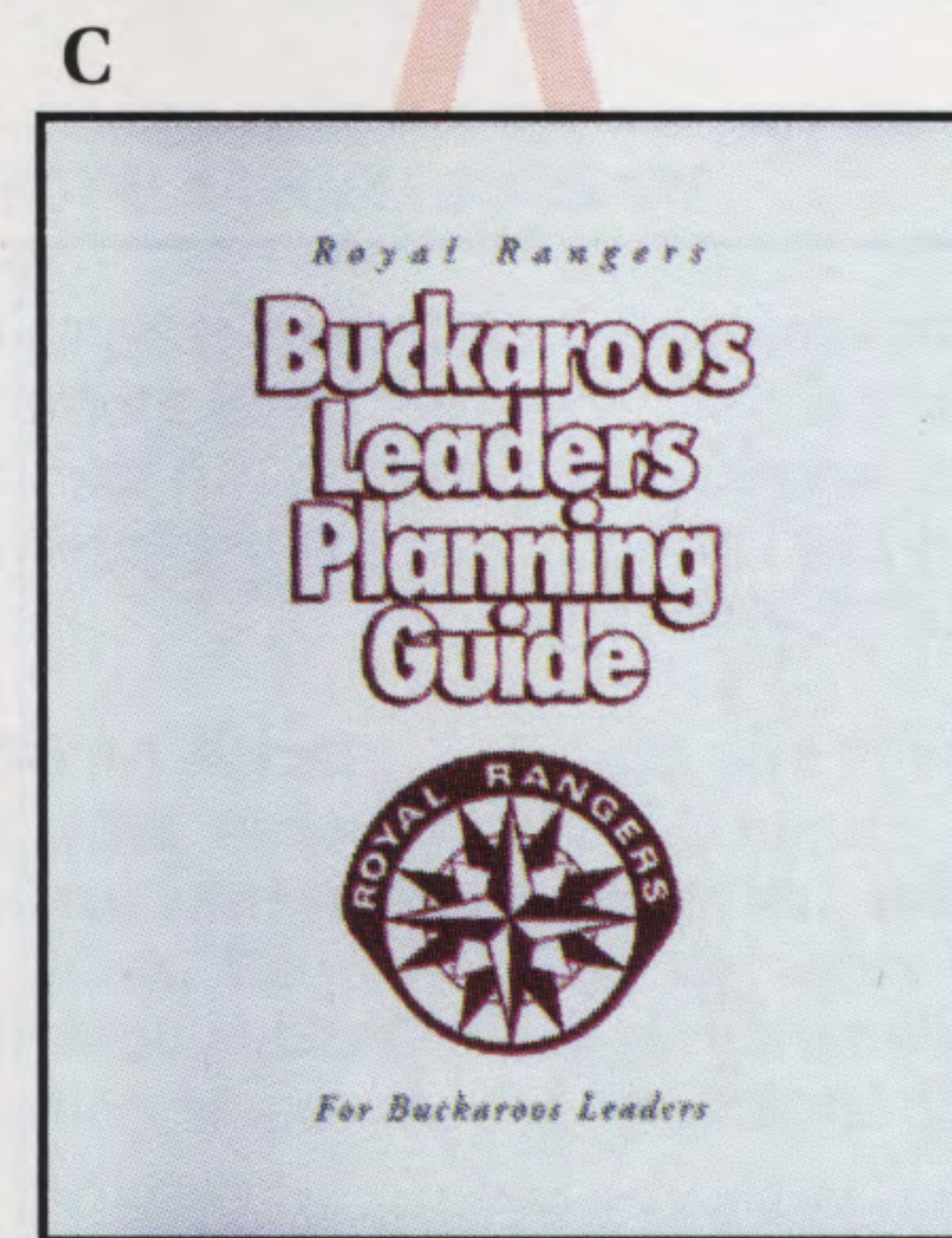
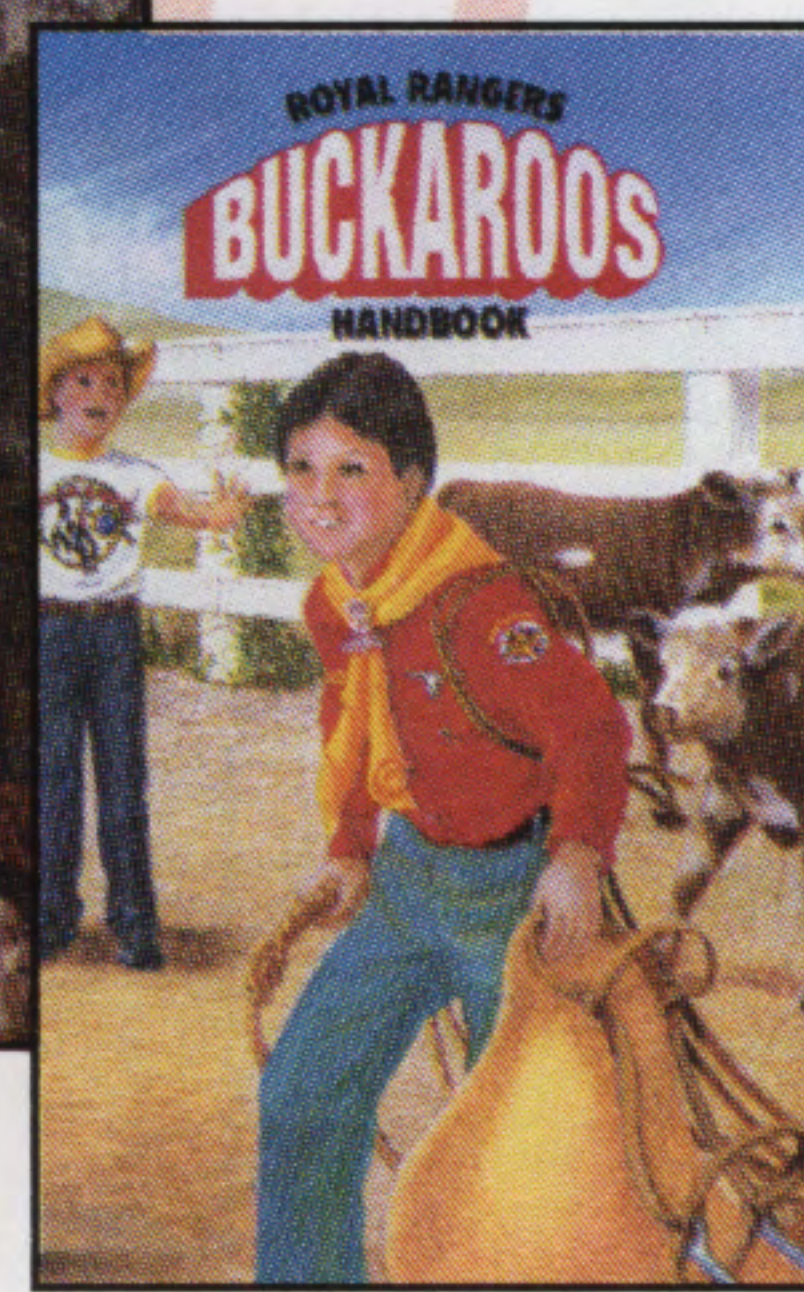
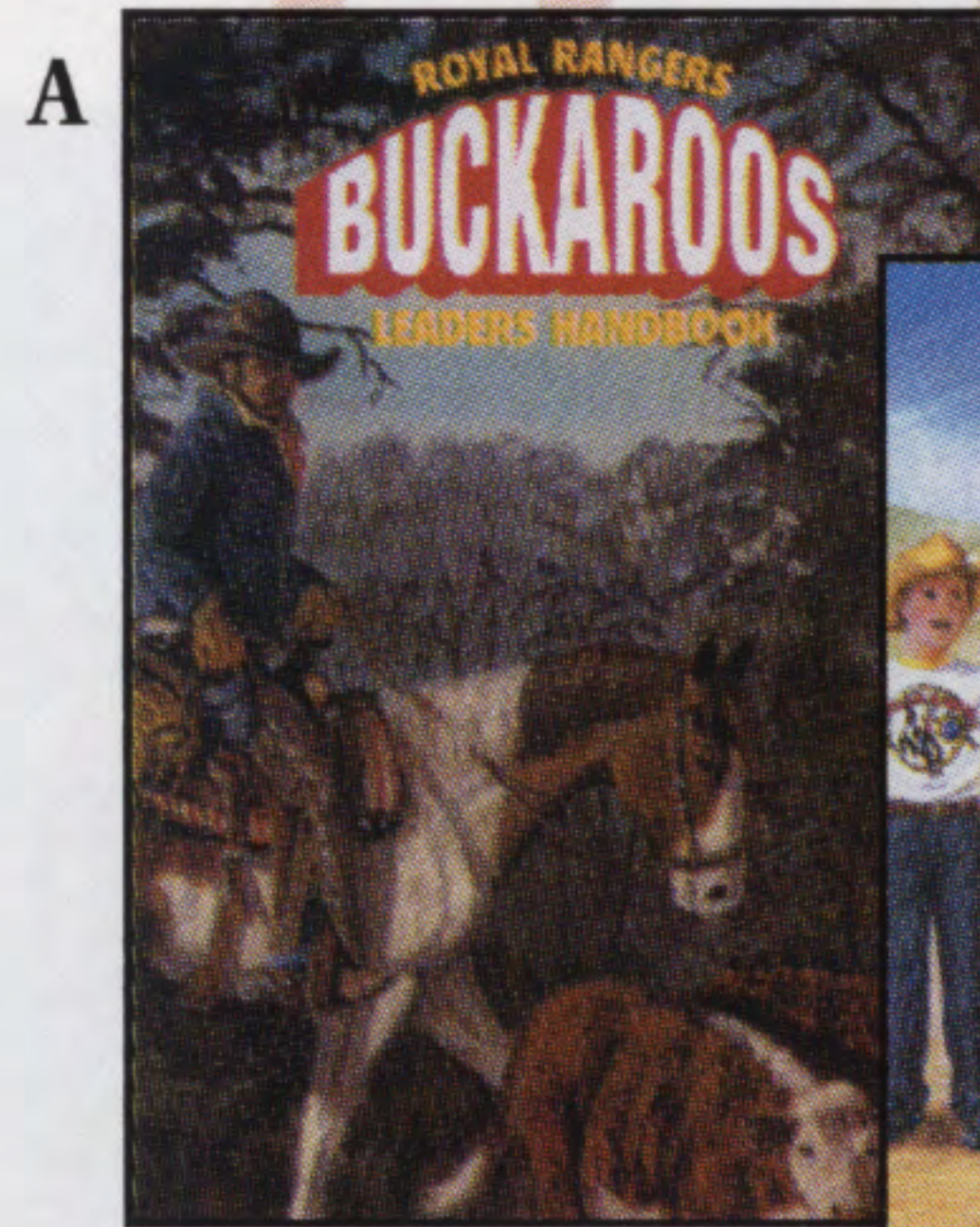

A. Pioneers Handbook. For grades 4-6. Has information on camping, hiking, first aid, games, nature study, crafts, physical fitness, Bible study, and service for Christ. Paper. 02MX1083 \$4.95

B. Pioneers Workbook, Second Edition. Designed to be used with *Pioneers Handbook*, 02MX1083, the workbook features the new Pioneers advancement trail. Assists boys in their achievements as it follows the advancement sequence and provides a method for passing each requirement. 02MX1093 \$3.95

C. Pioneers Advancement Chart. Includes space to track advancement and achievement awards of 18 Rangers. 20 x 26" 23MX8805 \$1.95

D. Pioneers Advancement Pins.

| | | |
|------------------------------|----------|--------|
| Powder Horn | 15MX6967 | \$1.75 |
| Bowie Knife | 15MX6944 | \$1.75 |
| Tomahawk | 15MX6945 | \$1.75 |
| Long Rifle | 15MX6949 | \$1.75 |
| Mountain Man. 5th level | 15MX0722 | \$3.95 |
| Silver Hawk Award. 6th level | 15MX0723 | \$7.95 |
| Gold Star Award. 6th level | 15MX0772 | \$1.25 |

E. Pioneers T-shirt. White 100% cotton T-shirt with red, black, and gray Pioneers emblem and Royal Rangers on center chest.

| | | |
|----------------|----------|---------|
| Boys M (10-12) | 08MX1422 | \$7.99 |
| Boys L (14-16) | 08MX1423 | \$7.99 |
| Adult S | 08MX1424 | \$8.99 |
| Adult M | 08MX1425 | \$8.99 |
| Adult L | 08MX1426 | \$8.99 |
| Adult XL | 08MX1427 | \$8.99 |
| Adult 2XL | 08MX1428 | \$9.99 |
| Adult 3XL | 08MX1429 | \$12.50 |
| Adult 4XL | 08MX1430 | \$16.50 |

F. Pioneers Low-profile Cap. Red brushed cotton cap. Embroidered red, black, and white Pioneers logo. Adjustable strap. 08MX1421 \$12.99

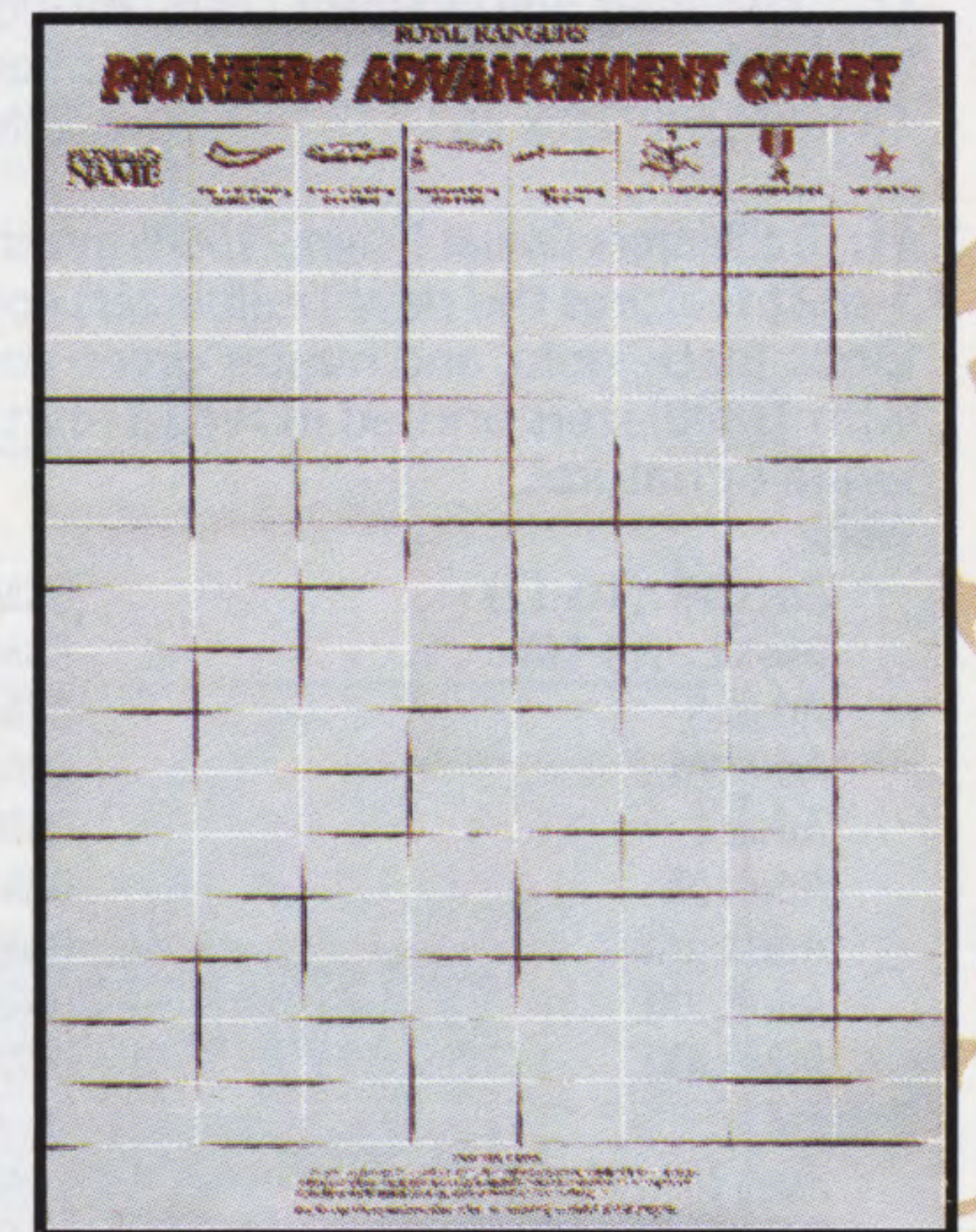
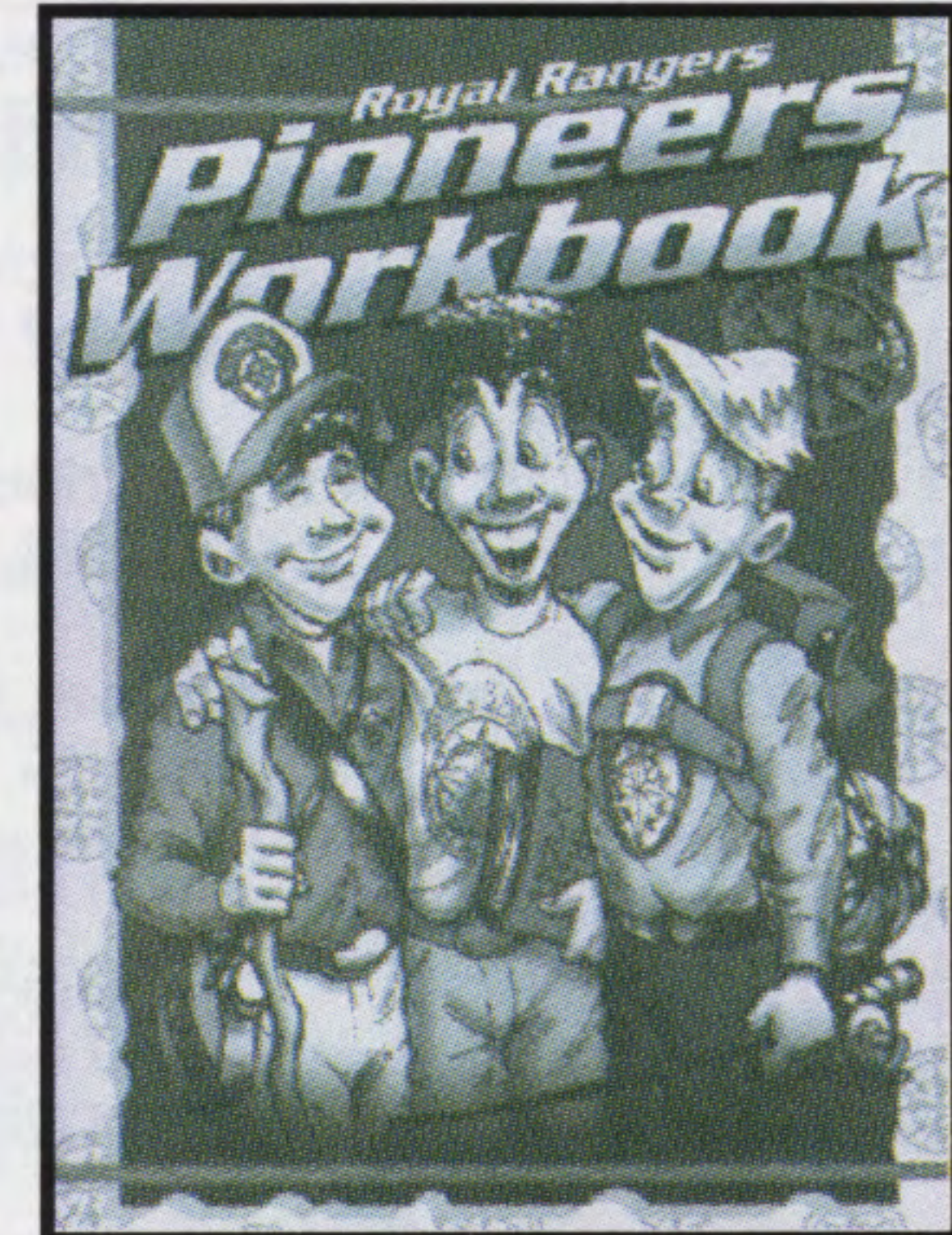
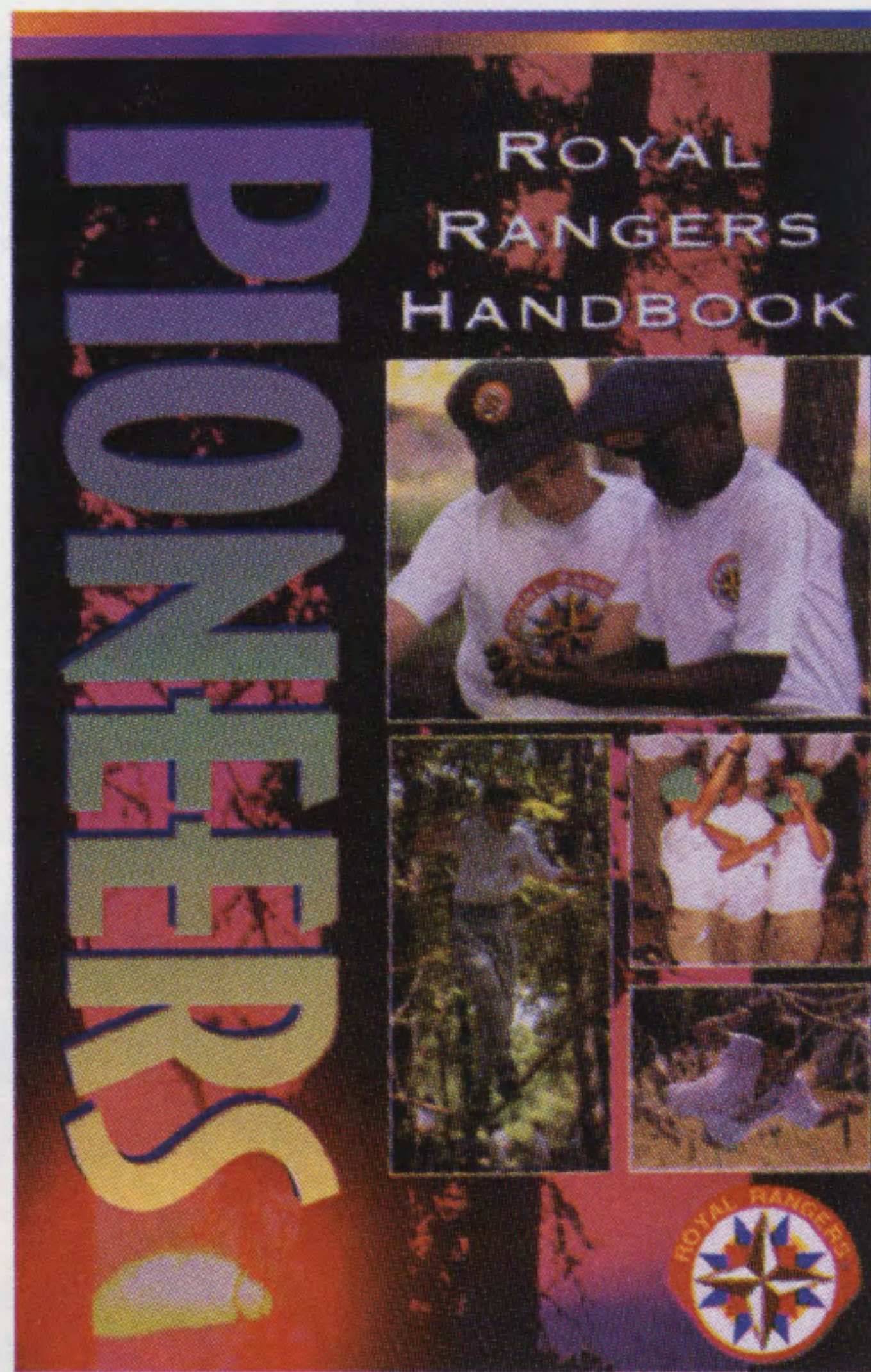

CHALLENGERS: Royal Rangers new program for boys ages 15-17. With 3 handbooks, Challengers can choose the option that's just right for them.

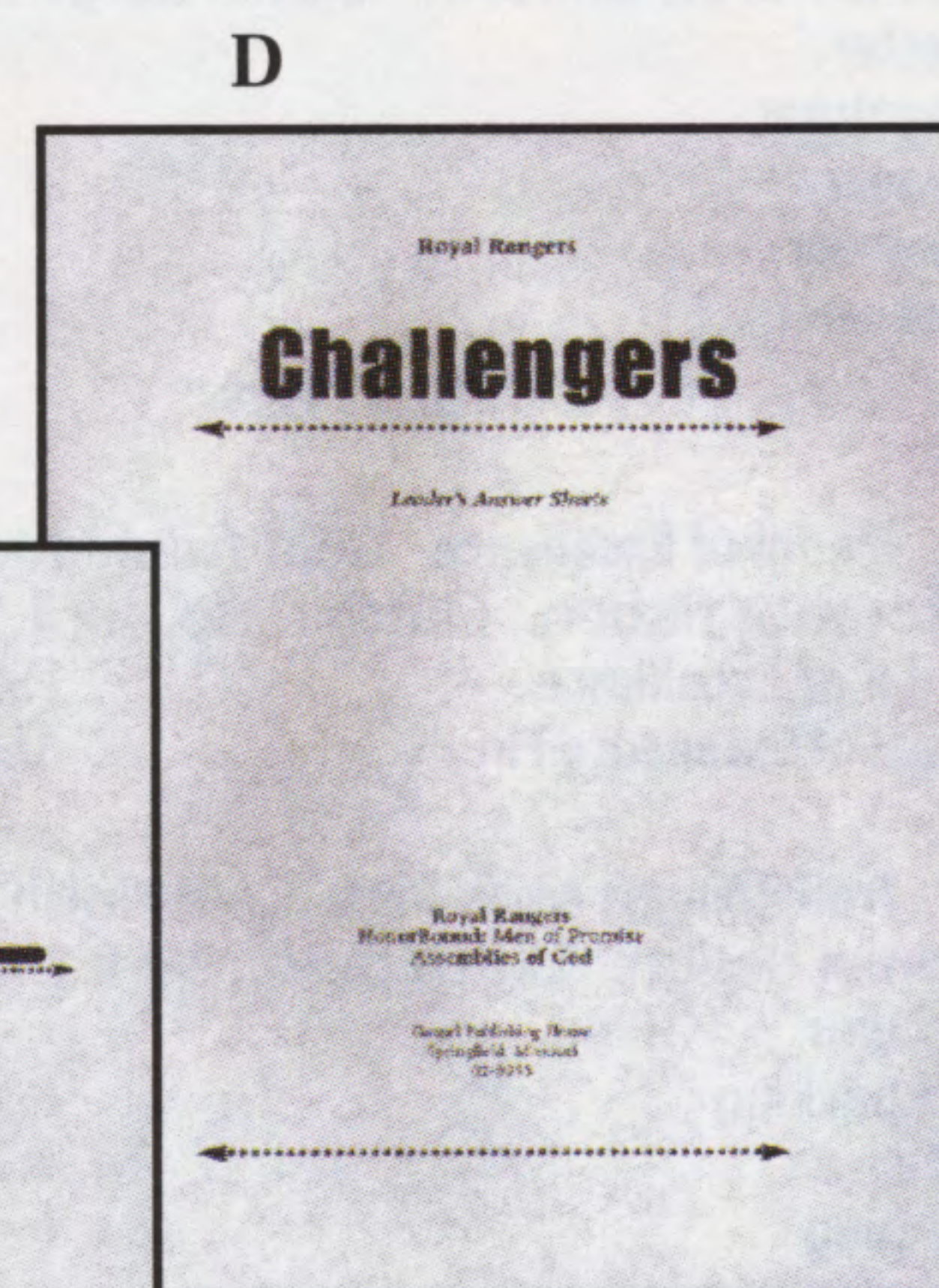
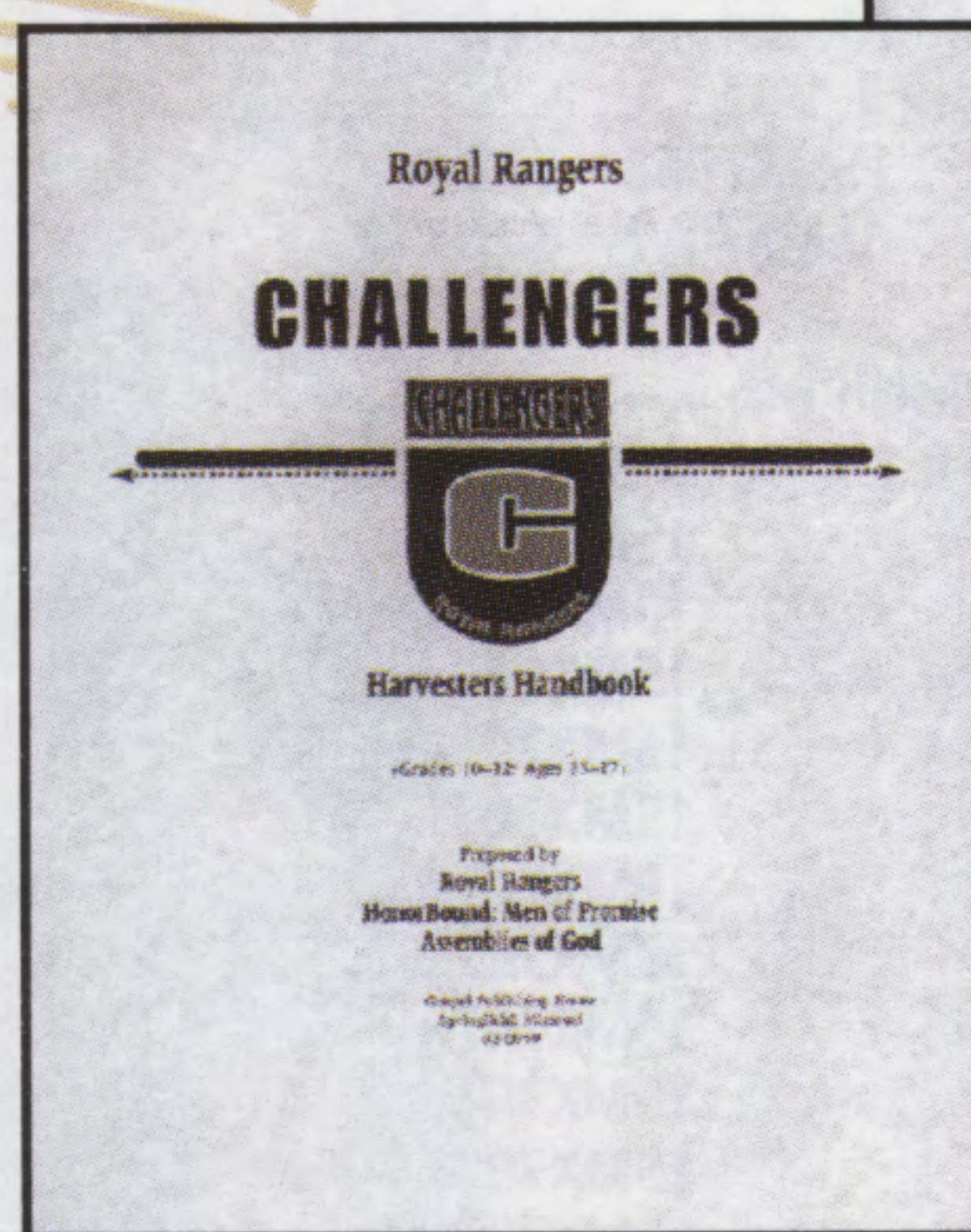
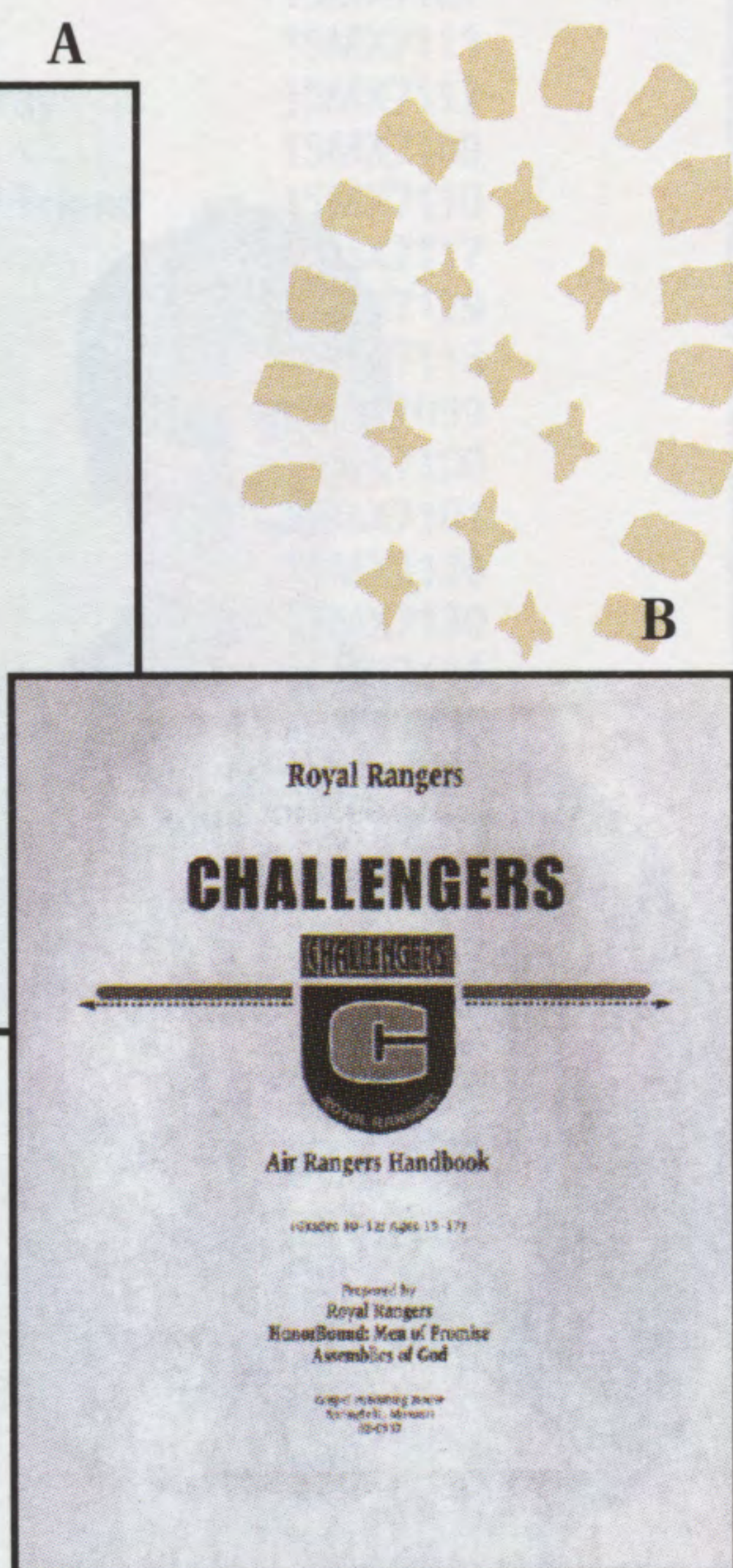

A. Royal Rangers Challengers: Trail Rangers Handbook. Presents the traditional Rangers program for teens. Includes *Core Kit* (08MX0475). Loose-leaf, 3-hole punched. 8 1/2 x 11" 02MX0951 \$16.99

B. Royal Rangers Challengers: Air Rangers Handbook. Expanded curriculum focuses on aviation. Loose-leaf, 3-hole punched. 8 1/2 x 11" 02MX0957 \$3.99

C. Royal Rangers Challengers: Harvesters Handbook. Emphasizes Christian growth, evangelism, and discipleship. Loose-leaf, 3-hole punched. 8 1/2 x 11" 02MX0959 \$3.99

D. The Bible and Today's Issues, Leader's Answers. Includes an overview of the Challengers program and answer guide to *The Bible and Today's Issues*, available with the *Royal Rangers Challengers Core Kit*. Loose-leaf, 3-hole punched. 8 1/2 x 11" 02MX0953 \$5.99

E. Royal Rangers Challengers Core Kit. Contains *Challengers: The Bible and Today's Issues*, *Royal Rangers Merit Packet*, and the *Challengers Binder with Tabs*. Core Kit included with *Trail Rangers Handbook* (02MX0951). 08MX0475 \$9.99

A. Challengers Name Tag. For uniform. Maroon embroidery on white twill. 4 x 1" 15MX7060 59¢

B. Challenger Advancement Pins (bars). Gold-finish bars for dress uniform. Clutch clasp. 3/8 x 1 1/4"

| | |
|------------|----------|
| Quester | 15MX7061 |
| Adventurer | 15MX7062 |
| Voyager | 15MX7063 |
| Navigator | 15MX7064 |
| Discoverer | 15MX7065 |

\$2.95 each

C. Medal of Excellence. Gold-finish. Medal includes decorative ribbon. Clutch clasp. 1 x 1 1/4"

| | | |
|-------------------------|----------|--------|
| Medal of Excellence | 15MX7066 | \$7.95 |
| Medal of Excellence Pin | 15MX7067 | \$2.75 |

D. Trail Rangers Merit Pins. Gold-finish pin with enamel design. Clutch clasp. 3/4 x 1"

| | |
|----------------------|----------|
| Bachelor | 15MX7068 |
| Backpacking | 15MX7124 |
| Bible | 15MX7069 |
| Camping | 15MX7070 |
| Christian Service | 15MX7071 |
| Citizenship | 15MX7072 |
| Cooking | 15MX7073 |
| CPR | 15MX7074 |
| First Aid | 15MX7075 |
| God and Church Award | 15MX7085 |
| Hiking | 15MX7076 |
| Hobby | 15MX7077 |
| Home Safety | 15MX7078 |
| Kayaking | 15MX7125 |
| Light-for-the-Lost | 15MX7079 |
| Nature | 15MX7080 |
| Physical Fitness | 15MX7081 |
| Safety | 15MX7082 |
| Tool Craft | 15MX7083 |
| Wilderness Survival | 15MX7084 |

\$2.99 each

E. Air Rangers Merit Pins. Gold-finish pin with enamel design. Clutch clasp. 3/4 x 1"

| | |
|-------------------------------|----------|
| Air Traffic Control | 15MX7086 |
| Aircraft Systems | 15MX7087 |
| Airplane Performance | 15MX7088 |
| Aviation Careers | 15MX7089 |
| Aviation History | 15MX7135 |
| Aviation Weather Fundamentals | 15MX7090 |
| Basic Aerodynamics | 15MX7091 |
| Federal Aviation Regulations | 15MX7137 |
| Flight Physiology | 15MX7136 |
| Flight Planning | 15MX7092 |
| Flight Preparation | 15MX7093 |
| Flight Proficiency | 15MX7094 |
| Introduction to Planes | 15MX7095 |
| Navigation | 15MX7096 |
| Solo Pilot | 15MX7097 |
| Weight and Balance | 15MX7126 |

\$2.99 each

Award Numerals. Gold medal numerals to be used for indicating number of medals of excellence earned.

| | |
|-----------|----------|
| Numeral 2 | 15MX0622 |
| Numeral 3 | 15MX0623 |

\$1.00 each

A



B

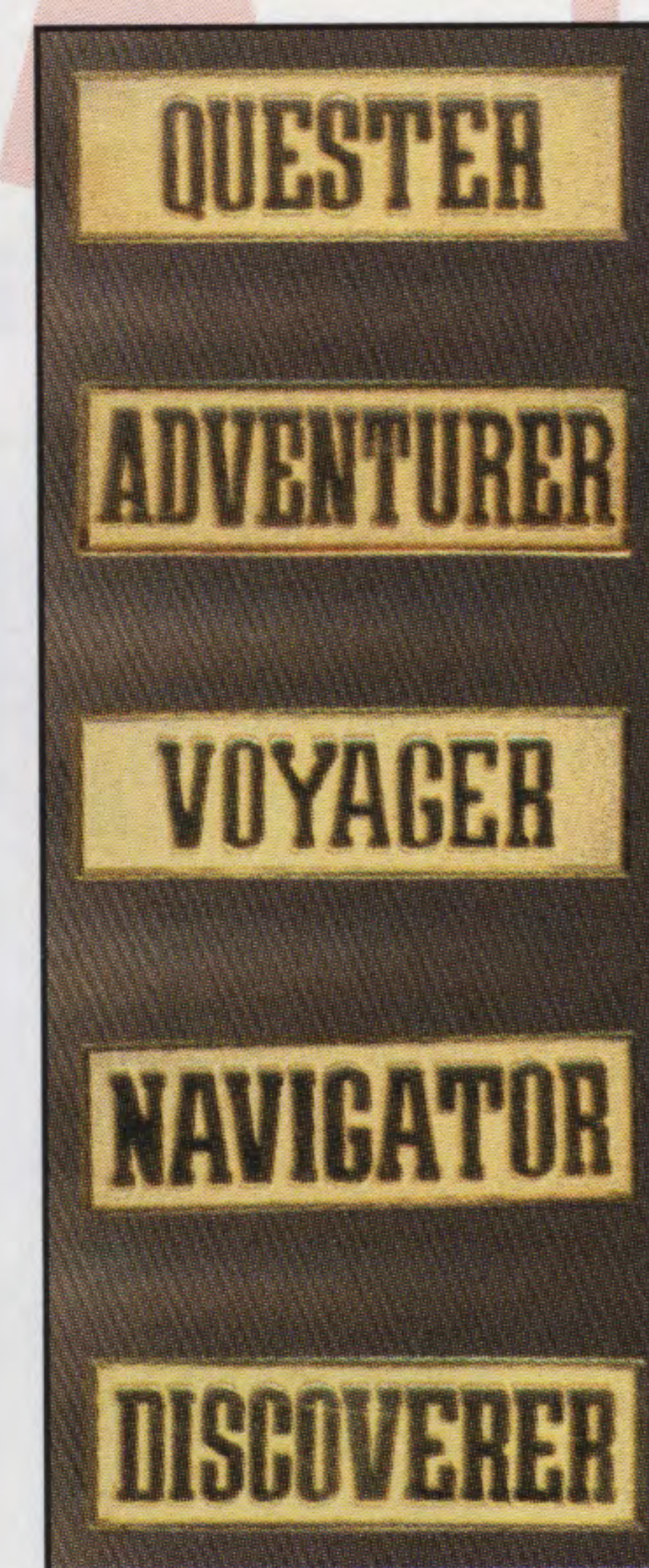

C



D

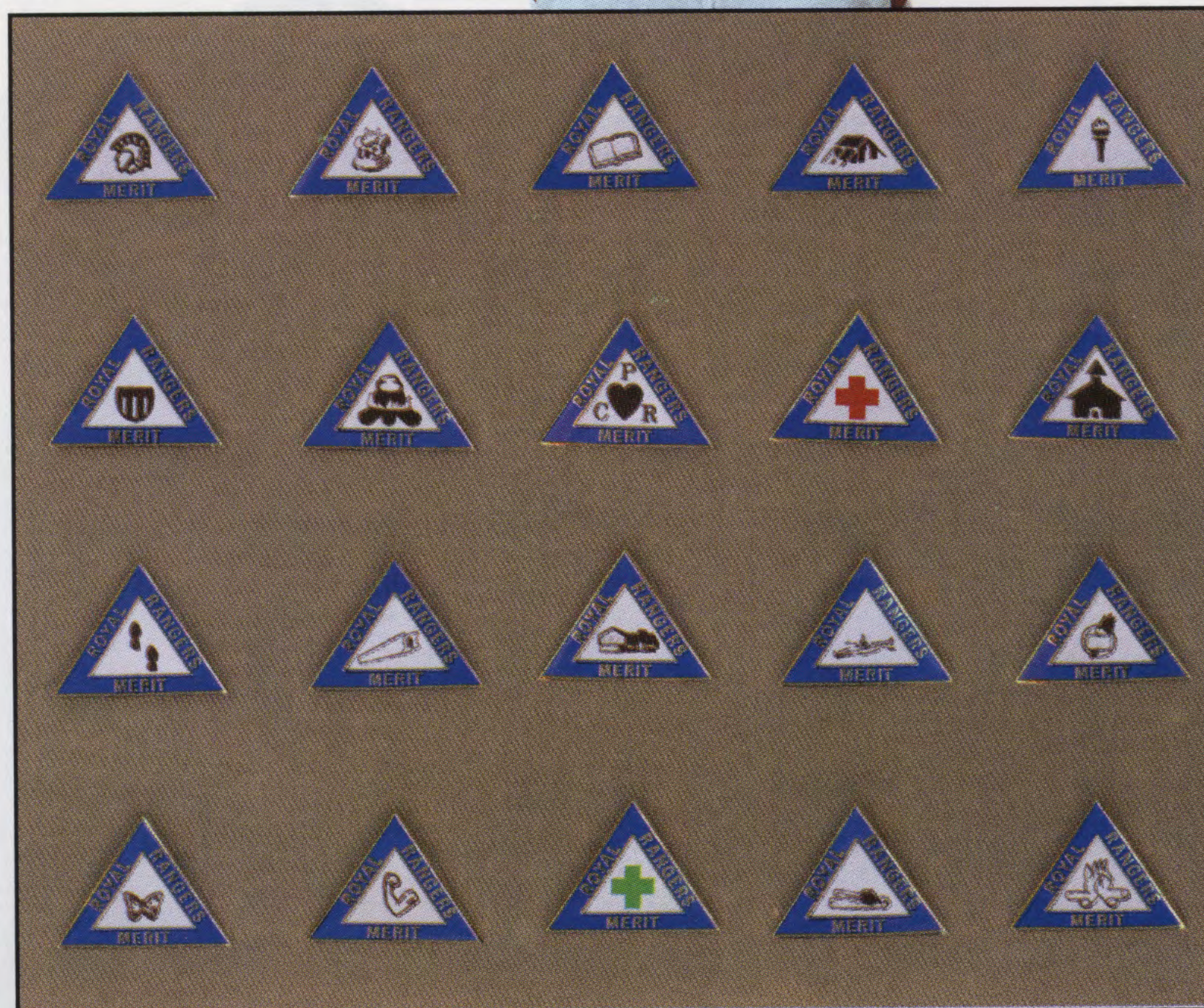

E

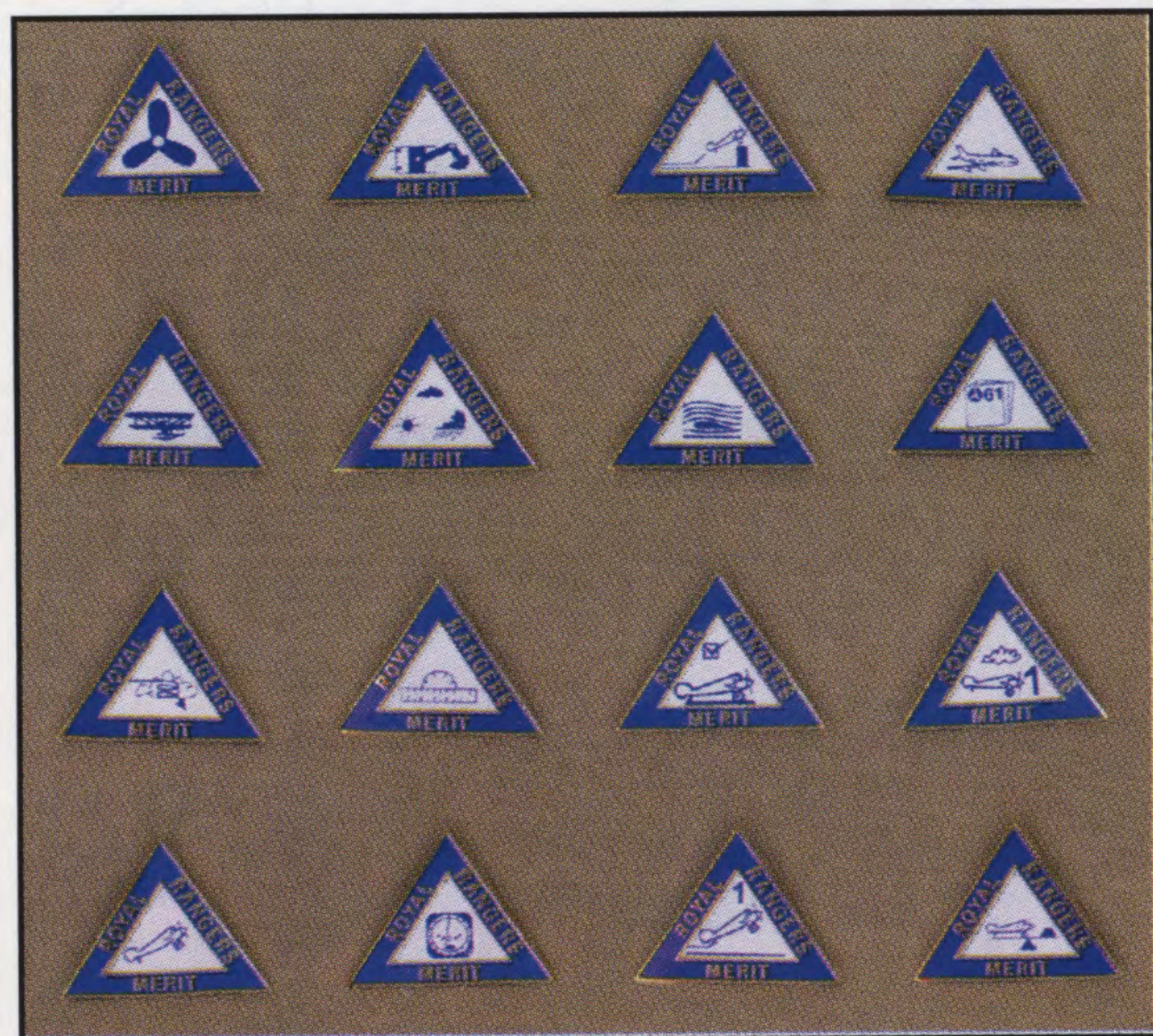

A. Harvesters Merit Pins. Gold-finish pin with enamel design. Clutch clasp. 3/4 x 1"

| | |
|--|----------|
| Ambassadors in Mission—Trip 1 | 15MX7113 |
| Ambassadors in Mission—Trip 2 | 15MX7114 |
| Ambassadors in Mission—Trip 3 | 15MX7115 |
| Bible | 15MX7128 |
| Bible Reading | 15MX7116 |
| Christian Growth: Christian Workers | 15MX7102 |
| Christian Growth: Christian Worship | 15MX7103 |
| Christian Growth: God's Design—Your Choice | 15MX7104 |
| Christian Growth: How to Study the Bible | 15MX7105 |
| Christian Growth: Personal Evangelism | 15MX7106 |
| Christian Growth: The Christian in His Community | 15MX7108 |
| Christian Growth: The Church | 15MX7107 |
| Christian Growth: We Believe | 15MX7111 |
| Christian Growth: When You Pray | 15MX7112 |
| Christian Growth: Your Bible | 15MX7109 |
| Christian Growth: Your Helpful Friend | 15MX7110 |
| Christian Missions | 15MX7117 |
| Christian Service | 15MX7129 |
| Church | 15MX7118 |
| Harvest Task Force—Trip 1 | 15MX7099 |
| Harvest Task Force—Trip 2 | 15MX7100 |
| Harvest Task Force—Trip 3 | 15MX7101 |
| Junior Chaplaincy | 15MX7120 |
| Light-for-the-Lost | 15MX7130 |
| Missions Abroad Placement Service—Trip 1 | 15MX7131 |
| Missions Abroad Placement Service—Trip 2 | 15MX7132 |
| Missions Abroad Placement Service—Trip 3 | 15MX7133 |
| Missions America Placement Service—Trip 1 | 15MX7121 |
| Missions America Placement Service—Trip 2 | 15MX7122 |
| Missions America Placement Service—Trip 3 | 15MX7123 |
| Senior Citizens | 15MX7134 |
| Statement of Faith | 15MX7098 |

\$2.99 each

A

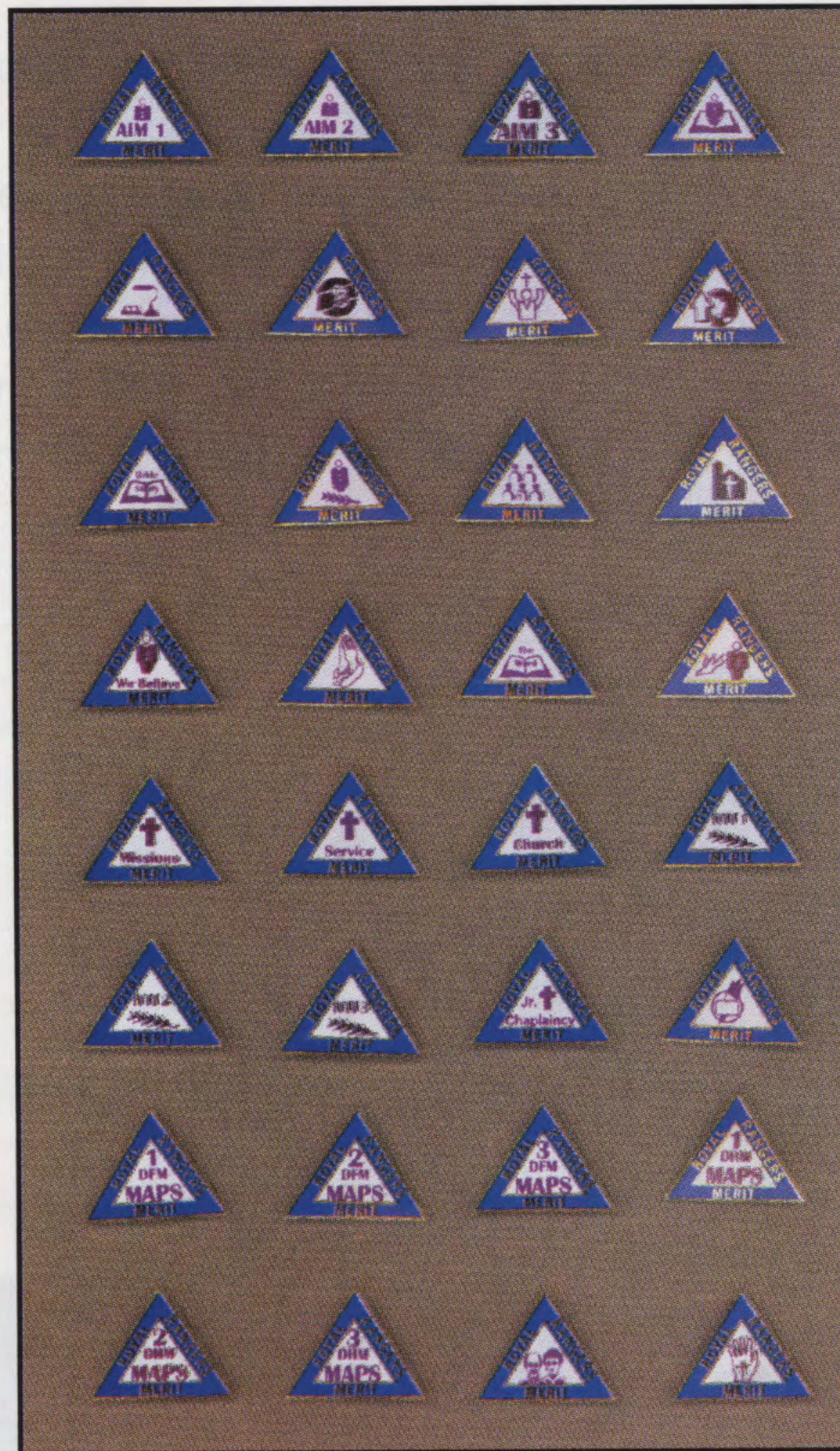

B. Challengers T-shirt. Multi-colored Challengers logo printed on 100% heavyweight cotton T-shirt.

| | | |
|-----------|----------|---------|
| Adult M | 08MX1442 | \$8.99 |
| Adult L | 08MX1443 | \$8.99 |
| Adult XL | 08MX1444 | \$8.99 |
| Adult 2XL | 08MX1445 | \$9.99 |
| Adult 3XL | 08MX1446 | \$12.50 |
| Adult 4XL | 08MX1447 | \$16.50 |

C. Challengers Low-profile Cap. Low-profile, black brushed cotton cap. Embroidered with gold, maroon, and red Challengers logo. Adjustable strap. 08MX1441 \$12.99

D. Challengers Jacket. Heavy fleece jacket of ash gray and maroon cotton-polyester blend is lined with 100% polyester. Ribbed collar and cuffs. Features a "letter jacket" style Challengers emblem embroidered on wool felt sewn to left chest.

| | | |
|----------|----------|---------|
| Adult M | 08MX1448 | \$49.95 |
| Adult L | 08MX1449 | \$49.95 |
| Adult XL | 08MX1450 | \$49.95 |



C



B

D

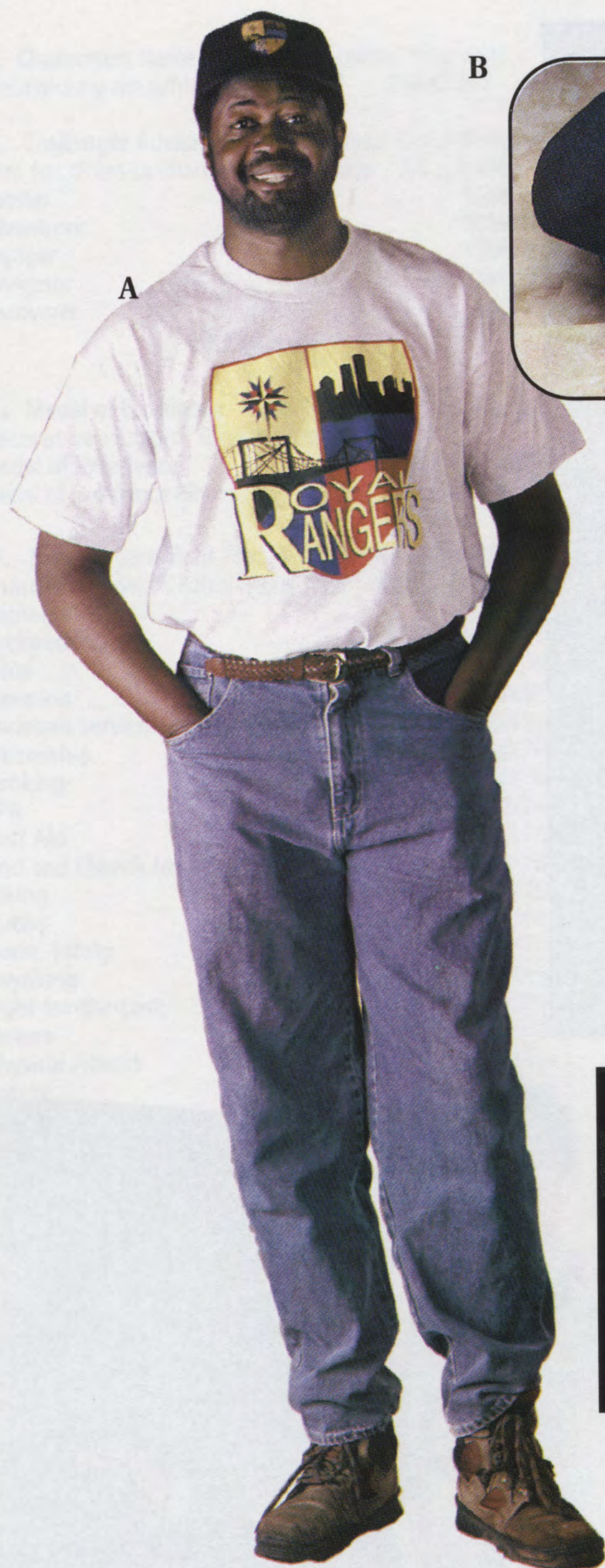

B



A

A. Urban Rangers T-shirt. Light gray T-shirt with brightly colored red, blue, yellow, and black shield featuring a skyline, bridge, logo, and the Royal Rangers name. 50% cotton and 50% polyester.

| | |
|-----------|----------|
| Adult S | 72MX9073 |
| Adult M | 72MX9074 |
| Adult L | 72MX9058 |
| Adult XL | 72MX9059 |
| Adult 2XL | 72MX9060 |

\$9.00 each; 7 or more, \$7.75 each

B. Urban Rangers Cap. Black cap featuring urban Rangers logo patch in color. Adjustable band.

| | |
|-------------|-------------|
| 72MX9067 | \$8.50 ea.; |
| 10 or more, | \$7.00 ea. |

C. Urban Rangers Videos. Educational videos for adults and children.

Harvest Task Force: Reaching Urban America. Promotes the National Urban Leadership Conference and focuses on Royal Rangers urban ministry. Approximately 4 min. 72MX9129 \$10.00

Urban Rangers—Dallas, Chicago. Promotes Royal Rangers involvement in the inner cities and encourages churches to raise funds for inner-city outposts. Approximately 8 min. 72MX9052 \$10.00

Breaking Powers Through Prayer. Briefly introduces some of Royal Rangers prayer and outreach strategies in progress across the nation. Focuses on leaders' gatherings, urban children's crusades, Bible distribution, and teen outreach. Approximately 4 min. 72MX9064 \$10.00

Incest: Solving the Pain. Addresses the tragic issue that affects one in 10 children. Includes interviews and counseling for the victims, perpetrators, and non-offending spouses. 46 min. 72MX9110 \$19.99

D. Urban Outpost Planning Guide. This 1-year urban outpost meeting manual contains meeting features, achievement badge activities, devotionals, and group activities.

| | | |
|------------------------|----------|---------|
| With Binder and Guides | 72MX9012 | \$13.45 |
| Without Binder | 72MX9013 | \$10.00 |
| Binder Only | 72MX9014 | \$3.50 |

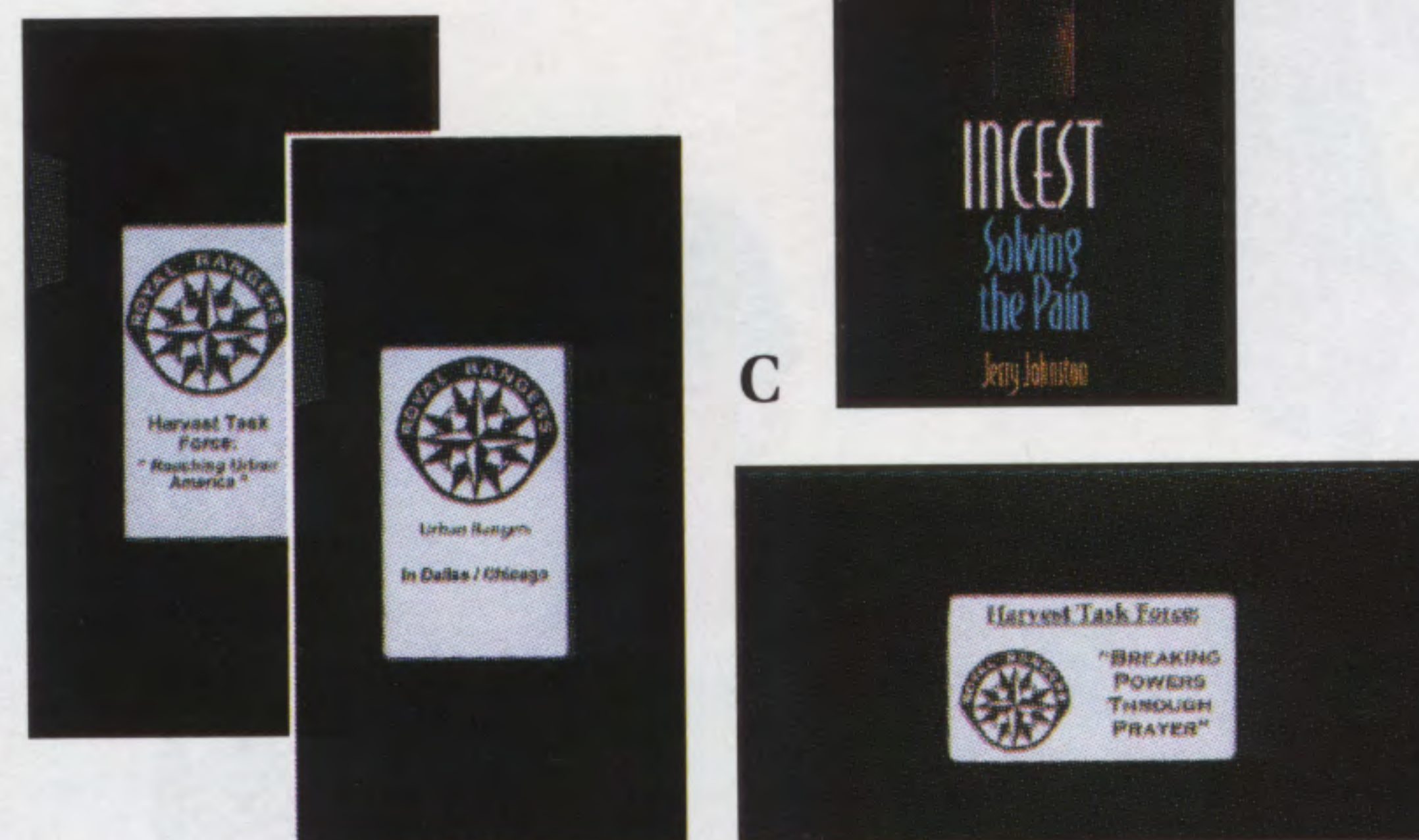

C

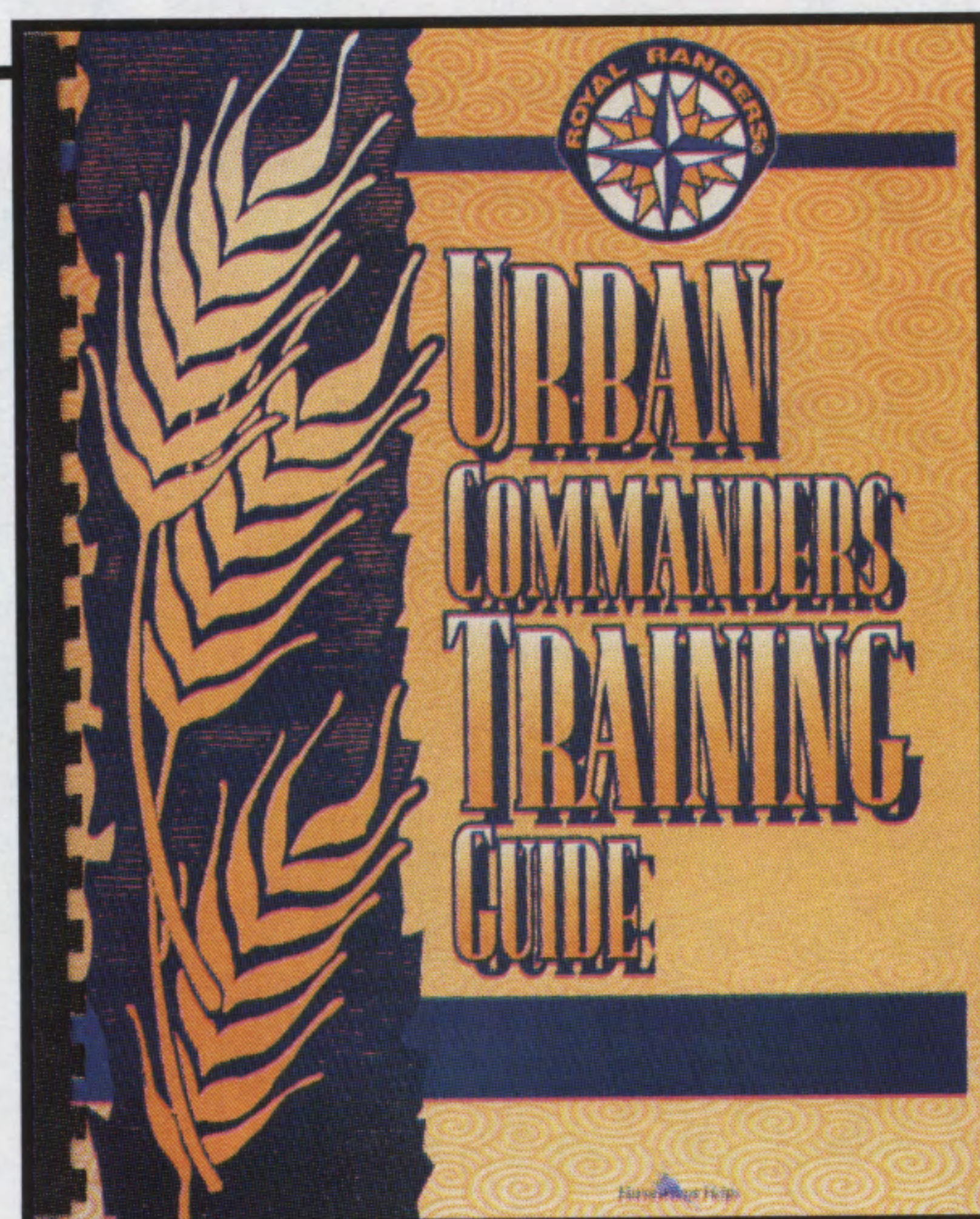

Urban Commanders Training Guide. Designed to teach Royal Rangers leaders to effectively use the Rangers ministry to reach inner-city youth. Takes an in-depth look at the realities of urban conditions, the importance of intercultural ministries, camping, how to apply the Royal Rangers program in a city setting, evangelism, motivation, counseling, gangs, raising funds, and other areas. Comb binding.

72MX9009 \$6.50

D

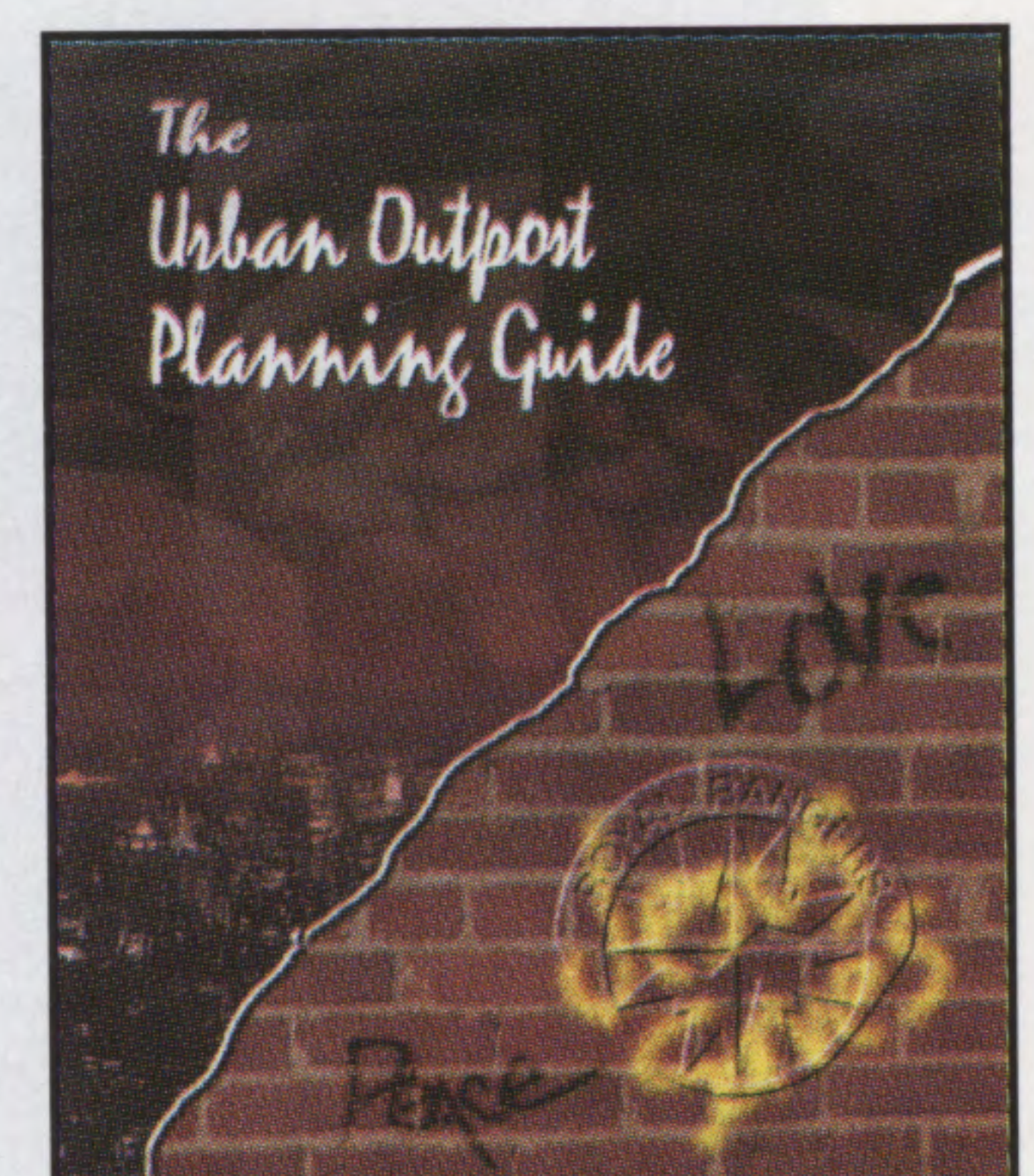

ROYAL RANGERS LEADER'S DRESS KHAKI UNIFORMS

Easy-care dress shirts made of a durable, lightweight 100% dacron polyester gabardine. Feature satin line collar and yoke, double-needle tailoring, Velcro™ closure pockets, and stitched military creases through pockets and flaps. Long sleeve shirt offers adjustable cuff, two-button closure, and banjo-shaped elbow reinforcement. Pants are 100% texturized woven dacron polyester gabardine—a soil-release fabric—with Comfort-in-Action waistband, quarter top pockets, triple-strength pocketing, tab closure on left rear pocket, double-thick interlined belt loops, French fly extension, self-locking brass zipper, and fashion-set permanent creases.



Leaders Dress Long Sleeve Shirt

| | |
|--------------|----------|
| 14 1/2 32-33 | 08MX5860 |
| 15 32-33 | 08MX5861 |
| 15 1/2 32-33 | 08MX5862 |
| 15 1/2 34-35 | 08MX5863 |
| 16 32-33 | 08MX5864 |
| 16 34-35 | 08MX5865 |
| 16 1/2 32-33 | 08MX5866 |
| 16 1/2 34-35 | 08MX5867 |
| 16 1/2 36-37 | 08MX5868 |
| 17 32-33 | 08MX5869 |
| 17 34-35 | 08MX5870 |
| 17 1/2 34-35 | 08MX5871 |
| 17 1/2 36-37 | 08MX5872 |

\$42.75 each

Leaders Dress Long Sleeve Shirt

| | |
|--------------|----------|
| 18 1/2 32-33 | 08MX5874 |
| 18 1/2 34-35 | 08MX5875 |
| 18 1/2 36-37 | 08MX5876 |
| 19 1/2 32-33 | 08MX5878 |
| 19 1/2 34-35 | 08MX5879 |
| 19 1/2 36-37 | 08MX5880 |

\$45.75 each

Dress Khaki Short Sleeve Shirt

| | |
|--------|----------|
| 15 1/2 | 08MX5881 |
| 16 | 08MX5882 |
| 16 1/2 | 08MX5883 |
| 17 | 08MX5884 |
| 17 1/2 | 08MX5885 |

\$39.50 each

Dress Khaki Short Sleeve Shirt

| | |
|--------|----------|
| 18 | 08MX5886 |
| 18 1/2 | 08MX5887 |
| 19 1/2 | 08MX5888 |

\$42.50 each

Dress Khaki Pants, Unfinished length

| | |
|----------------|----------|
| Waist size: 31 | 08MX5889 |
| Waist size: 32 | 08MX5890 |
| Waist size: 33 | 08MX5891 |
| Waist size: 34 | 08MX5892 |
| Waist size: 35 | 08MX5893 |
| Waist size: 36 | 08MX5894 |
| Waist size: 38 | 08MX5895 |
| Waist size: 40 | 08MX5896 |
| Waist size: 42 | 08MX5897 |

\$41.25 each

Dress Khaki Pants, Unfinished length

| | |
|----------------|----------|
| Waist size: 44 | 08MX5898 |
| Waist size: 46 | 08MX5899 |
| Waist size: 48 | 08MX5900 |
| Waist size: 50 | 08MX5901 |

\$44.25 each

Royal Rangers Belt. Khaki color with brass finish buckle. 1 1/4 x 1 3/4"

| | | |
|----------------|----------|--------|
| Adjusts to 42" | 08MX0214 | \$3.75 |
| Adjusts to 48" | 08MX0277 | \$4.25 |
| Adjusts to 60" | 08MX0332 | \$4.75 |



GENERAL KHAKI UNIFORM

Official Royal Rangers uniform is available in a wide range of sizes for men and boys, *with official full-color emblem embroidered on sleeve.* Fine quality, full cut, and tailored to fit. Fabric is permanent press 65% polyester dacron and 35% cotton with full shrinkage control. Needs no ironing.



| | |
|---------------------------|----------|
| Boy's Shirt—Long Sleeve. | |
| Size 8 (12 1/2 x 23 1/2) | 08MX0325 |
| Size 10 (13 x 25 1/2) | 08MX0326 |
| Size 12 (13 1/2 x 27 1/2) | 08MX0327 |
| Size 14 (14 x 29 1/2) | 08MX0328 |
| Size 16 (14 1/2 x 31 1/2) | 08MX0329 |

\$15.95 each

| | |
|-----------------------------------|----------|
| Men's Shirt—Long Sleeve. | |
| Size 14 (Collar 14 SL 32) | 08MX0330 |
| Size 14 (Collar 14 1/2 SL 33) | 08MX0331 |
| Size 15 (Collar 15 SL 32) | 08MX0334 |
| Size 15 (Collar 15 1/2 SL 33) | 08MX0335 |
| Size 15 (Collar 15 1/2 SL 34) | 08MX0336 |
| Size 16 (Collar 16 1/2 SL 32) | 08MX0340 |
| Size 16 (Collar 16 1/2 SL 33) | 08MX0341 |
| Size 16 (Collar 16 1/2 SL 34) | 08MX0342 |
| Size 17 (Collar 17 1/2 SL 33) | 08MX0346 |
| Size 17 1/2 (Collar 17 1/2 SL 35) | 08MX0347 |

\$16.95 each

| | |
|---------------------------|----------|
| Boy's Shirt—Short Sleeve. | |
| Size 8 | 08MX0554 |
| Size 10 | 08MX0555 |
| Size 12 | 08MX0556 |
| Size 14 | 08MX0557 |
| Size 16 | 08MX0558 |

\$15.50 each

| | |
|---------------------------|----------|
| Men's Shirt—Short Sleeve. | |
| Size 14 1/2 | 08MX0351 |
| Size 15 1/2 | 08MX0352 |
| Size 16 1/2 | 08MX0353 |
| Size 17 1/2 | 08MX0354 |

\$16.50 each

| | |
|-----------------------|----------|
| Boy's Pants. | |
| Size 8 (24W—21 1/2L) | 08MX0320 |
| Size 10 (25W—24L) | 08MX0321 |
| Size 12 (26W—26 1/2L) | 08MX0322 |
| Size 14 (27W—28 1/2L) | 08MX0323 |
| Size 16 (28W—29L) | 08MX0324 |

\$16.95 each

| | |
|-------------------|----------|
| Men's Pants. | |
| Size 29W—Unhemmed | 08MX0540 |
| Size 30W—Unhemmed | 08MX0541 |
| Size 31W—Unhemmed | 08MX0542 |
| Size 32W—Unhemmed | 08MX0543 |
| Size 33W—Unhemmed | 08MX0544 |
| Size 34W—Unhemmed | 08MX0545 |
| Size 36W—Unhemmed | 08MX0546 |
| Size 38W—Unhemmed | 08MX0547 |
| Size 40W—Unhemmed | 08MX0548 |
| Size 42W—Unhemmed | 08MX0549 |
| Size 44W—Unhemmed | 08MX0550 |
| Size 46W—Unhemmed | 08MX0551 |

\$17.95 each

| | |
|--|-----------------|
| Ties. | |
| Leaders. Navy blue, 4-in-hand. 3 1/2" | 08MX0208 \$6.95 |
| Leaders. Navy blue, redi-tie. Adult size. 16 1/2" | 08MX0219 \$4.95 |
| Pioneers. Red, redi-tie. Boys size. 12 1/2" | 08MX0215 \$5.95 |
| Trailblazers. Brown, redi-tie. Boys size. 14" | 08MX0216 \$5.95 |
| Trailblazers. Brown, redi-tie. Adult size. 16 1/2" | 08MX1324 \$5.95 |
| Trail Rangers. Maroon, 4-in-hand. 3 1/2" | 08MX1325 \$6.95 |
| Trail Rangers. Maroon, redi-tie. Adult size. 16 1/2" | 08MX0213 \$6.95 |

| | |
|---------------------|----------|
| Bolo Ties. | |
| Pioneers. Red | 08MX0155 |
| Trailblazers. Brown | 08MX0156 |
| Challengers. Maroon | 08MX0476 |
| Leaders. Navy blue | 08MX0159 |

\$4.35 each

A. Buckaroos Shirt. Fine quality red shirt made of 65% polyester and 35% cotton. Western-style cut. Adult sizes. (See page 4 for boys' sizes.)

| | |
|------------------------|----------|
| Size 14 1/2 Short 32" | 08MX0305 |
| Size 14 1/2 Medium 33" | 08MX0306 |
| Size 15 1/2 Short 32" | 08MX0307 |
| Size 15 1/2 Medium 34" | 08MX0308 |
| Size 15 1/2 Long 36" | 08MX0309 |
| Size 16 1/2 Short 33" | 08MX0310 |
| Size 16 1/2 Medium 34" | 08MX0311 |
| Size 16 1/2 Long 36" | 08MX0312 |
| Size 17 1/2 Medium 34" | 08MX0313 |
| Size 17 1/2 Long 36" | 08MX0314 |

\$15.95 each

B. Buckaroos Neckerchief. Yellow with the Royal Rangers emblem and the name "Buckaroos" printed on the back.

08MX0287 \$4.95

C. Buckaroos Neckerchief Slide. Durable, white plastic imprinted in red with Buckaroos Top Hand emblem.

08MX0288 \$1.25

D. Formal Blazer Outfit. Single-breasted, fully lined blazers feature sewn-on epaulets, gold and silver Royal Rangers emblem, full-cut fit, and silver tone buttons. Gray trousers have slant front pockets, 2 back pockets (one buttoned), 1 1/2" belt loops, hook closure, and a plain weave. Skirt is a modified A-line style and features single panel Shirred front, 2-panel back with kick pleat, side pockets, elastic back with zipper and button closure, and 2" hemmed bottom. All pieces are made of 100% VISA polyester. Blazers are non-refundable

Men's Navy Blazer.

Short 36-40; Reg. 36-50; Long 40-52; X-Long 42-50

Ladies' Navy Blazer. Sizes 6-20 08MX1068 \$120.00
08MX1069 \$120.00

Men's Slacks, Gray.

Waist sizes 29-46, unfinished hem. 08MX1070 \$45.00

Ladies' Skirt, Gray. Sizes 6-20. 08MX1071 \$45.00

E. Ladies' Cross-over Tie. Navy blue, button snap.

08MX1078 \$4.95

F. Royal Rangers Awards Vest. Blue stone-washed denim awards vest. 100% cotton.

| | | |
|----------|----------|--------|
| Youth S | 08MX0742 | \$7.95 |
| Youth M | 08MX0743 | \$7.95 |
| Youth L | 08MX0744 | \$7.95 |
| Adult S | 08MX0745 | \$9.95 |
| Adult M | 08MX0747 | \$9.95 |
| Adult L | 08MX0748 | \$9.95 |
| Adult XL | 08MX0751 | \$9.95 |

G. Royal Rangers Beret. Part of Pioneers, Trailblazers, and Trail Rangers uniform. Tailored of 100% wool. Royal blue with Royal Rangers emblem.

| | |
|------------------------|----------|
| Small (6 5/8-6 3/4) | 08MX0271 |
| Medium (6 7/8-7) | 08MX0272 |
| Large (7 1/8-7 1/4) | 08MX0273 |
| X-Large 7 3/8-7 1/2) | 08MX0252 |
| 2X-Large (7 5/8-7 3/4) | 08MX0250 |

\$10.50 each

H. Royal Rangers Cap. Navy blue brushed cotton cap with Royal Rangers emblem. Adjustable, one size fits all.

08MX0254 \$7.95

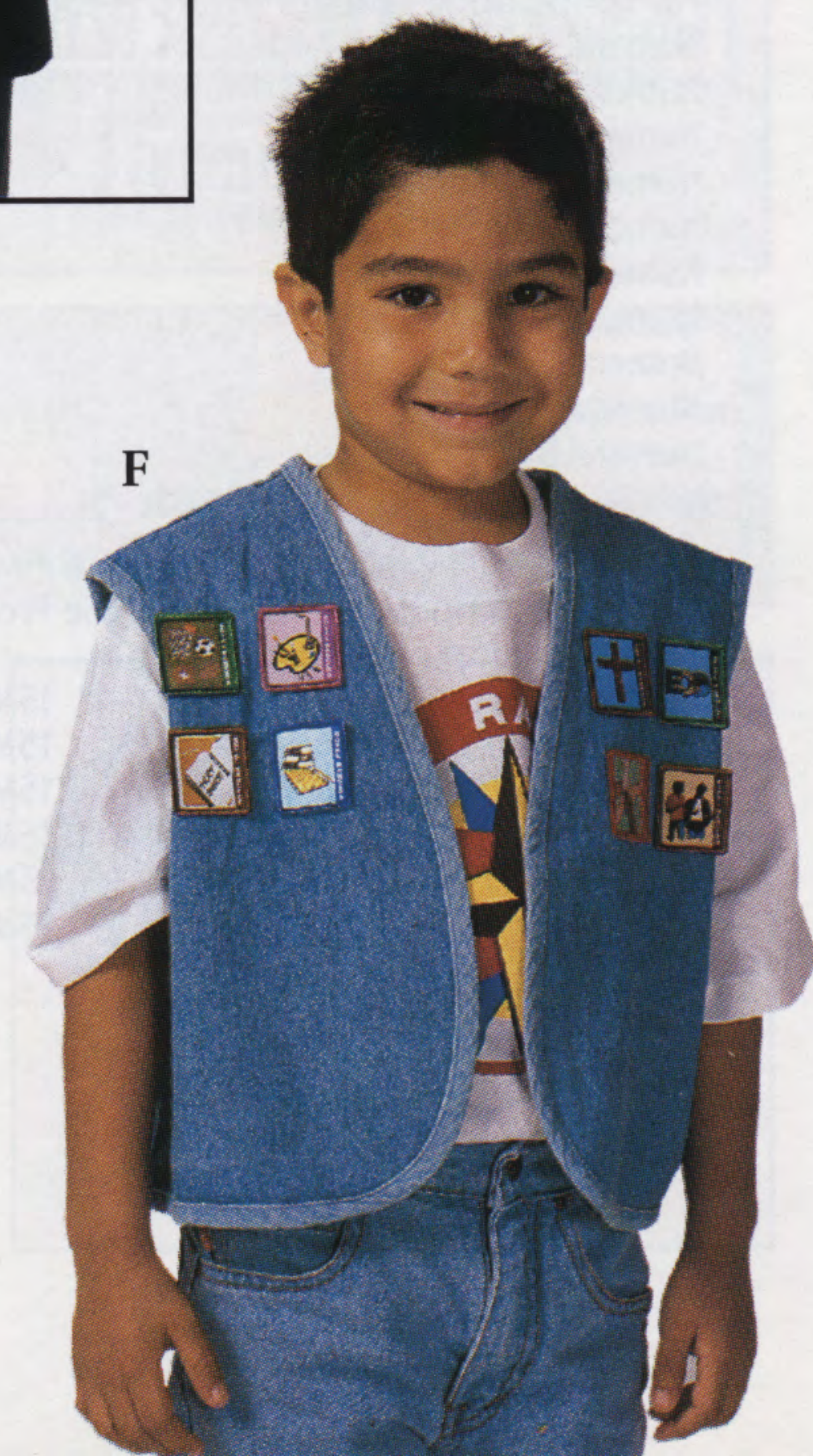
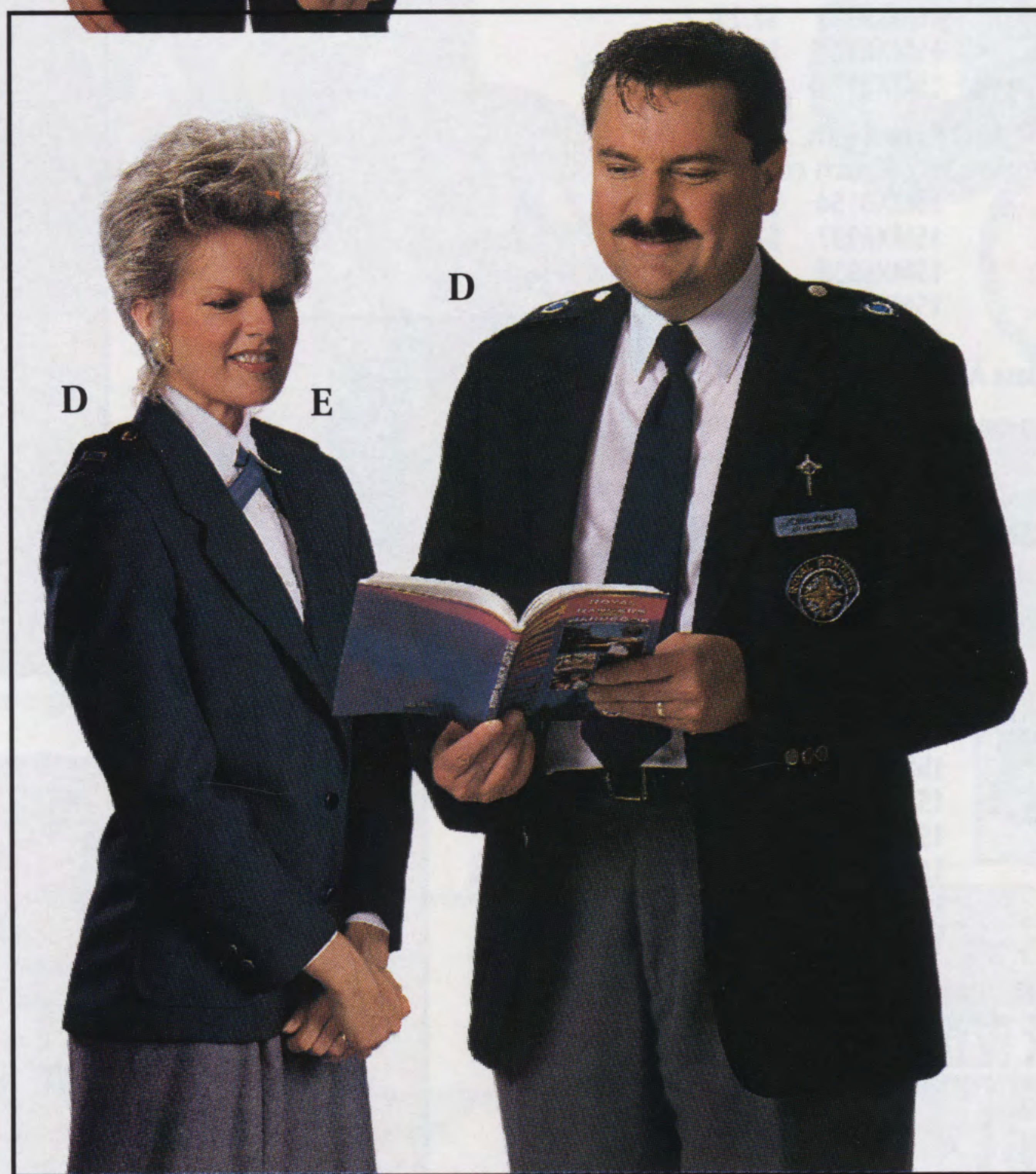
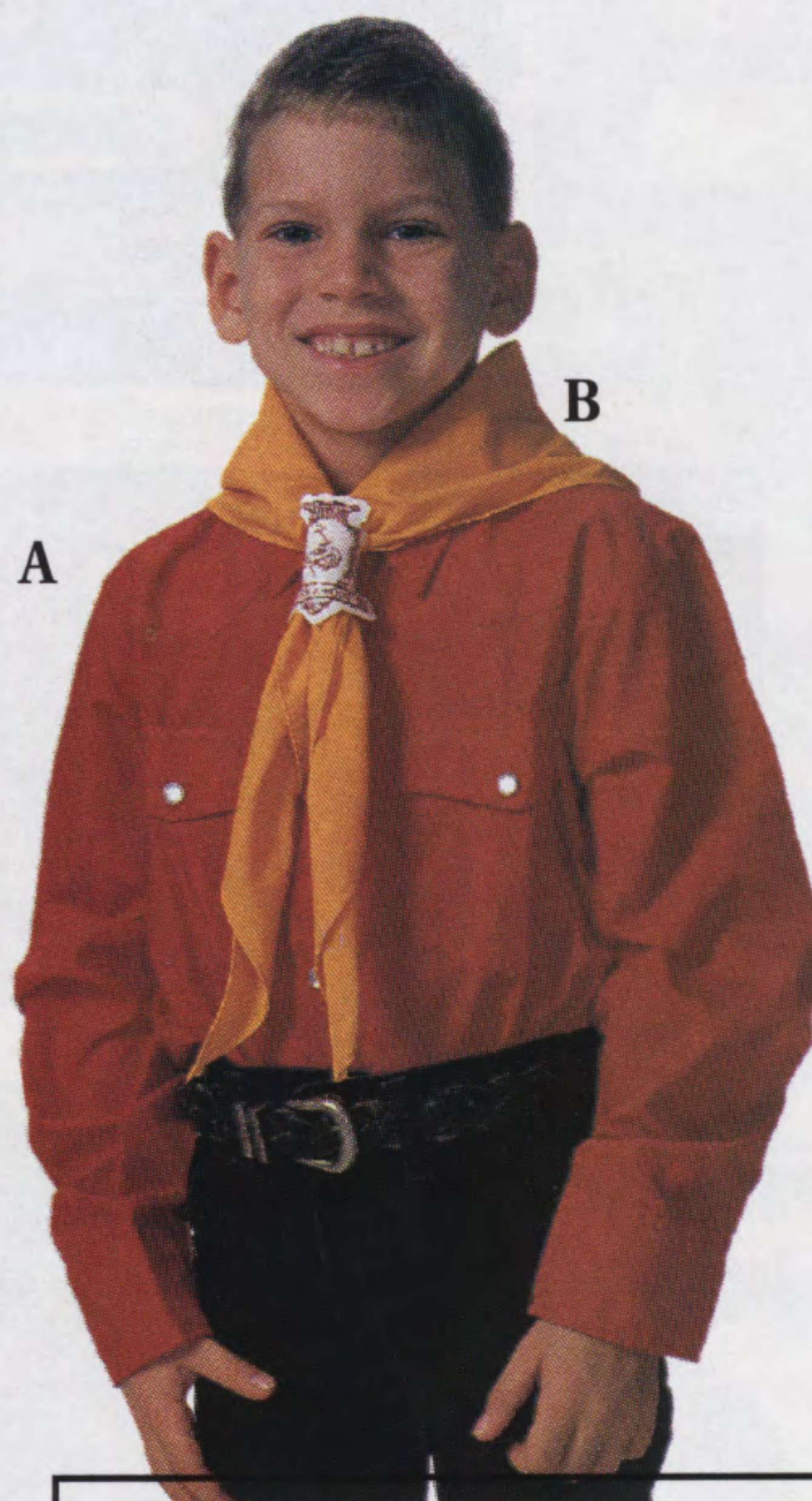

A. Class B Ribbon Mounting Bars.

| | | |
|--------|----------|-----|
| Single | 15MX0197 | 69¢ |
| Double | 15MX0198 | 79¢ |
| Triple | 15MX0199 | 89¢ |

B. Class B Awards. To be worn by leaders only in lieu of ribbon medal awards on Class B uniforms only.

| | | |
|---|----------|--------|
| 1. Outpost Commander | 15MX0607 | \$1.95 |
| 2. Leaders Service | 15MX0608 | \$1.95 |
| 3. Gold Medal of Achievement | 15MX0609 | \$2.95 |
| 4. Outstanding Service | 15MX0630 | \$1.95 |
| 5. Missions Project Award | 15MX0734 | \$1.95 |
| 6. Buckaroos-Straight Arrows Medal of Achievement | 15MX0631 | \$1.95 |
| 7. Junior Leaders Service Award | 15MX0632 | \$1.95 |
| 8. Medal of Valor | 15MX0633 | \$2.95 |
| 9. Medal of Merit | 15MX0634 | \$2.95 |
| 10. Leader's Medal of Achievement | 15MX0635 | \$1.95 |
| 11. Silver Eagle | 15MX0636 | \$1.95 |
| 12. Silver Cluster | 15MX0637 | \$1.95 |
| 13. Gold Cluster | 15MX0638 | \$1.95 |
| 14. Blue Cluster | 15MX0639 | \$1.95 |
| 15. Medal of Courage | 15MX0795 | \$2.95 |

C. Royal Rangers LTC Unit Award Pins. To be awarded upon successful completion of each course.

| | | |
|---|----------|--------|
| LTC Unit | 15MX0155 | \$3.50 |
| Organization | 15MX6931 | \$2.25 |
| Counselor | 15MX6932 | \$2.25 |
| Coordinator | 15MX6933 | \$2.25 |
| Camping | 15MX6934 | \$2.25 |
| Leader's Medal of Achievement (Class A) | 15MX0170 | \$7.50 |

D. Buckaroos-Straight Arrows LTC Unit Award Pins.

Awarded upon successful completion of each course.

| | | |
|---|----------|--------|
| LTC Unit | 15MX0154 | \$3.50 |
| Organization | 15MX6937 | \$2.25 |
| Counselor | 15MX6938 | \$2.25 |
| Coordinator | 15MX6939 | \$2.25 |
| Camping | 15MX6940 | \$2.25 |
| Leader's Medal of Achievement (Class A) | 15MX0172 | \$7.50 |

E. Class A Awards. To be worn on Class A uniforms only.

| | | |
|--|----------|---------|
| 1. Pathfinder Medal | 15MX0152 | \$4.95 |
| 2. Missions Project Medal | 15MX0151 | \$7.50 |
| 3. Outpost Commander | 15MX6954 | \$7.50 |
| 4. Leaders Service | 15MX0491 | \$7.50 |
| 5. Outstanding Service | 15MX0492 | \$7.50 |
| 6. Junior Leaders Service | 15MX0539 | \$7.50 |
| 7. Leader's Medal of Achievement | 15MX0170 | \$7.50 |
| 8. Buckaroos-Straight Arrows Leader's Medal of Achievement | 15MX0172 | \$7.50 |
| Medal of Merit | 15MX0163 | \$9.50 |
| Gold Cluster | 15MX0162 | \$9.50 |
| Silver Cluster | 15MX0487 | \$9.50 |
| Blue Cluster | 15MX0493 | \$9.50 |
| Medal of Courage | 15MX0794 | \$10.50 |

F. Award Numerals. Gold medal numerals to be used for consecutive years of award recognition.

| | |
|-----------|----------|
| Numeral 0 | 15MX0620 |
| Numeral 1 | 15MX0621 |
| Numeral 2 | 15MX0622 |
| Numeral 3 | 15MX0623 |
| Numeral 4 | 15MX0624 |
| Numeral 5 | 15MX0625 |
| Numeral 6 | 15MX0626 |
| Numeral 7 | 15MX0627 |
| Numeral 8 | 15MX0628 |
| Numeral 9 | 15MX0629 |

\$1.00 each

G. Frontier Camping Fellowship Award Pins. Use to recognize accomplishments within the Frontier Camping Fellowship. Clutch pin clasp.

| | | |
|-----------------------------------|----------|--------|
| FCF Frontiersman Pin (1st level) | 15MX6943 | \$2.50 |
| FCF Buckskin Pin (2nd level) | 15MX0277 | \$6.50 |
| FCF Wilderness Pin (3rd level) | 15MX0278 | \$6.50 |
| FCF Company Trapper (1st level) | 15MX0517 | \$5.50 |
| FCF Bourgeois Trapper (2nd level) | 15MX0518 | \$5.50 |
| FCF Free Trapper (3rd level) | 15MX0519 | \$5.50 |

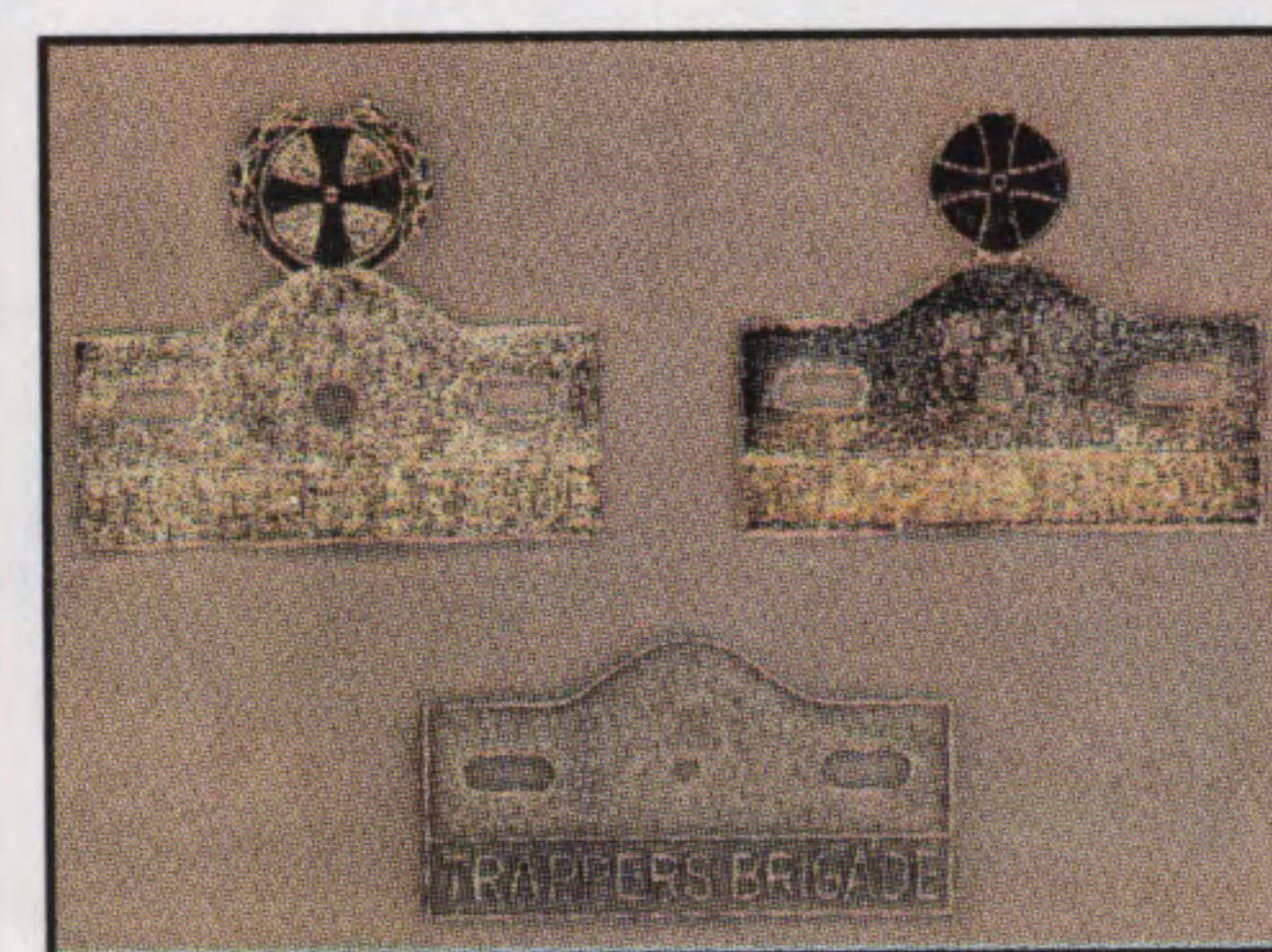
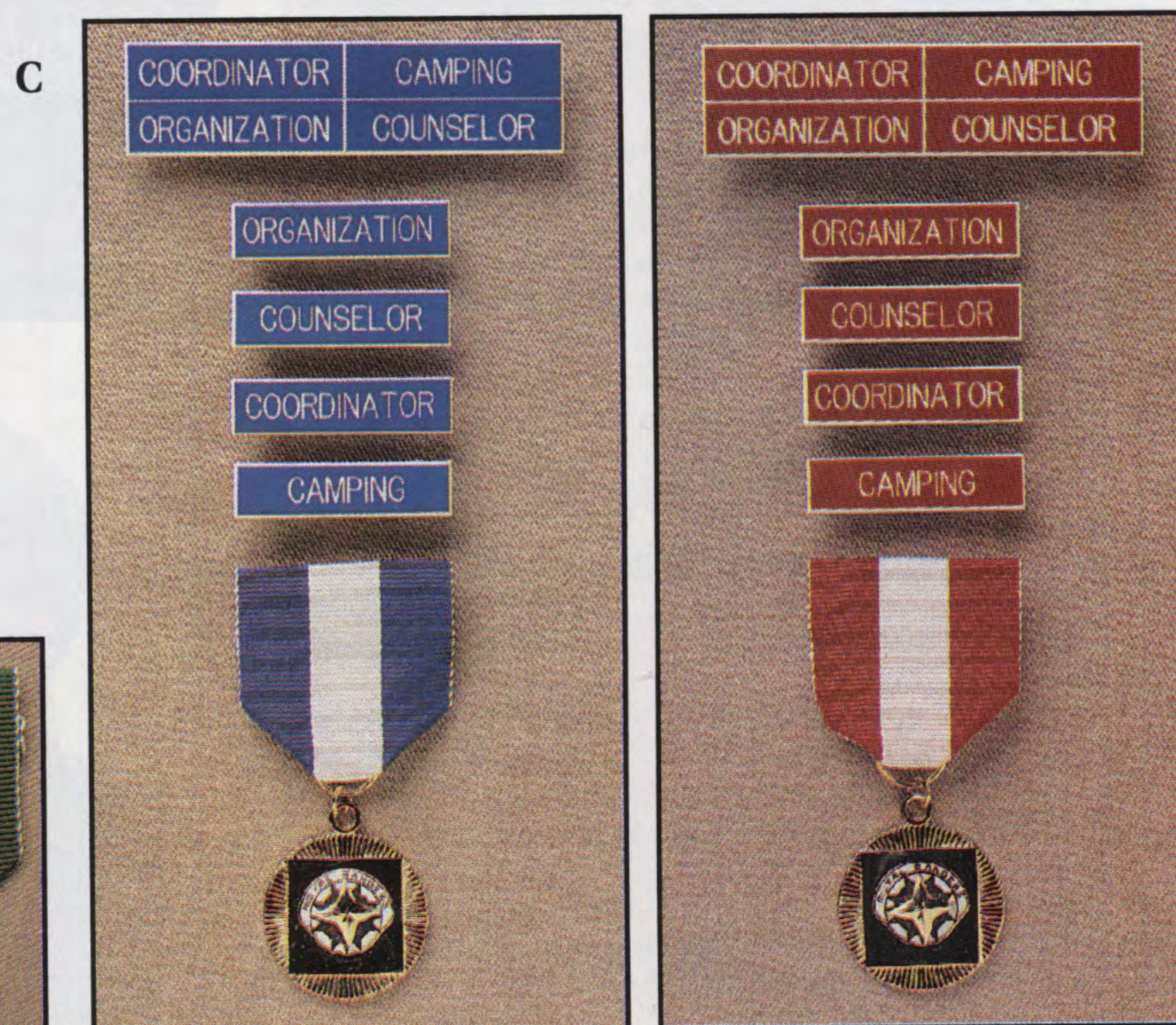
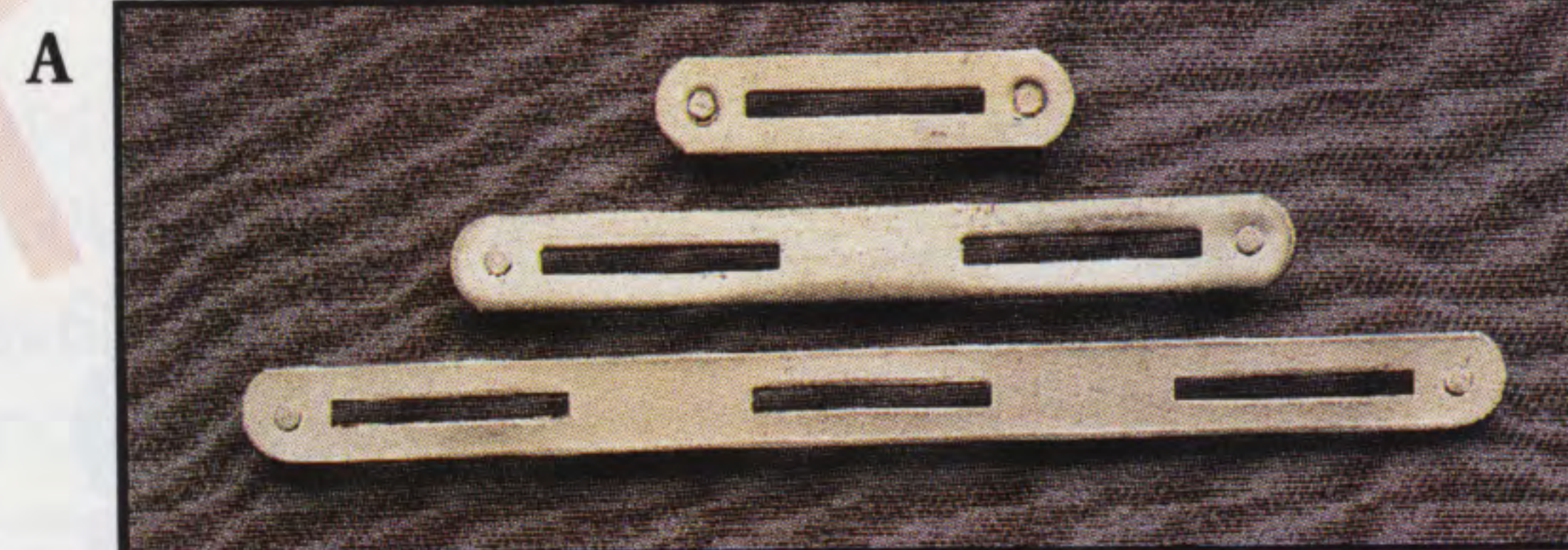

A. Collar Ornaments. Priced and sold in pairs.

| | | |
|---|----------|--------|
| Commander Bars (2 bars, Royal Blue) | | |
| For Dress Blazer | 15MX6952 | \$4.95 |
| Miniature for Collar | 15MX0380 | \$4.95 |
| Lieutenant Commander Bar (1 bar, Royal Blue) | | |
| For Dress Blazer | 15MX6951 | \$4.95 |
| Miniature for Collar | 15MX0381 | \$4.95 |
| Senior Commander Bars (2 bars, White) | | |
| For Dress Blazer | 15MX6948 | \$4.95 |
| Miniature for Collar | 15MX0382 | \$4.95 |
| Junior Commander Bar (1 bar, Red) | | |
| For Dress Blazer | 15MX6947 | \$4.95 |
| Miniature for Collar | 15MX0383 | \$4.95 |
| Outpost Councilman Bars (2 bars, Gold) | | |
| For Dress Blazer | 15MX6930 | \$4.95 |
| Miniature for Collar | 15MX0384 | \$4.95 |
| National Officers (Gold Star) | | |
| For Dress Blazer | 15MX0180 | \$3.75 |
| Miniature for Collar | 15MX0385 | \$1.75 |
| District Commander (Eagle) | | |
| For Dress Blazer | 15MX0181 | \$3.75 |
| Miniature for Collar | 15MX0386 | \$1.75 |
| Deputy District Commander (Silver Oak Leaf) | | |
| For Dress Blazer | 15MX0182 | \$3.75 |
| Miniature for Collar | 15MX0387 | \$1.75 |
| Sectional Commander (Gold Oak Leaf) | | |
| For Dress Blazer | 15MX0183 | \$3.75 |
| Miniature for Collar | 15MX0388 | \$1.75 |
| Area Commander (Blue Oak Leaf) | | |
| For Dress Blazer | 15MX0179 | \$3.75 |
| Miniature for Collar | 15MX0389 | \$1.75 |

B. Chaplain's Cross. 1 1/4 x 1" 15MX0171 \$5.95

C. Outpost Numerals.

| | |
|-----------|----------|
| Numeral 0 | 15MX0184 |
| Numeral 1 | 15MX0185 |
| Numeral 2 | 15MX0186 |
| Numeral 3 | 15MX0187 |
| Numeral 4 | 15MX0188 |
| Numeral 5 | 15MX0189 |
| Numeral 6 | 15MX0190 |
| Numeral 7 | 15MX0191 |
| Numeral 8 | 15MX0192 |
| Numeral 9 | 15MX0193 |

59¢ each

D. Miniature Outpost Numerals for Buckaroos and Straight Arrows Uniforms.

| | |
|---------------------|----------|
| Miniature Numeral 0 | 15MX0594 |
| Miniature Numeral 1 | 15MX0595 |
| Miniature Numeral 2 | 15MX0596 |
| Miniature Numeral 3 | 15MX0597 |
| Miniature Numeral 4 | 15MX0598 |
| Miniature Numeral 5 | 15MX0599 |
| Miniature Numeral 6 | 15MX0600 |
| Miniature Numeral 7 | 15MX0601 |
| Miniature Numeral 8 | 15MX0602 |
| Miniature Numeral 9 | 15MX0603 |

50¢ each

E. Royal Rangers Outpost Patrol Patches. Colorful identifying patches in a variety of designs. See chapter 2 of the *Royal Rangers Leaders Manual (02MX1037)*, for information on patrol systems. 2" dia.

| | |
|----------|----------|
| Antelope | 15MX0780 |
| Bear | 15MX0781 |
| Beaver | 15MX0782 |
| Bobcat | 15MX0783 |
| Buffalo | 15MX0784 |
| Cougar | 15MX0785 |
| Eagle | 15MX0786 |
| Elk | 15MX0787 |
| Fox | 15MX0788 |
| Gator | 15MX0789 |
| Hawk | 15MX0790 |
| Owl | 15MX0791 |
| Wolf | 15MX0792 |

\$1.50 each

F. Straight Arrows Insignia. Gold arrow embroidered on a red background. Wear beneath small Royal Rangers emblem on right side of vest. 3/4 x 3 1/4" 15MX0403 75¢

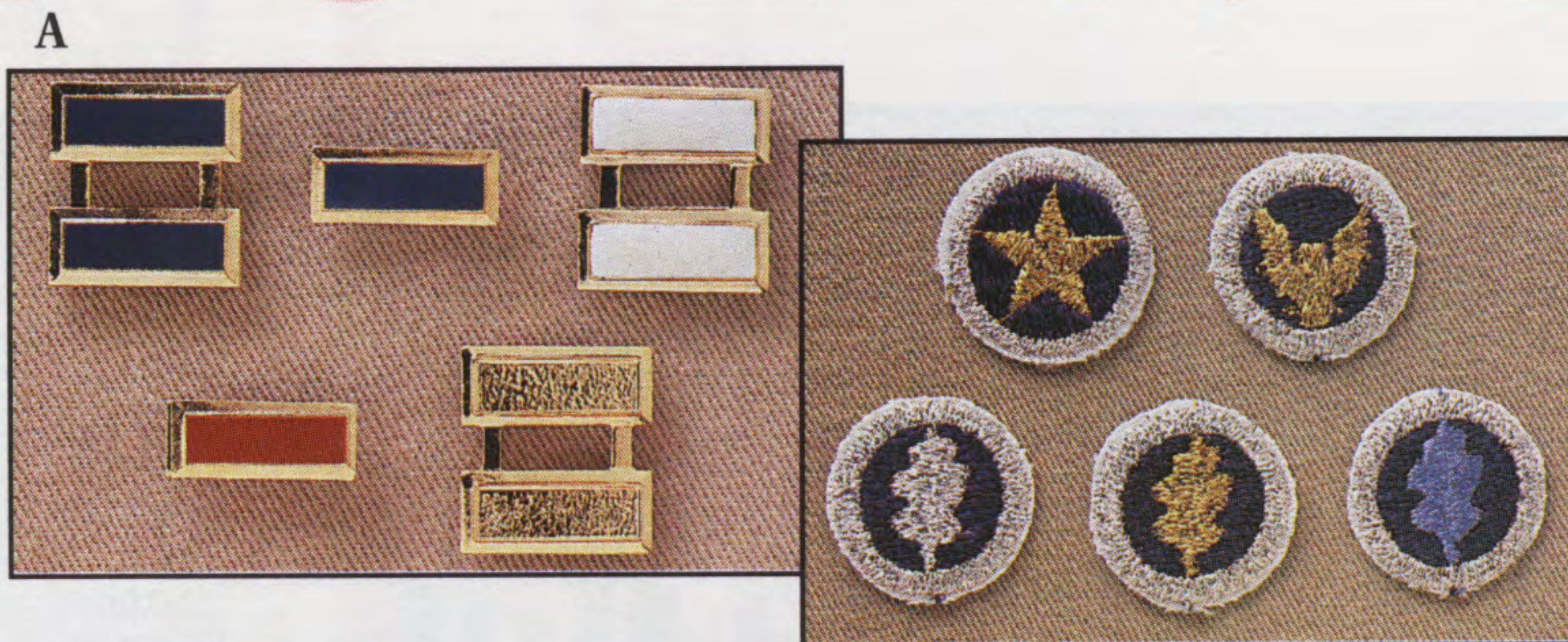

G. Royal Rangers Emblem. Official emblem embroidered in full-color on white twill background. 4 1/4" 15MX6936 \$2.25

H. Royal Rangers Emblem for Caps and Hats. Official emblem embroidered in full-color on white twill background. Can also be used for Buckaroos and Straight Arrows uniforms. 2 1/2" 15MX6946 \$2.00

I. Royal Rangers Tie Tac. Gold-plated with Royal Rangers emblem in colorful baked enamel. 15MX0173 \$3.95

J. Service Stars. Cloth embroidered. Wear on sleeves.
 1 Year—Gold 15MX0254
 5 Year—Silver 15MX0255
 79¢ each

K. Service Bars. Navy blue embroidered patches represent 10 or 20 years of service.
 10 Year—Gold 15MX0141
 20 Year—Silver 15MX0140
 79¢ each

L. Name Tabs.
 Buckaroos. Yellow embroidery on red twill. 15MX0253
 Pioneers. Red embroidery on white twill. 15MX6923
 Trailblazers. Brown embroidery on white twill. 15MX6924
 Challengers. Maroon embroidery on white twill. 15MX7060
 Royal Rangers (for Leaders). Navy blue embroidery on white twill. 15MX6941
 59¢ each

M. Guide Bar Collar Ornaments. Priced and sold in pairs.
 Assistant Guide. One gold bar on gold 15MX0728 \$4.95
 Guide. 2 gold bars on gold 15MX0729 \$4.95
 Senior Guide. 3 gold bars on gold 15MX0735 \$4.95

N. Dress Blazer Emblem. Gold and silver. Wear on dress blazer. 15MX6950 \$2.25

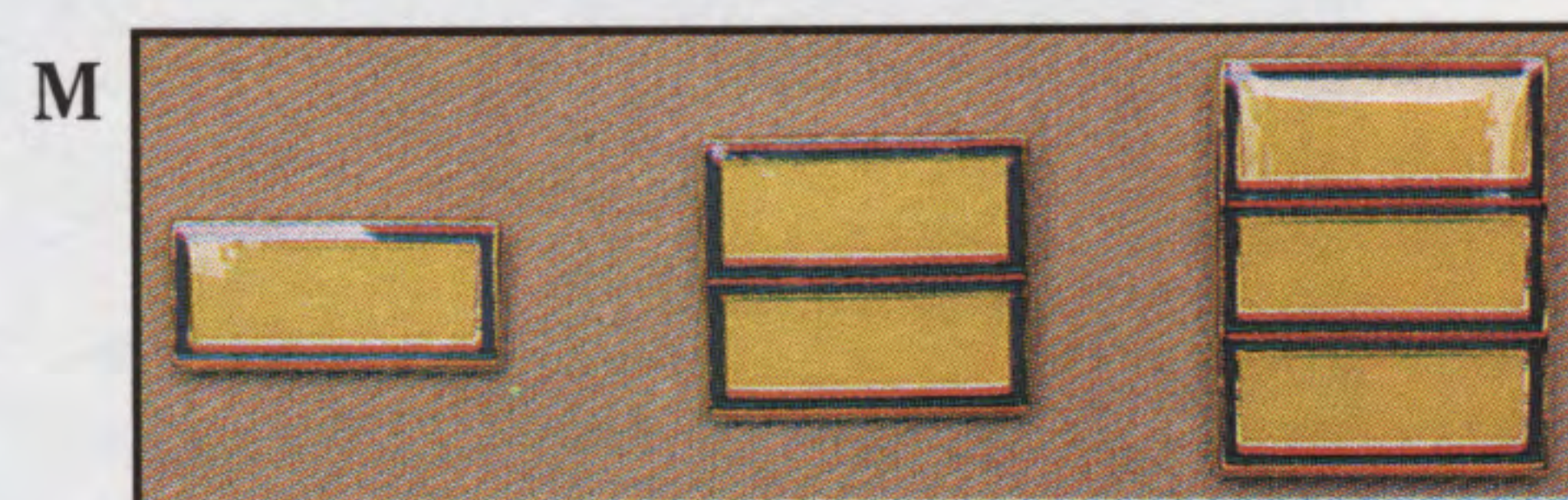

A. District Strips. 1 x 3 5/8"

- Alabama
- Alaska
- Appalachian
- Arizona
- Arkansas
- The Bahamas
- Central Latin
- Georgia
- German
- Gulf Latin
- Hawaii
- Illinois
- Indiana
- Iowa
- Kansas
- Kentucky
- Louisiana
- Michigan
- Midwest Latin
- Minnesota
- Mississippi
- Montana
- Nebraska
- New Jersey
- New Mexico
- New York
- N. Carolina
- N. Dakota
- N. Texas
- N. Cal.-Nevada
- N. Missouri
- N. New England
- N. Pacific Latin
- Northwest
- Ohio
- Oklahoma
- Oregon
- Pen. Florida
- Penn.-Del
- Potomac
- Puerto Rico
- Rocky Mountain
- S. Carolina
- S. Dakota
- S. E. Spanish
- S. Texas
- S. California
- S. Idaho
- S. Missouri
- S. New England
- S. Pacific Latin
- Spanish Eastern
- Tennessee
- West Florida
- West Texas
- Wis.-N. Mich
- Wyoming

75¢ each

Miniature District Strips. 3/4 x 2 3/4"

- Alabama
- Alaska
- Appalachian
- Arizona
- Arkansas
- The Bahamas
- Central Latin
- Georgia
- German
- Gulf Latin
- Hawaii
- Illinois
- Indiana
- Iowa
- Kansas
- Kentucky
- Louisiana
- Michigan
- Midwest Latin
- Minnesota
- Mississippi
- Montana
- Nebraska
- New Jersey
- New Mexico
- New York
- N. Carolina
- N. Dakota
- N. Texas
- N. Cal.-Nevada
- N. Missouri
- N. New England
- N. Pacific Latin
- Northwest
- Ohio
- Oklahoma
- Oregon
- Pen. Florida
- Penn.-Del.
- Potomac
- Puerto Rico
- Rocky Mountain
- S. Carolina
- S. Dakota
- S. E. Spanish
- S. Texas
- S. California
- S. Idaho
- S. Missouri
- S. New England
- S. Pacific Latin
- Spanish Eastern
- Tennessee
- West Florida
- West Texas
- Wis.-N. Mich
- Wyoming

65¢ each

- 15MX0540
- 15MX0541
- 15MX0542
- 15MX0543
- 15MX0544
- 15MX0611
- 15MX0545
- 15MX0546
- 15MX0610
- 15MX0547
- 15MX0548
- 15MX0549
- 15MX0550
- 15MX0551
- 15MX0552
- 15MX0553
- 15MX0554
- 15MX0555
- 15MX0556
- 15MX0557
- 15MX0558
- 15MX0559
- 15MX0560
- 15MX0561
- 15MX0562
- 15MX0563
- 15MX0564
- 15MX0565
- 15MX0566
- 15MX0567
- 15MX0568
- 15MX0569
- 15MX0848
- 15MX0570
- 15MX0571
- 15MX0572
- 15MX0573
- 15MX0575
- 15MX0576
- 15MX0577
- 15MX0578
- 15MX0579
- 15MX0580
- 15MX0581
- 15MX0593
- 15MX0582
- 15MX0583
- 15MX0584
- 15MX0585
- 15MX0586
- 15MX0849
- 15MX0592
- 15MX0587
- 15MX0588
- 15MX0589
- 15MX0590
- 15MX0591



B. Royal Rangers Sectional Staff Patch. Blue with gold lettering. Worn by sectional officials.
15MX0165 \$1.50

C. Royal Rangers Regional Staff Patch. Blue with gold lettering. Worn by regional officials.
15MX0156 \$1.65

D. Royal Rangers District Staff Patch. Blue with gold lettering. Worn by district officials.
15MX0164 \$1.50



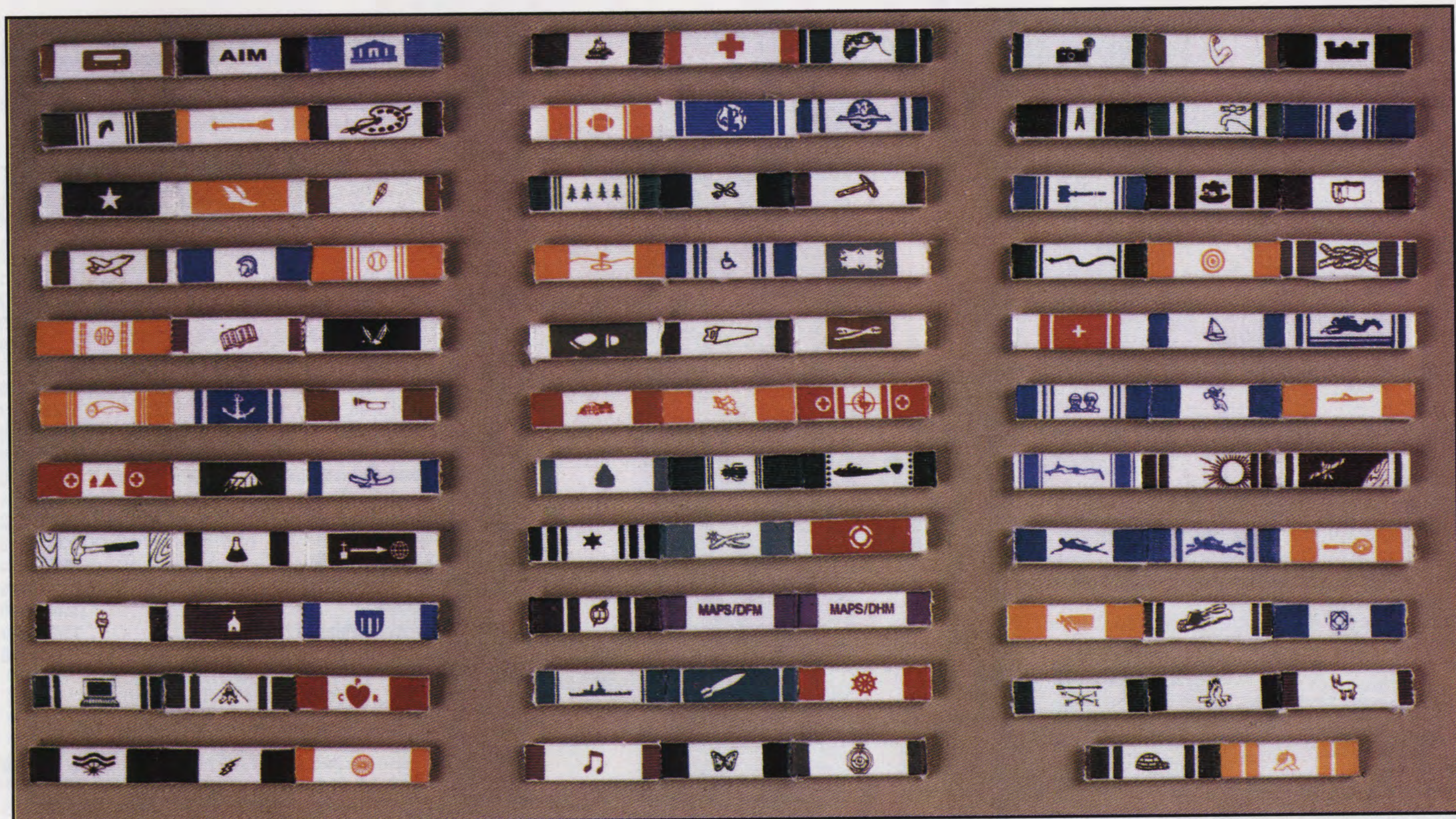

A. Merits. Given upon completion of the requirements designated for each category.

| | | | | | |
|---|----------|---|----------|--|----------|
| Amateur Radio. Radio | 15MX0421 | Electricity. Lightning | 15MX0370 | Nature Study. Butterfly | 15MX0444 |
| Ambassadors In Missions. AIM | 15MX0490 | Environment. Cloud/Sun/Rain | 15MX0764 | Pathfinder. Compass | 15MX0445 |
| American History. Monument | 15MX0751 | Firecraft. Fire | 15MX0488 | Photography. Camera | 15MX0446 |
| Animal Husbandry. Horse | 15MX0760 | First Aid. First Aid Cross | 15MX0437 | Physical Fitness. Arm | 15MX0447 |
| Archery. Arrow | 15MX0422 | Fishing. Fish | 15MX0454 | Pioneer Lore. Fortress | 15MX0768 |
| Art. Palette | 15MX0266 | Football. Football | 15MX0754 | Pioneering. Tower | 15MX0769 |
| Astronomy. Star | 15MX0423 | Foreign Language. Globe with "L" | 15MX0269 | Plumbing. Faucet | 15MX0272 |
| Athletics. Winged Foot | 15MX0424 | Foreign Missions. Open Bible and Candle | 15MX0270 | President's Award. Washington Silhouette | 15MX0763 |
| Auto. Spark Plug | 15MX0425 | Forestry. Trees | 15MX0746 | Public Speaking. Gavel | 15MX0762 |
| Aviation. Plane | 15MX0426 | Gardening. Shovel | 15MX0371 | Puppeteer. Puppet | 15MX0749 |
| Bachelor. Knight | 15MX0368 | Geology. Pick | 15MX0438 | Reading. Book | 15MX0375 |
| Baseball. Baseball | 15MX0755 | Golf. Golfing Flag | 15MX0752 | Reptile Study. Snake | 15MX0747 |
| Basketball. Basketball | 15MX0756 | Hide Tanning. Hide | 15MX0459 | Rifle Marksmanship. Target | 15MX0448 |
| Bible. Bible | 15MX0427 | Hiking. Footprint | 15MX0439 | Ropecraft. Rope | 15MX0456 |
| Bird Study. Bird | 15MX0428 | Hobby. Saw | 15MX0440 | Safety. Cross | 15MX0376 |
| Black Powder. Powder Horn | 15MX0745 | Home Repair. Pliers | 15MX0372 | Sailing. Sailboat | 15MX0453 |
| Boating. Anchor | 15MX0429 | Home Safety. House | 15MX0489 | Scuba Diving. Underwater Diver | 15MX0477 |
| Bugling. Bugle | 15MX0369 | Horsemanship. Saddle | 15MX0373 | Senior Citizens. Senior Citizens | 15MX0761 |
| Camp Safety. Fire/Hazard Sign | 15MX0767 | Hunter Safety. Sighted Deer | 15MX0744 | Sign Language. Hands | 15MX0377 |
| Camping. Tent | 15MX0430 | Indian Lore. Arrowhead | 15MX0441 | Skiing. Ski | 15MX0378 |
| Canoeing. Canoe | 15MX0431 | Insect Study. Ant | 15MX0748 | Skin Diving. Diver | 15MX0273 |
| Carpentry. Hammer | 15MX0267 | Journalism. Ink and Quill | 15MX0770 | Solar Science. Sun | 15MX0274 |
| Chemistry. Test Tube | 15MX0432 | Law Enforcement. Sheriff's Badge | 15MX0771 | Space Exploration. Spacecraft | 15MX0275 |
| Christian Missions. Cross Points to World | 15MX0750 | Leathercraft. Punch | 15MX0374 | Swimming. Swimmer | 15MX0449 |
| Christian Service. Torch | 15MX0433 | Lifesaving. Buoy | 15MX0442 | Swimming Advanced. Swimmer w/ Bars | 15MX0420 |
| Church. Church | 15MX0434 | Light-for-the-Lost. Bible/Torch | 15MX0498 | Tennis. Tennis Racket | 15MX0758 |
| Citizenship. Striped Shield | 15MX0435 | Missions Abroad Placement Service. MAPS/DFM | 15MX0495 | Track. Runner | 15MX0757 |
| Computer Science. Keyboard and Monitor | 15MX0268 | Mission America Placement Service. MAPS/DHM | 15MX0496 | Toolcraft. Ax and Log | 15MX0458 |
| Cooking. Kettle | 15MX0479 | | 15MX0496 | Water Safety. W.S.I. Life Saver | 15MX0457 |
| CPR-Cardiopulmonary Resuscitation. Heart | 15MX0455 | Model. Battleship | 15MX0765 | Weather. Weather Vane | 15MX0450 |
| Cycling. Wheel | 15MX0436 | Model Rocketry. Rocket | 15MX0271 | Wilderness Survival. Campfire | 15MX0451 |
| Disability Awareness. Wheelchair | 15MX0766 | Motor Boating. Helms | 15MX0478 | Wildlife. Elk | 15MX0452 |
| | | Music. Note | 15MX0443 | Winter Camping. Igloo | 15MX0379 |
| | | | | Wrestling. Arm Wrestling | 15MX0753 |

\$1.50 each

A. New Testament 2000 Pin. Award pin for boys and men who have read the entire New Testament. 3/4" 15MX0759 1.99

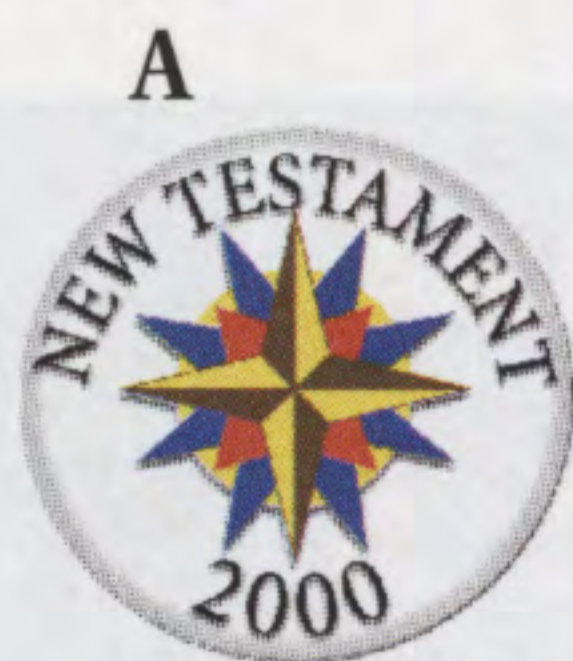

B. Royal Rangers Cut and Chop Card. Certifies that boys have passed a safety test. 2 x 3 1/2" 07MX5260 12 for 95¢ 50 for \$2.95



C. Royal Rangers First Aid Patch. Colorful patch to be worn by Royal Rangers successfully completing the American Red Cross First Aid Class. 1 7/8" dia. 15MX0793 \$2.25



D. Royal Rangers Gold Buffalo Pin. Gold-finish Medal of Achievement Award pin with clutch clasp. 3/8 x 5/8" 15MX0276 \$1.75

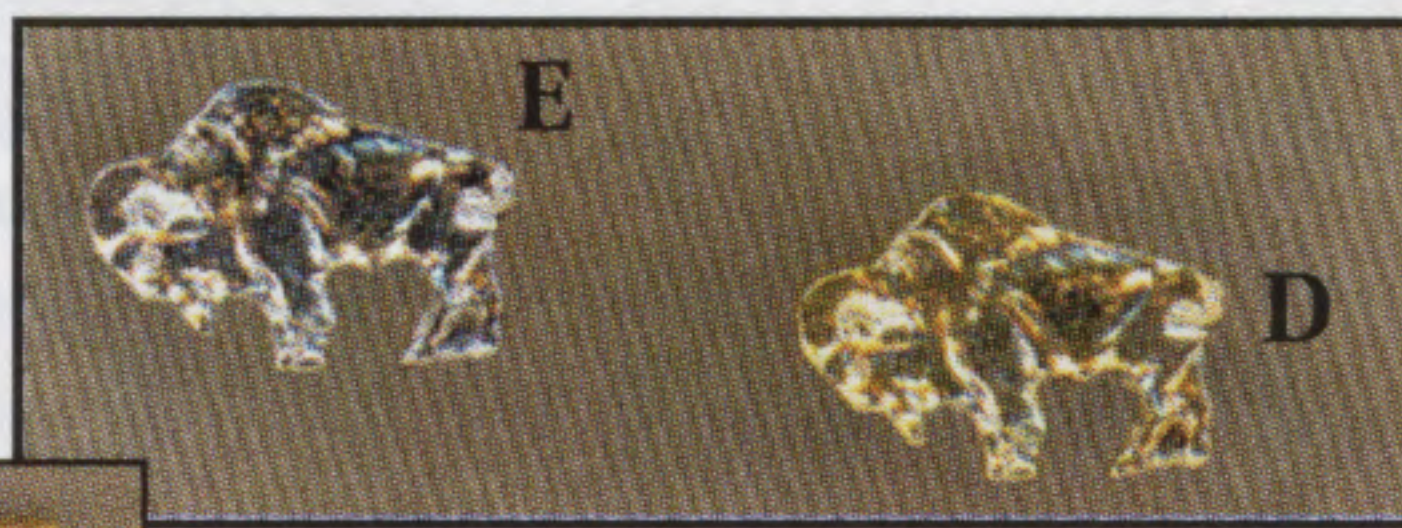

E. Royal Rangers Silver Buffalo Pin. Silver-finish Medal of Achievement Award pin with clutch clasp. 3/8 x 5/8" 15MX0279 \$1.75

F. LFTL Junior Councilmen Award. Round bronze medallion featuring the Light-for-the-Lost logo. Attached to 1 1/2" gold and green ribbon. Safety pin closure. 1 1/8" dia. 15MX0773 \$7.50



G. Royal Rangers Achievement Badges. Given upon completion of the requirements designated for each category.

- Arts. Art Brushes 15MX0820
 - Bible. Open Bible 15MX0821
 - Budget. Calculator 15MX0822
 - Church. Cross 15MX0823
 - Conservation. ECO Sign 15MX0824
 - Cooking. Cooking Pan and Fire 15MX0825
 - Craft. Craft Supplies 15MX0826
 - Drill Team. Trumpet 15MX0827
 - Friendship. Handshake 15MX0828
 - Home Improvement. Tools 15MX0829
 - Hygiene. Shower 15MX0830
 - Leadership. Boy Pointing 15MX0831
 - Map Orientation. Compass Point 15MX0832
 - Nature. Nature Scene 15MX0833
 - Outing. Tent 15MX0834
 - Physical Education. Torch 15MX0835
 - Public Service. Service Ribbon 15MX0836
 - Safety. First Aid Cross 15MX0837
 - School. Supplies 15MX0838
 - Sports. Sports Gear 15MX0839
 - Team Spirit. Hands United 15MX0840
 - Witnessing. Boy Witnessing 15MX0841
- \$1.25 each

H. Chi Omega Rho Advancement Patch. Light blue embroidered patches to signify various levels of achievement.

- Knight Baronet 15MX0142
 - Knight Bachelor 15MX0143
 - Knight Esquire 15MX0144
- \$2.25 each



I. Royal Rangers Certificate of Achievement. A framable certificate which recognizes when a Royal Ranger has achieved a higher or advanced rating. Includes space for name, rating, date, outpost church, and outpost commander. 8 1/2 x 11" 06MX5130 25 for \$6.95



J. Royal Rangers Advancement Awards Poster, updated. All the advancements, pins, chevrons, and advanced awards, including new achievement awards, are printed in full-color on heavy white paper. 20 x 26" 23MX8803 \$2.95



K. Royal Rangers Advancement and Training Records with Folder, updated. Keeps all advancement and training records for one boy in one place. Standard file-drawer size with a name space positioned for easy filing. Includes space for new achievement awards. 08MX0444 \$3.50

L. Royal Rangers Lock and Beads Award System. Recognizes Royal Rangers in areas of camping, field trips, and hikes; Sunday School and church attendance; Royal Rangers attendance; special service, projects, and events; and other outstanding accomplishments. Each award set contains a leather lock with Royal Rangers emblem and belt slits, 5 leather thongs, a bead identification chart, and instructions. Lock with Thongs 15MX0799 \$1.75

- Flat Bead, White 15MX0800
- Flat Bead, Blue 15MX0801
- Flat Bead, Black 15MX0802
- Flat Bead, Green 15MX0803
- Flat Bead, Yellow 15MX0804
- Flat Bead, Yellow/Tan 15MX0805
- Flat Bead, Dark Green 15MX0806
- Spherical Bead, Green 15MX0807
- Flat Bead, Clear 15MX0808
- Spherical Bead, Purple 15MX0809
- Flat Bead, Green/Marble 15MX0810
- Flat Bead, Blue/Marble 15MX0811
- Flat Bead, Orange 15MX0812
- Flat Bead, Brown 15MX0813
- Spherical Bead, White 15MX0814
- Spherical Bead, Red 15MX0815
- Flat Bead, Red 15MX0816
- Flat Bead, Red/Marble 15MX0817
- Flat Bead, Purple 15MX0818

20 for \$1.50
(Minimum of 20 of any color)

M. Royal Rangers Gold Wing Award. For boys and men who have earned their FAA private pilot's certificate or other U.S. federally recognized flight certificate. 15MX0402 \$5.95



A. Royal Rangers Outpost Flag Set. 8' 2-piece varnished hardwood pole with 6" gilded wood spear ornament, gilt-finish floor stand, and 3 x 5' Royal Rangers flag. 08MX5635 \$74.99

B. Royal Rangers Flag Desk Set. Displays the Royal Rangers, American, and Christian flags together. Vacuum black base. Flag size: 4 x 6" Height: 10 1/2" 08MX5632 \$7.50

C. Royal Rangers Outpost Flag. Colorful Royal Rangers emblem on white long-lasting Dura Lite nylon. Withstands wind fraying. 3 x 5' 08MX5613 \$36.95

D. Royal Rangers Outpost Patrol Flags. Colorful nylon flags with seamed ends at top and bottom. Choose from a variety of designs. Suitable for 3/4" dowel rods, designed to hang on staff. See chapter 2 of the Royal Rangers Leaders Manual for more information about patrol systems. 10 x 14"

- | | |
|----------|----------|
| Antelope | 08MX1080 |
| Bear | 08MX1081 |
| Beaver | 08MX1082 |
| Bobcat | 08MX1083 |
| Buffalo | 08MX1084 |
| Cougar | 08MX1085 |
| Elk | 08MX1087 |
| Fox | 08MX1088 |
| Gator | 08MX1089 |
| Hawk | 08MX1090 |
| Owl | 08MX1091 |

\$10.95 each

A



B



D

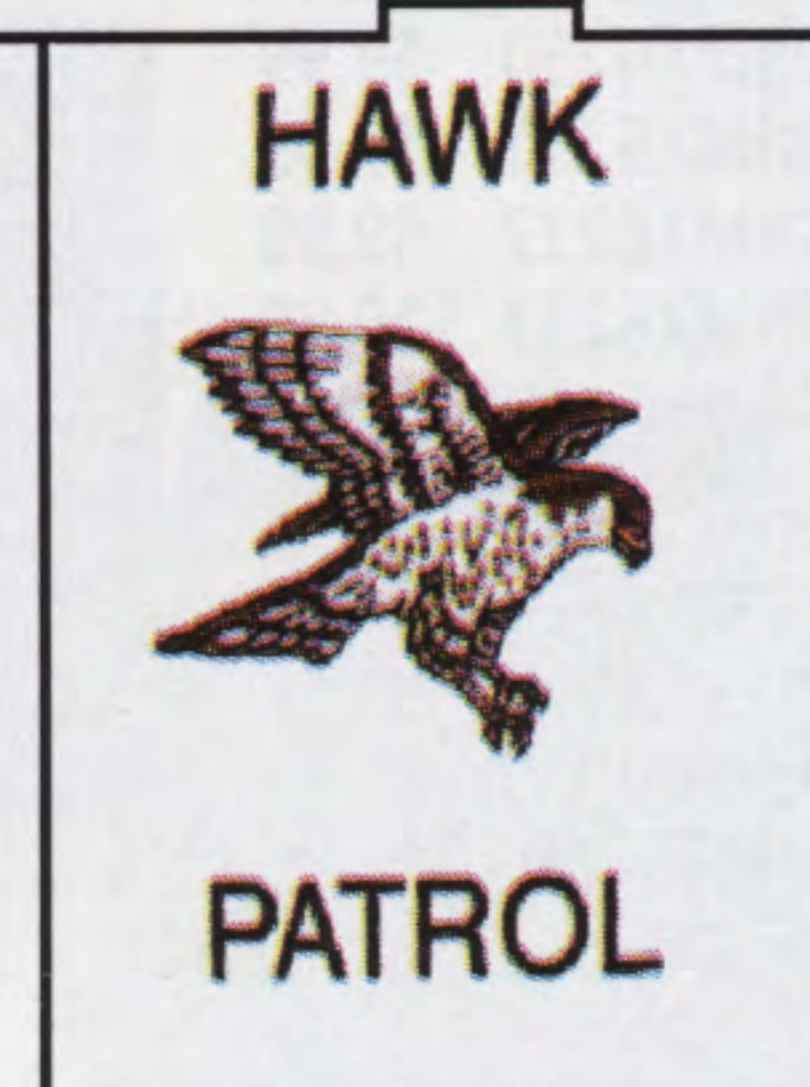
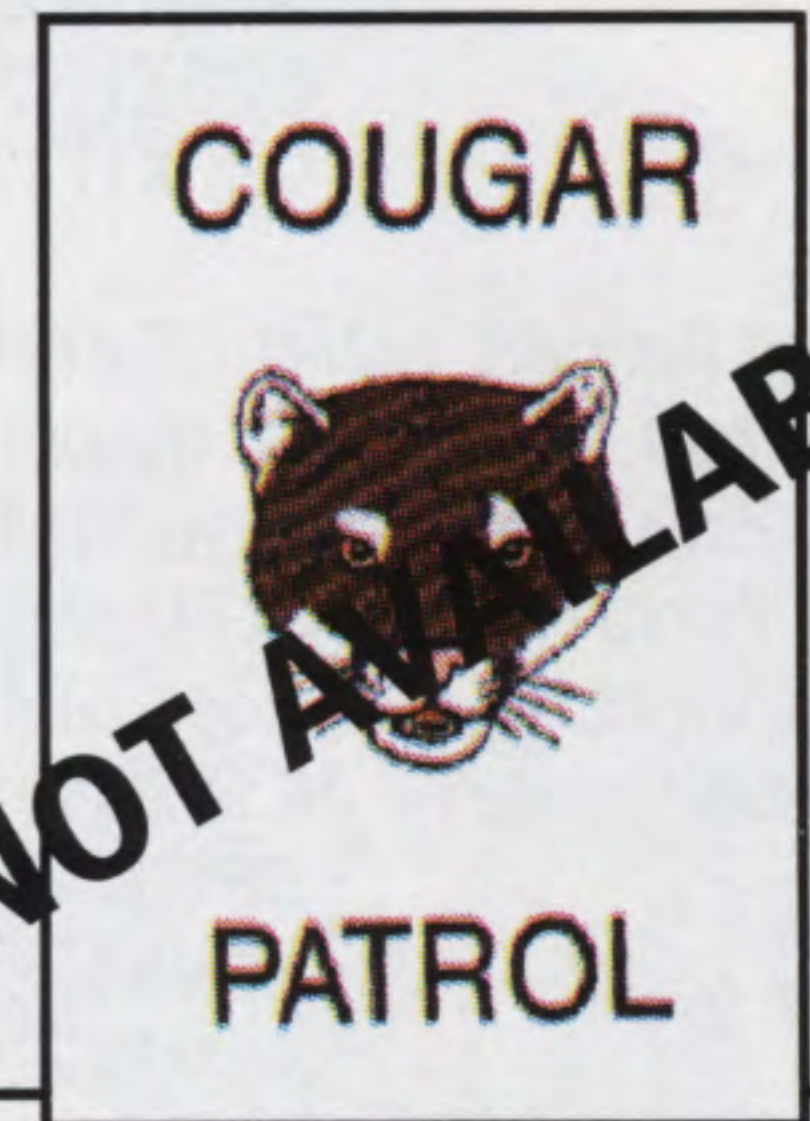
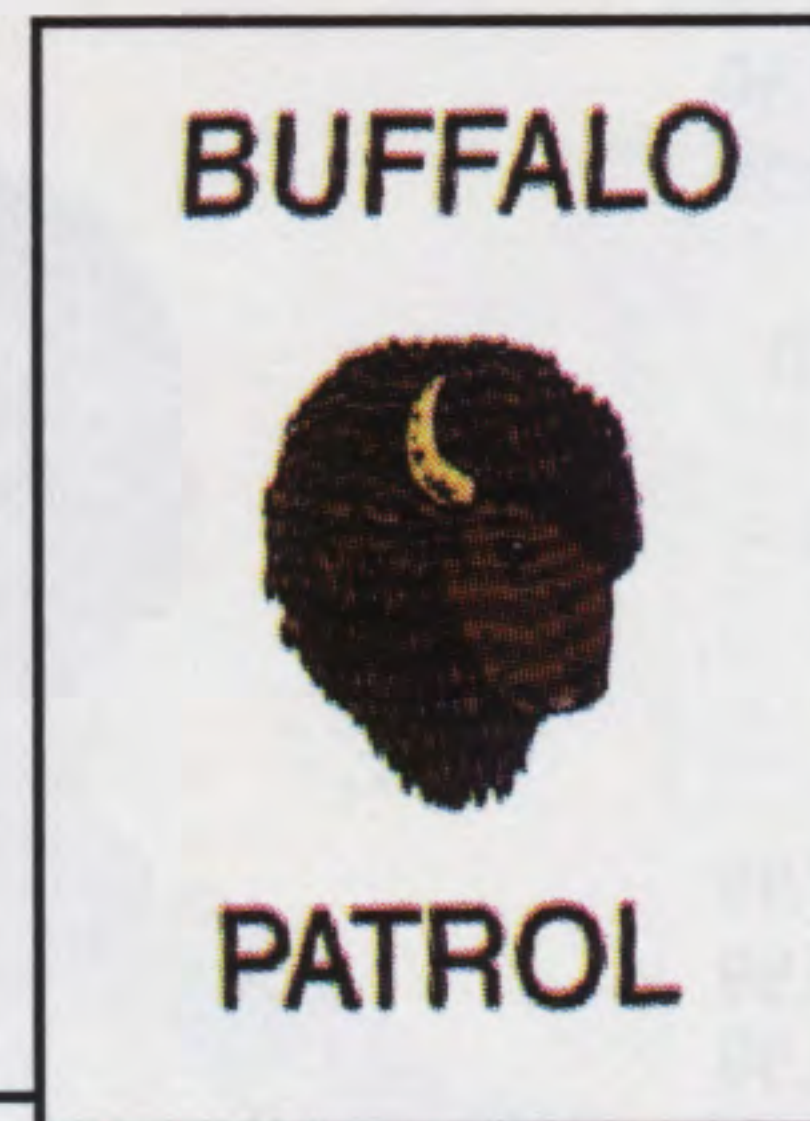
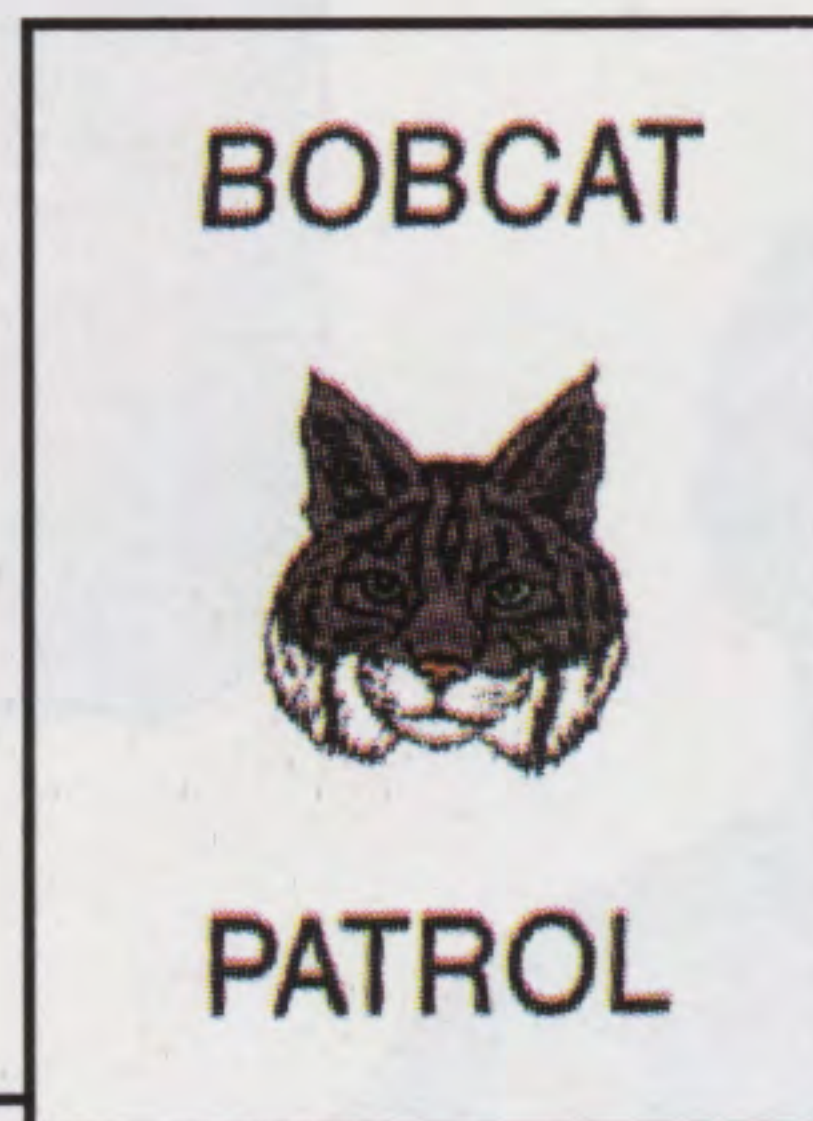

A. "Ready for Anything" T-shirts. Black 100% heavy-weight, preshrunk cotton T-shirt has "Ready." imprinted in white on front and "Ready for Anything. Period!" and Royal Rangers imprinted on back.

| | | |
|----------------|----------|---------|
| Boys S (6-8) | 08MX1411 | \$8.99 |
| Boys M (10-12) | 08MX1412 | \$8.99 |
| Boys L (14-16) | 08MX1413 | \$8.99 |
| Adult S | 08MX1414 | \$9.99 |
| Adult M | 08MX1415 | \$9.99 |
| Adult L | 08MX1416 | \$9.99 |
| Adult XL | 08MX1417 | \$9.99 |
| Adult 2XL | 08MX1418 | \$10.99 |
| Adult 3XL | 08MX1419 | \$12.50 |
| Adult 4XL | 08MX1420 | \$16.50 |

B. "Ready" Low-profile Cap. Forest green, brushed cotton, low-profile cap with "Ready." embroidered on front and "Royal Rangers" on back. Adjustable strap.

08MX1410 \$12.99

C. Royal Rangers T-shirt, Center Front Emblem. White shirts with colorful Royal Rangers emblem. 50% polyester and 50% cotton.

| | | |
|----------------|----------|---------|
| Boys S (6-8) | 08MX0253 | \$7.99 |
| Boys M (10-12) | 08MX0255 | \$7.99 |
| Boys L (14-16) | 08MX0256 | \$7.99 |
| Adult S | 08MX0257 | \$8.99 |
| Adult M | 08MX0258 | \$8.99 |
| Adult L | 08MX0259 | \$8.99 |
| Adult XL | 08MX0260 | \$8.99 |
| Adult 2XL | 08MX0298 | \$9.99 |
| Adult 3XL | 08MX1735 | \$12.50 |
| Adult 4XL | 08MX0316 | \$16.50 |

D. Royal Rangers T-shirt, Left Front Emblem. Colorful Royal Rangers emblem on white, 50% polyester and 50% cotton shirts.

| | | |
|----------------|----------|---------|
| Boys S (6-8) | 08MX0700 | \$7.99 |
| Boys M (10-12) | 08MX0701 | \$7.99 |
| Boys L (14-16) | 08MX0703 | \$7.99 |
| Adult S | 08MX0704 | \$8.99 |
| Adult M | 08MX0705 | \$8.99 |
| Adult L | 08MX0706 | \$8.99 |
| Adult XL | 08MX0707 | \$8.99 |
| Adult 2XL | 08MX0723 | \$9.99 |
| Adult 3XL | 08MX1736 | \$12.50 |
| Adult 4XL | 08MX1737 | \$16.50 |

E. Royal Rangers Starburst T-shirt. Light gray T-shirt with Royal Rangers logo and "Royal Rangers" spelled out in red and blue on upper left chest. 50% polyester and 50% cotton.

| | | |
|---------------|----------|---------|
| Youth (10-12) | 08MX1053 | \$6.95 |
| Youth (14-16) | 08MX1054 | \$6.95 |
| Adult S | 08MX1055 | \$7.95 |
| Adult M | 08MX1056 | \$7.95 |
| Adult L | 08MX1057 | \$7.95 |
| Adult XL | 08MX1058 | \$7.95 |
| Adult 2XL | 08MX1059 | \$8.95 |
| Adult 3XL | 08MX1738 | \$12.50 |
| Adult 4XL | 08MX1739 | \$16.50 |

F. "Special Forces" Royal Rangers T-shirt. T-shirt with "Special Forces" imprinted in dark red across the front. Full-color Royal Rangers emblem imprinted below collar on back. Youth sizes are 50% cotton/50% polyester blend; adult sizes are 100% cotton. Available in stone color.

| | | |
|----------------|----------|---------|
| Boys M (10-12) | 08MX6227 | \$8.99 |
| Boys L (14-16) | 08MX6228 | \$8.99 |
| Adult S | 08MX6229 | \$9.99 |
| Adult M | 08MX6230 | \$9.99 |
| Adult L | 08MX6231 | \$9.99 |
| Adult XL | 08MX6232 | \$9.99 |
| Adult 2XL | 08MX6233 | \$10.99 |

G. Royal Rangers 2-tone Low-profile Cap. Khaki crown with faded royal blue bill. Royal Rangers emblem is embroidered on front of cap. Brushed cotton with matching fabric strap closure and snapped brass buckle.

08MX6240 \$12.99

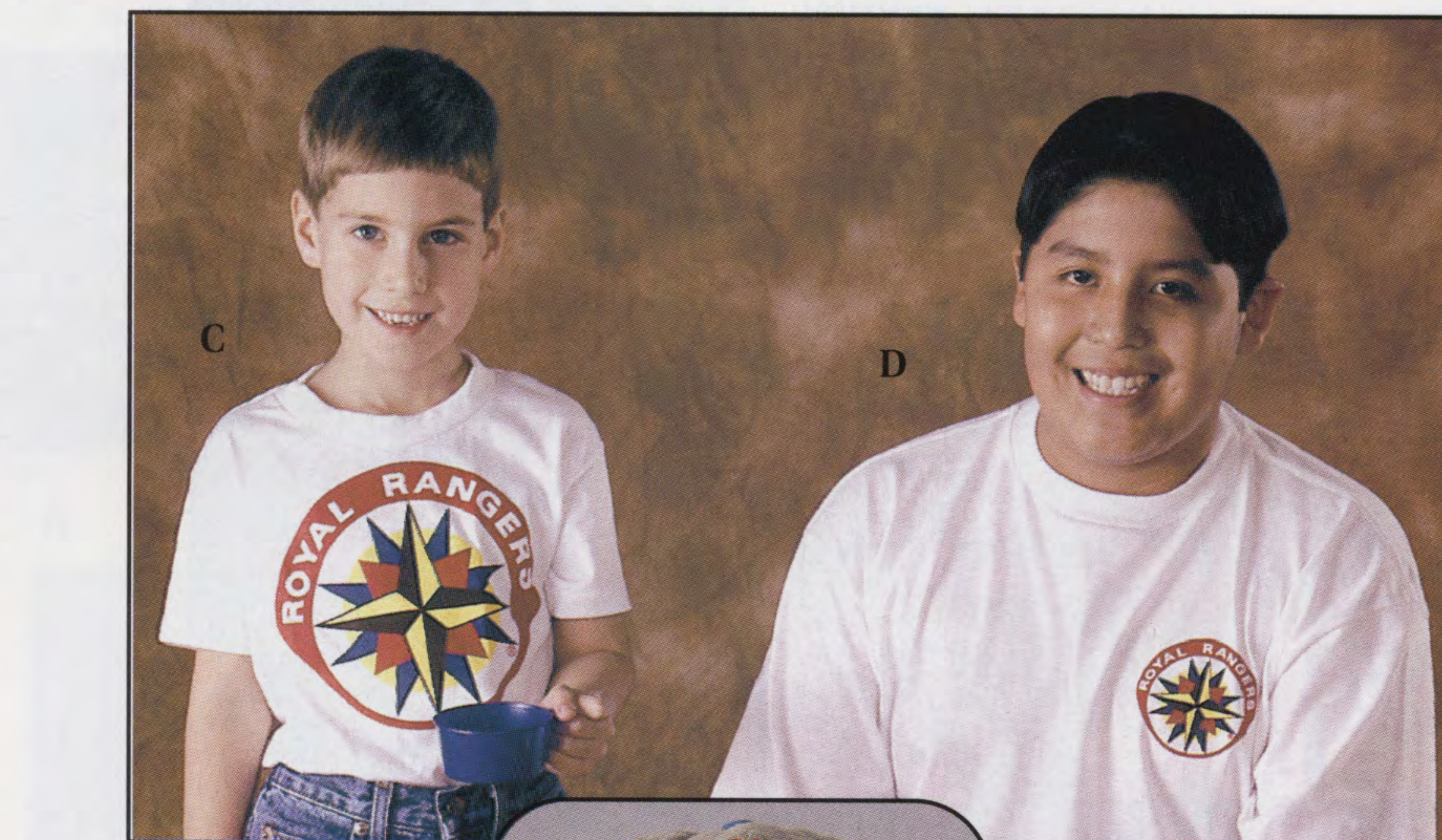



NEW!

B

NEW!

A

NEW!

C



A. Navy Deluxe Polo Shirt. 100% pre-shrunk navy blue cotton pique with Royal Rangers emblem embroidered on left chest.

| | | |
|-----------|----------|---------|
| Adult M | 08MX6216 | \$27.99 |
| Adult L | 08MX6217 | \$27.99 |
| Adult XL | 08MX6218 | \$27.99 |
| Adult 2XL | 08MX6219 | \$29.99 |

B. Black Low-profile Cap with Royal Rangers Emblem.

Pro-style, low-crown, brushed cotton cap with matching fabric snap closure and antique brass buckle. Royal Rangers emblem embroidered on front of cap. 08MX6220 \$12.99

C. Natural Polo Shirt with Maroon Collar and Royal Rangers Embroidered on Left Chest. 100% heavyweight cotton herringbone natural polo shirt with contrasting burgundy knit jacquard collar and welt cuffs. Royal Rangers embroidered on left chest in burgundy.

| | | |
|-----------|----------|---------|
| Adult M | 08MX6222 | \$32.99 |
| Adult L | 08MX6223 | \$32.99 |
| Adult XL | 08MX6224 | \$32.99 |
| Adult 2XL | 08MX6225 | \$34.99 |

D. Royal Rangers Long Sleeve T-shirt. White T-shirt with ribbed neck and wrists. Features "Royal Rangers" spelled out in red and blue on upper left chest and on right sleeve. 50% cotton, 50% polyester.

| | | |
|----------------|----------|---------|
| Boys M (10-12) | 08MX0766 | \$8.95 |
| Boys M (14-16) | 08MX0767 | \$8.95 |
| Adult S | 08MX0768 | \$9.95 |
| Adult M | 08MX0769 | \$9.95 |
| Adult L | 08MX0770 | \$9.95 |
| Adult XL | 08MX0771 | \$9.95 |
| Adult 2XL | 08MX0772 | \$10.95 |

E. JCID Tags. Solid pewter dog-tag style tags with 30" ball chain.

| | | |
|--------------|----------|--------|
| Fear Not Tag | 17MX7373 | \$6.00 |
| Sold Out Tag | 17MX7374 | \$6.00 |

F. Camp Eagle Rock T-shirt. Ash gray T-shirt with eagle, Royal Rangers logo, frontier designs, and "Camp Eagle Rock" imprinted in color. 50% cotton and 50% polyester.

| | |
|-----------|----------|
| Adult L | 72MX9061 |
| Adult XL | 72MX9062 |
| Adult 2XL | 72MX9063 |

\$11.50 ea.; 10 or more, \$10.00 ea.



E

D



F

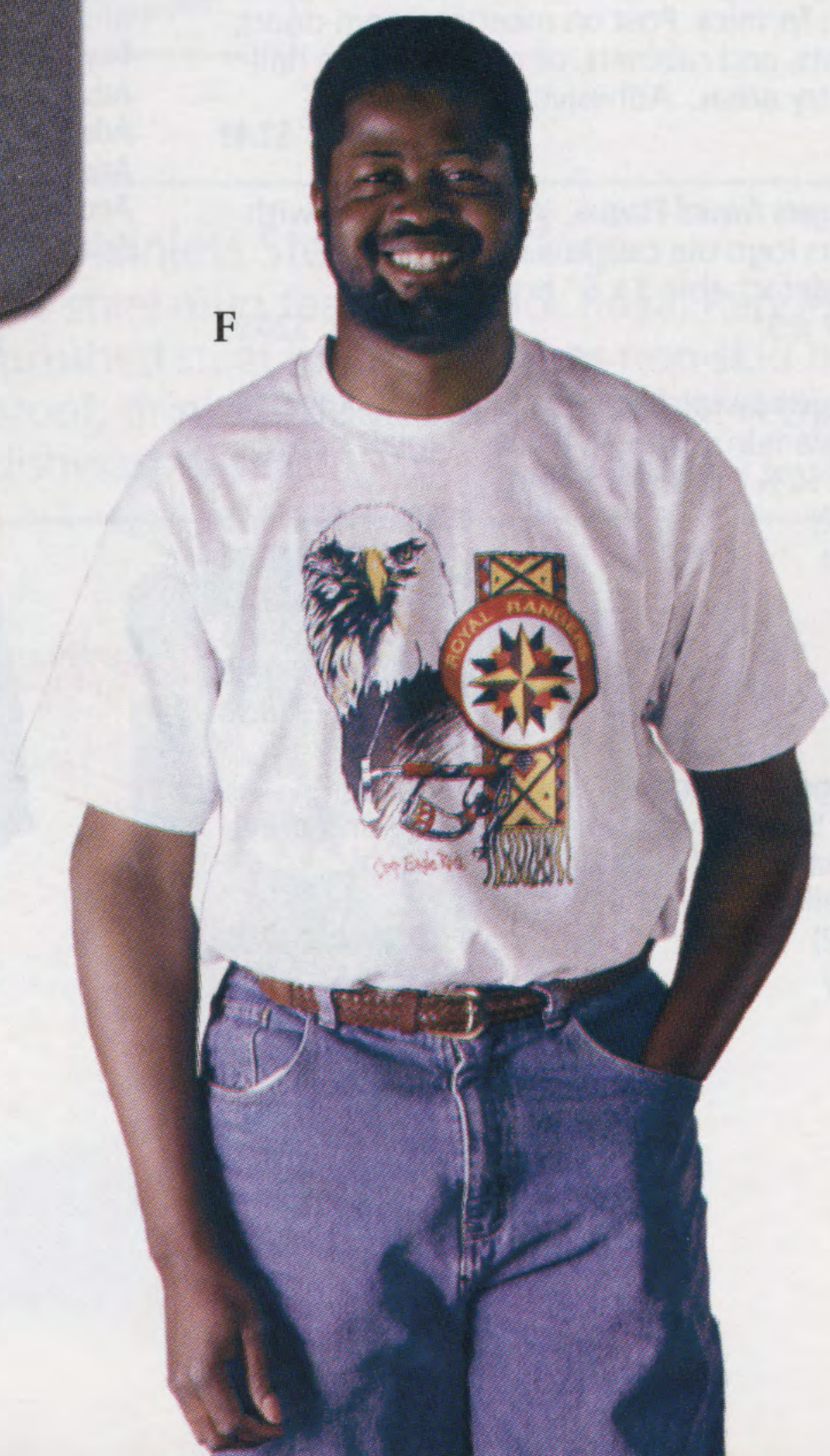

A. Royal Rangers Poster. Colorful Royal Rangers emblem printed on heavy white stock suitable for framing. 20 x 26" **23MX8835 \$1.95**

B. Royal Rangers Code Poster, revised. Red and black code poster for your outpost. 20 x 26" **23MX8801 \$1.95**

C. Royal Rangers Pledge Poster. Companion poster for the Royal Ranger Code Poster. 20 x 26" **23MX8802 \$1.95**

D. Royal Rangers Bulletin. Outside features colorful Royal Rangers camping scene. Inside is ready for printing. **08MX1279 50 for \$3.48 1000 for \$56.50**

E. Gold Medal of Achievement Bulletin. Colorfully imprinted on the outside front with "Gold Medal Court of Honor" and the medal. Wording on back: "A man never stands quite so tall as when he stoops to help a boy." Inside is blank and ready for printing. **72MX9069 100 for \$15.00**

F. Royal Rangers New Testament. The official Royal Rangers New Testament. Features a presentation page, Royal Rangers code, motto, pledge, and plan of salvation Scriptures. Dark blue morocco cover. Black letter edition on Bible paper. Front and back-bone stamped with non-tarnish gold. Royal Rangers emblem on front. 3 x 4 1/2"

KJV **01MX0411**
NIV **01MX0694**
\$3.99 each

G. Royal Rangers Decal. Large decal for use on camping equipment, supplies, car doors, and trailers. 15 3/8 x 15 1/2" **14MX6802 \$3.95**

H. Royal Rangers Decal. Colorful, self-adhesive emblem to use on luggage, notebooks, camping equipment, and other items. 3 3/4 x 4 1/8" **14MX6840 50¢ ea. 3 for \$1.25 12 for \$3.95**

I. Royal Rangers Bumper Sticker. White vinyl bumper sticker with the Royal Rangers emblem. Reads: "Royal Rangers—Developing the Total Boy for Christ." 3 x 11 3/8" **17MX7164 69¢ ea. 10 for \$4.95**

J. Royal Rangers Sign. Engraved white lettering on walnut-grain formica. Post on meeting room doors, storage closets, and cabinets, or place them in hallways and entry areas. Adhesive back. 2 x 8" **08MX0504 \$3.49**

K. Royal Rangers Award Plaque. Walnut veneer with Royal Rangers logo die cast in a bronze finish. Comes with detachable 3 x 5" brass plate for engraving. 7 x 9" **21MX8210 \$20.95**

L. Royal Rangers Sweatshirt. Navy blue with Royal Rangers emblem in white on front. Raglan sleeve. 50% cotton, 50% polyester blend.
Youth M (10-12) **08MX0261 \$10.95**
Youth L (14-16) **08MX0262 \$10.95**
Adult M **08MX0264 \$11.95**
Adult L **08MX0265 \$11.95**
Adult XL **08MX0278 \$11.95**
Adult 2XL **08MX0297 \$13.95**

M. Royal Rangers Sweatpants. Soft, comfortable 50% cotton, 50% polyester blend. Elastic and draw-string waistband, and elastic ankles. "Royal Rangers" spelled down the left leg.
Youth M (10-12) **08MX0944 \$12.95**
Youth L (14-16) **08MX0945 \$12.95**
Adult M **08MX0946 \$14.95**
Adult L **08MX0947 \$14.95**
Adult XL **08MX0948 \$14.95**
Adult 2XL **08MX0949 \$14.95**

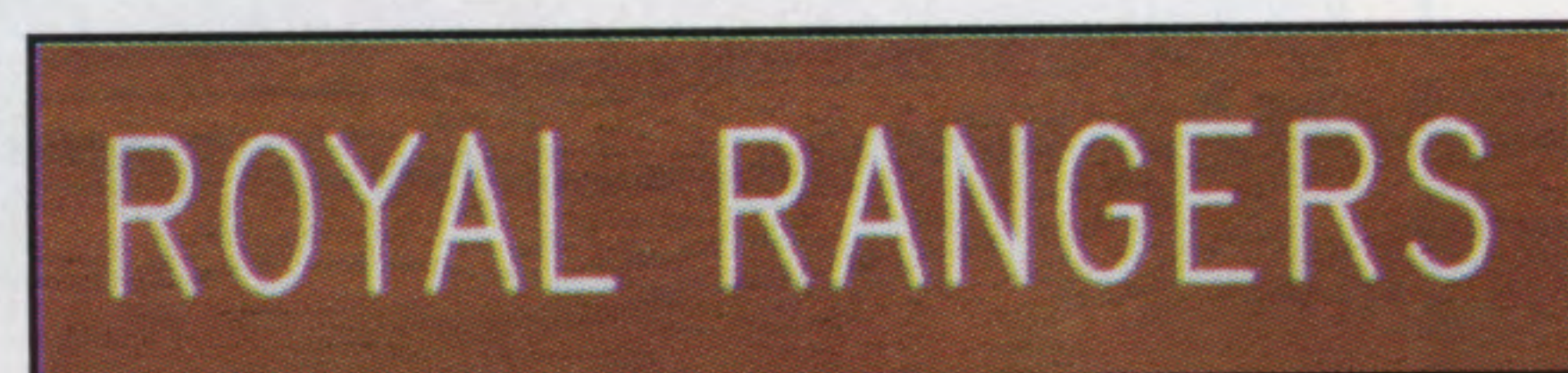
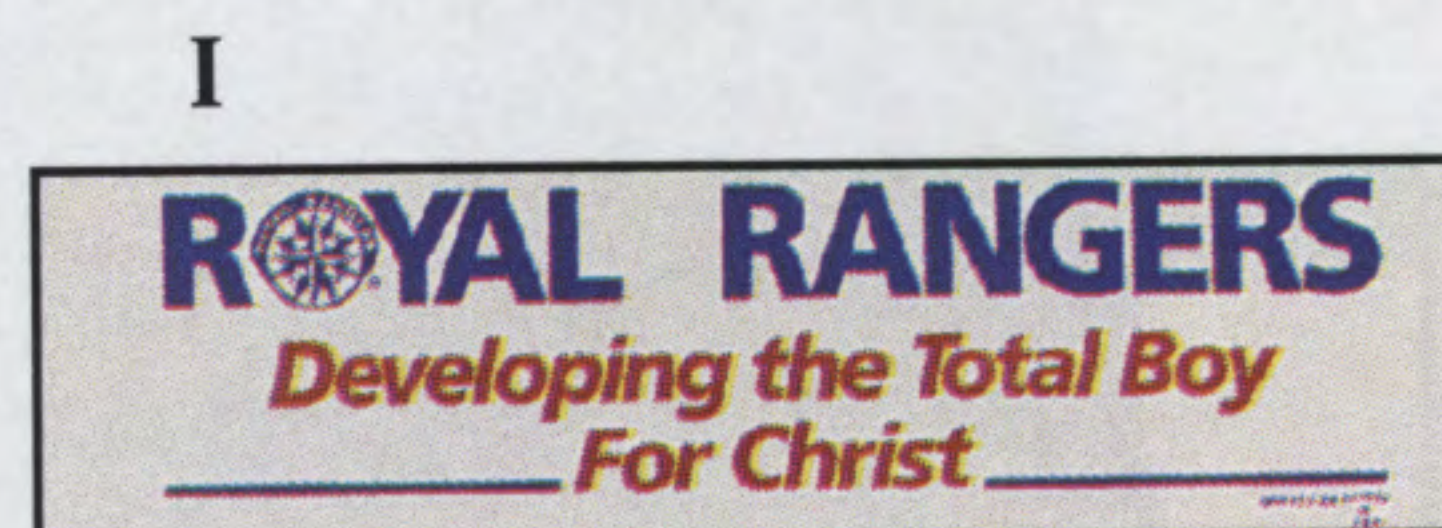
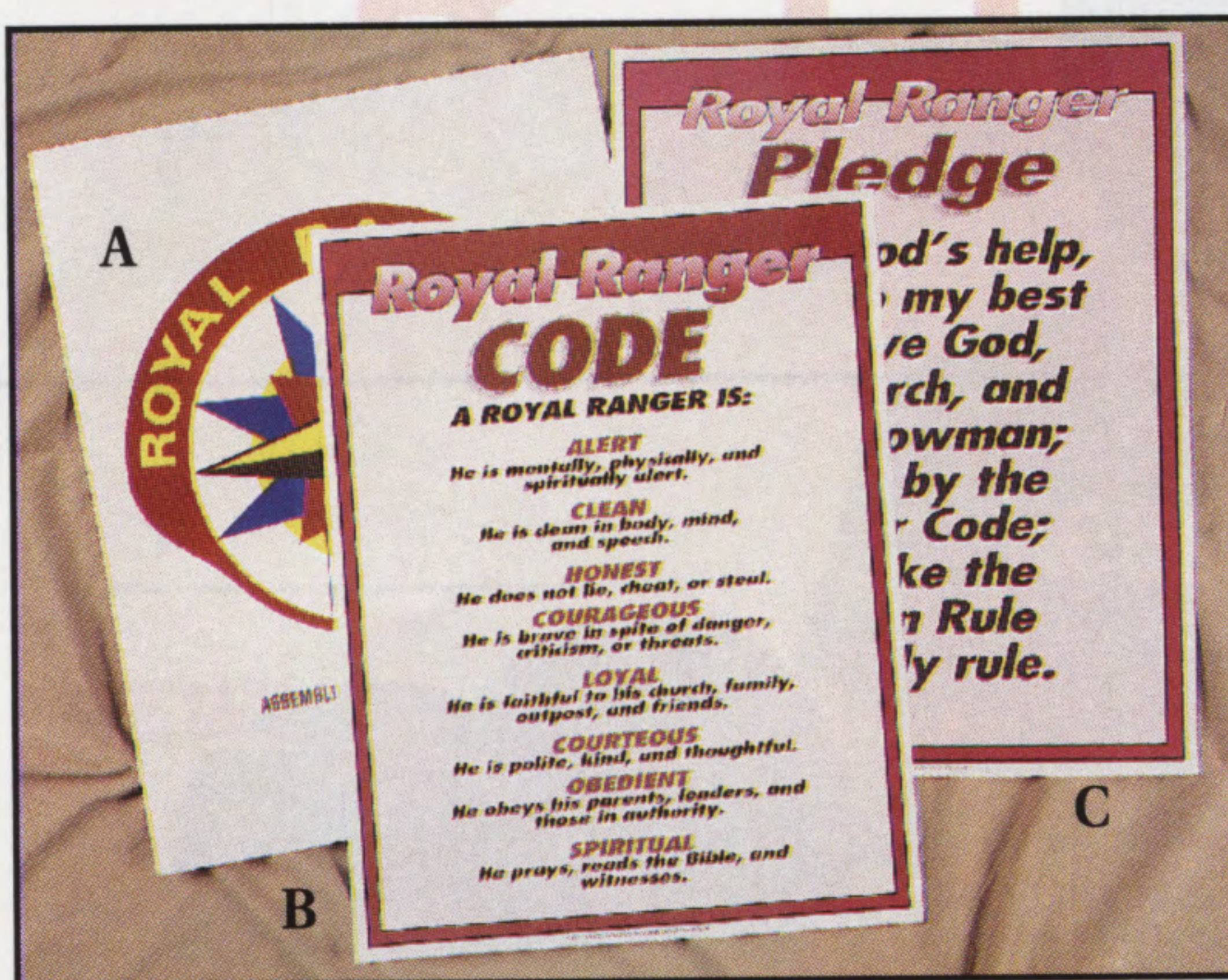

N. Royal Rangers Jacket with Quilted Lining. Navy jacket with 100% polyester quilted lining (machine washable). Jacket shell is made of 100% nylon. Set-in sleeves, knit trim cuffs and waistband, overlapping pockets, and shoulder loops hold epaulets with single-snap closure. Zippered front closure. Royal Rangers embroidered emblem sewn on upper left chest.
Adult L **08MX0295**
Adult XL **08MX0296**
Adult 2XL **08MX0292**
\$42.95 each

O. Royal Rangers Lightweight Unlined Jacket. Unlined jacket is 100% nylon. Jacket shell is identical in style and fabric to the Jacket with Quilted Lining.
Boys M (10-12) **08MX0267 \$31.50**
Adult S **08MX0269 \$32.50**
Adult L **08MX0275 \$32.50**
Adult XL **08MX0276 \$32.50**
Adult 2XL **08MX0263 \$34.95**
Adult 4XL **08MX0251 \$46.95**

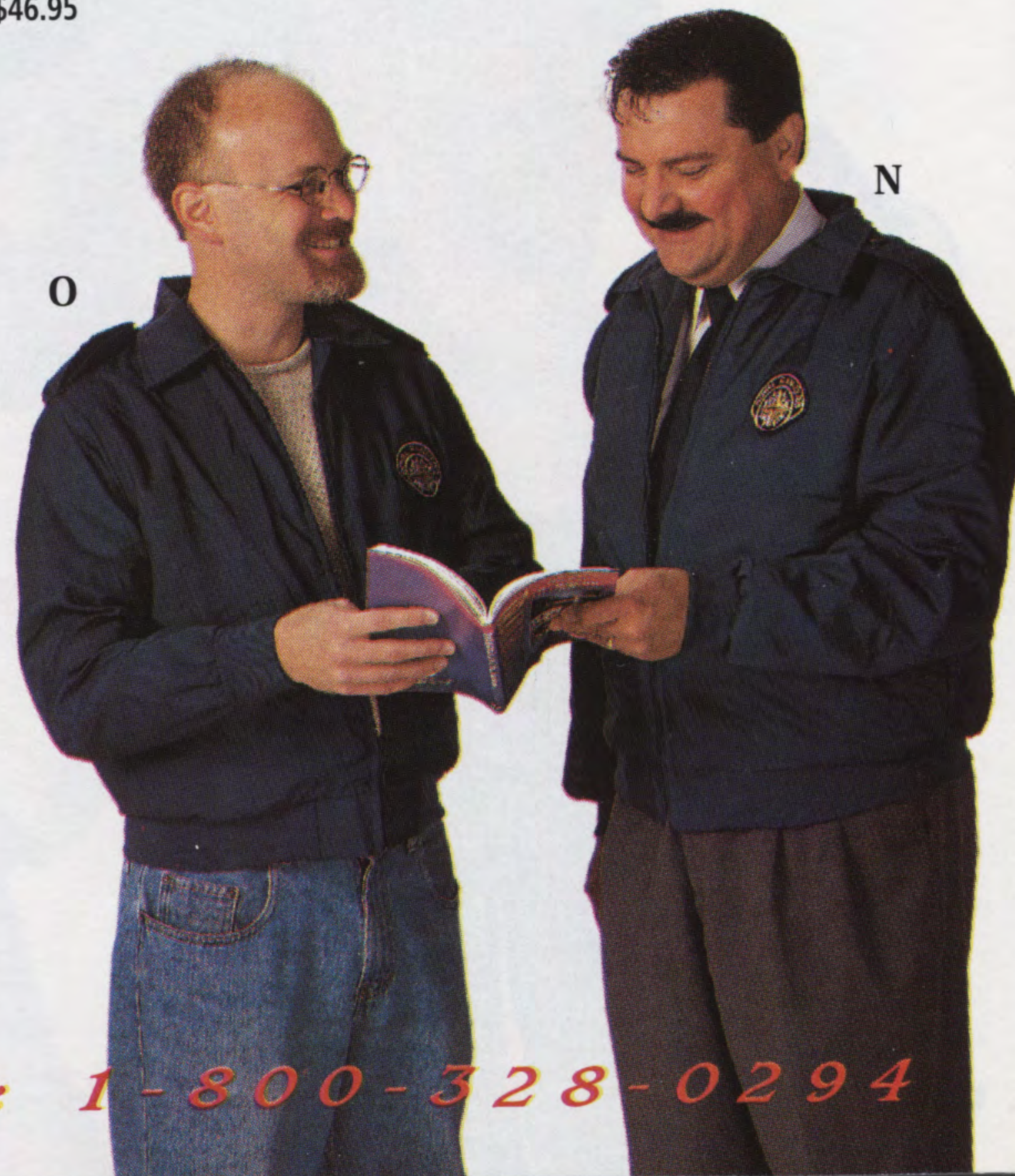

A. Royal Rangers Ring. This handsome sterling silver ring features the Royal Rangers insignia and comes in a black velvet ring box. Insignia size: 11/16"

| | |
|--------|----------|
| 9 1/2 | 17MX0262 |
| 10 | 17MX0263 |
| 10 1/2 | 17MX0264 |
| 11 | 17MX0265 |
| 11 1/2 | 17MX0266 |
| 12 | 17MX0267 |
| 12 1/2 | 17MX0268 |

\$79.95 each

B. Royal Rangers Buck Knife—Folding Hunter. Rounded gold end with Royal Rangers emblem on one side. Sharpens easily and stays sharp. Comes with black leather sheath. 4 7/8" 17MX0213 \$54.99

C. Rangerlite Buck Knife. The official Royal Rangers Buck knife with sheath. Features a high-chrome, high-carbon, rust-resistant steel blade with positive lock-open action. Handle is Valox—a high-test, engineering quality plastic. The sheath is made of black nylon. Length: Closed 4 1/4"; clip blade 3". 17MX7162 \$30.99

D. Royal Rangers Buck Knife—Esquire. Easy to sharpen and stays that way. Slightly rounded silver end. Royal Rangers emblem imprinted on one side. Comes in black leather sheath. 3/4 x 3" 17MX0214 \$46.99

E. Royal Rangers Thermal Mug. Dark blue mug with white Royal Rangers emblem and no-spill lid. 22 oz. 17MX0294 \$4.25

F. Royal Rangers Wallet. Brown nylon with Velcro™ closing features a gold Royal Rangers emblem and a pencil holder. 17MX0167 \$4.95

G. Royal Rangers Leaders Belt Buckle. Features the Royal Rangers emblem. 2 3/8 x 2 5/8"
 Brass finish 08MX0231
 Pewter finish 08MX0232
 \$14.95 each

H. Sports Bag. Navy blue cotton canvas with reinforced web straps and self-repairing zipper. Features white imprinted Royal Rangers emblem. 9 x 16" 17MX0169 \$12.99

I. Royal Rangers Neckerchief Slide. Silver marbon plastic featuring the Royal Rangers emblem. 1 1/4" dia. 08MX0153 \$2.95

J. Royal Rangers Key Ring. Durable lucite, featuring colorful Royal Rangers emblem. Triangular. 15MX0412 \$2.95



Royal Rangers Stainless Steel Travel Mug.
 16 oz. stainless steel mug features black Royal Rangers emblem on brushed steel finish. Mug has non-skid bottom and splash-proof, drink through lid. Mug is not recommended as dishwasher safe. 17MX7531 \$15.99



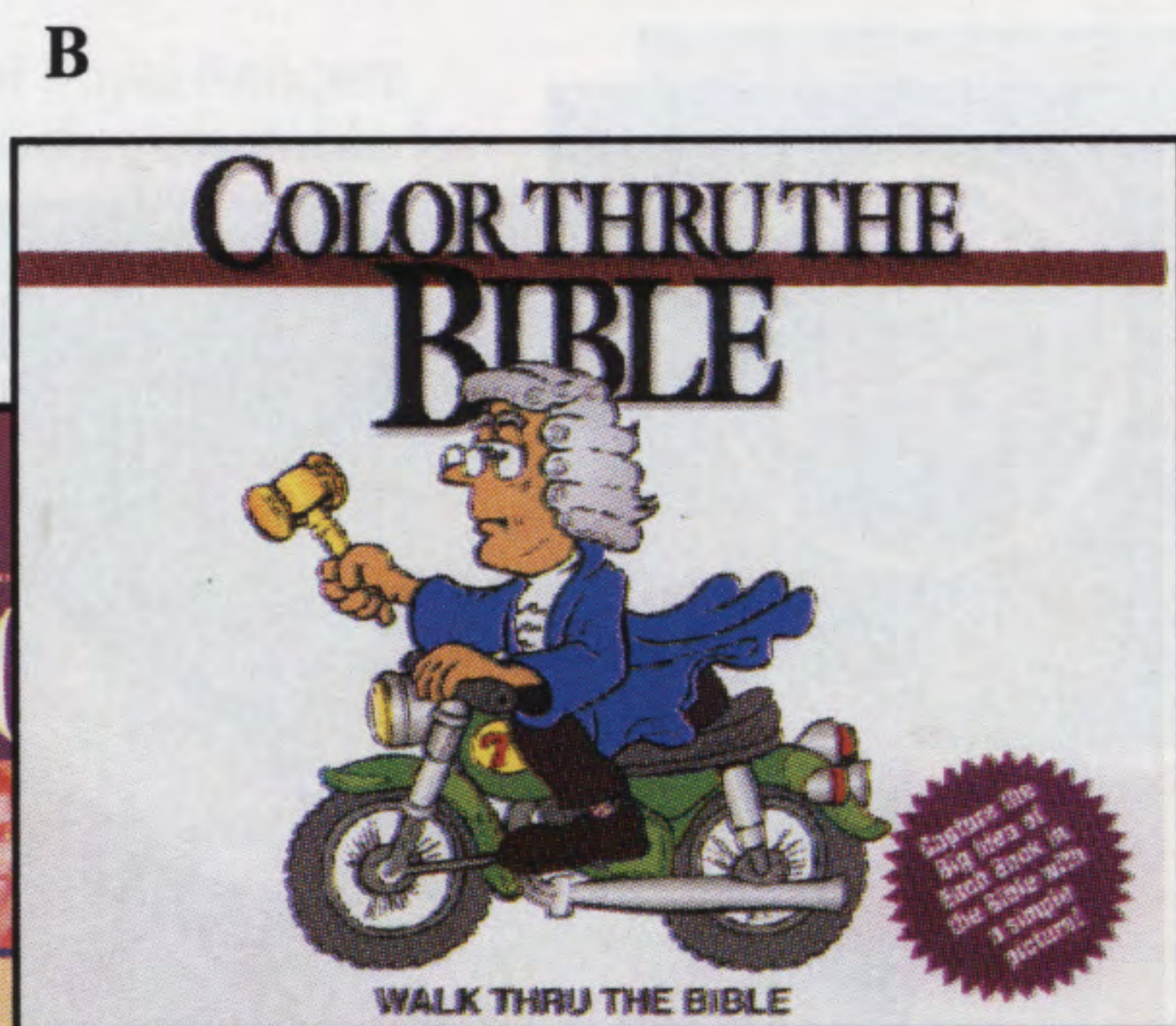
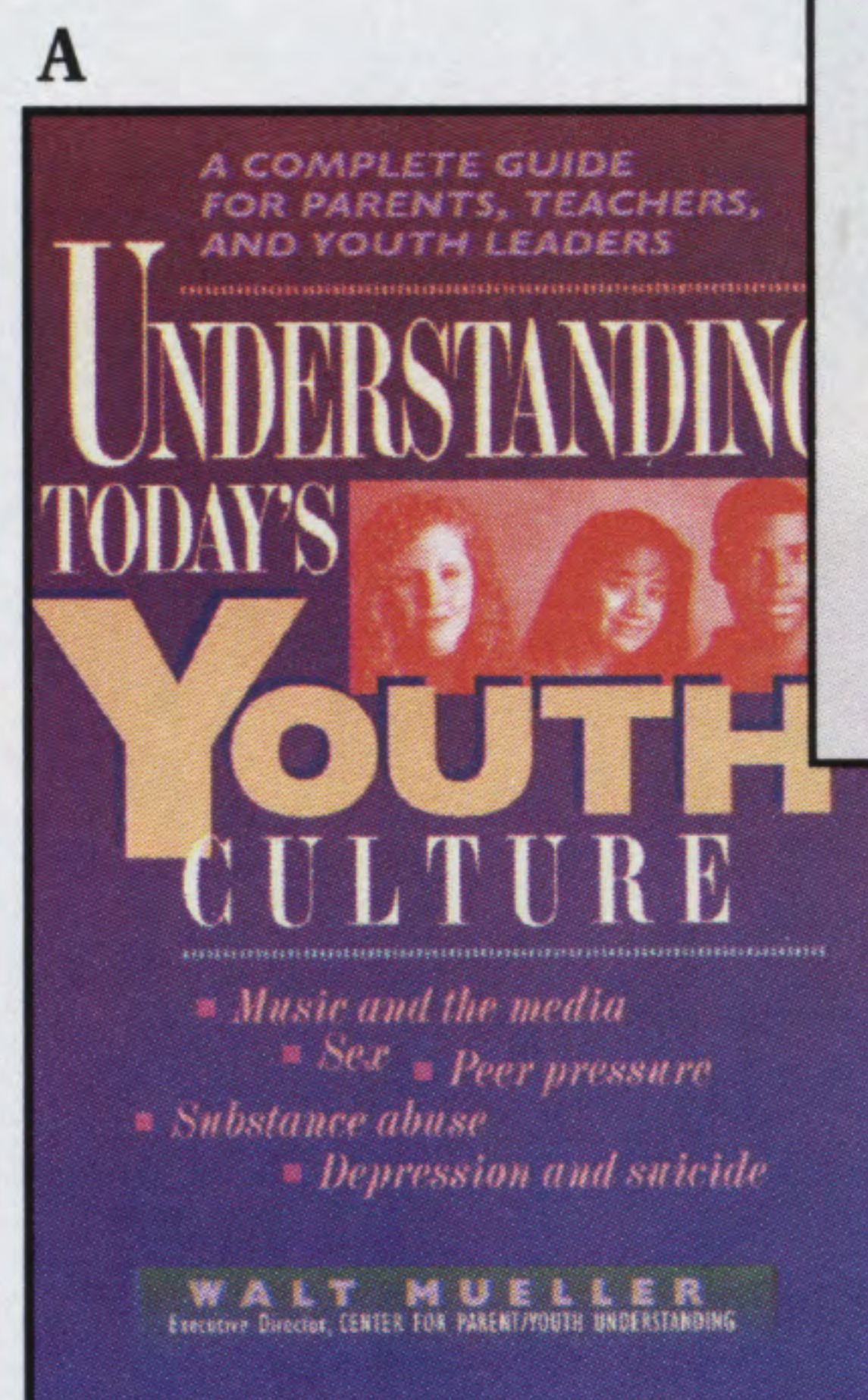

A. Understanding Today's Youth Culture by Walt Mueller. Clues leaders in to the confusing and often shocking world of today's teens. Looks at music, media, peer pressure, sex, substance abuse, and depression. Assures leaders that teens can be influenced before they fall into temptation. Includes subject index. Paper. 03MX2791 \$14.99

B. Color Thru the Old and New Testaments. 66 captivating cartoons teach the major concept of each Bible book. Kid-friendly language summarizes each book. 8 1/2 x 11" 72MX9114 \$10.95

C. Old Testament and New Testament Overhead Transparencies. Corresponds to *Color Thru the Old and New Testament*. Reinforces teaching of Bible books. Includes one color overhead for each book of the Bible and Old and New Testament teaching guides. 3-ring binder. 72MX9117 \$79.00

D. Old and New Testament Flash Cards. Miniature, colorful versions of Color Thru The Old and New Testaments. Designed for quizzing and individual practice. Cards are coated and come in a clear vinyl pouch. Card size 2 9/16 x 3 5/16" 72MX9121 \$12.00

E. The New Adventure Bible. Children's study Bible includes special sections about living the Christian life, interesting Bible history, Bible facts, and words to remember. Special features include book introductions written for children, 2 indexes, 15 color charts, 8 color maps, dictionary/concordance, and a presentation page. Ages 7-12. KJV, Hard 01MX0692 \$24.99
NIV, Hard 01MX0693 \$24.99

F. NirV Kids' Quest Study Bible. Combines the just-for-kids NirV Bible with the Questions Kids Ask series. Contains more than 500 illustrated questions and answers woven through this easy-to-read Bible. Includes book introductions and dictionary. Ages 6-10. Paper. 01MX0153 \$24.99

G. Pacesetters by Benny Perez. Offers a bold challenge for believers to get passionate about living for God. Get off and running with chapters on bucking the trends and setting the pace. Learn from Bible characters like Isaiah and Uzziah how to do it right—or keep from getting off track. Then finish strong with the passion and pulse of a pacesetter. Paper. 03MX6454 \$10.00

H. More Great Fundraising Ideas for Youth Groups by David and Kathy Lynn. More than 150 fundraising pointers, including: More Food 'n' Fun, Sales and So Forth, Beyond Babysitting and Lawn Mowing, Sports Stuff, Pennies from Heaven, and Gonzo Fundraisers. Also summarizes some fundraising policy ideas and perpetual gifts. Paper. 03MX6157 \$12.99

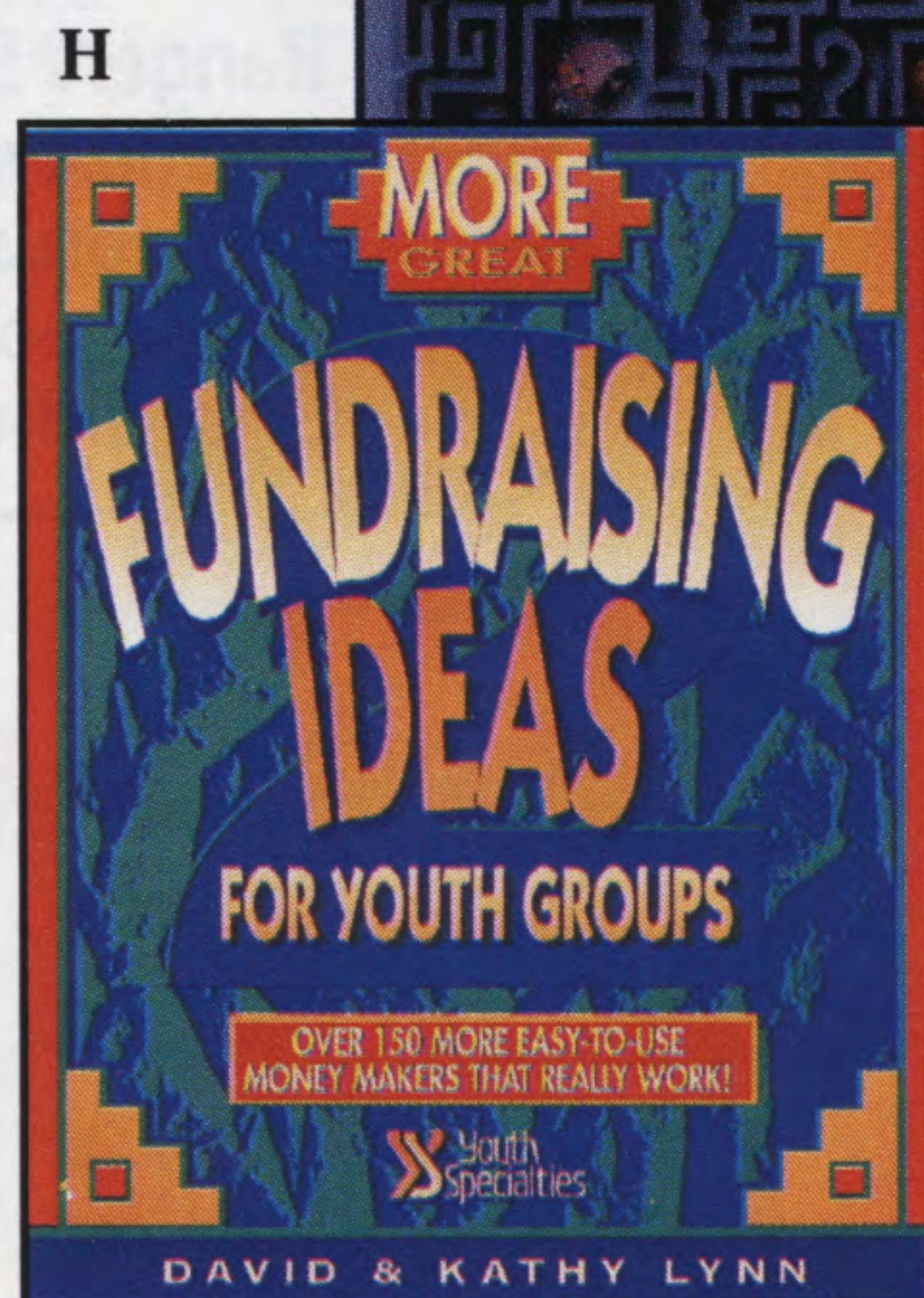
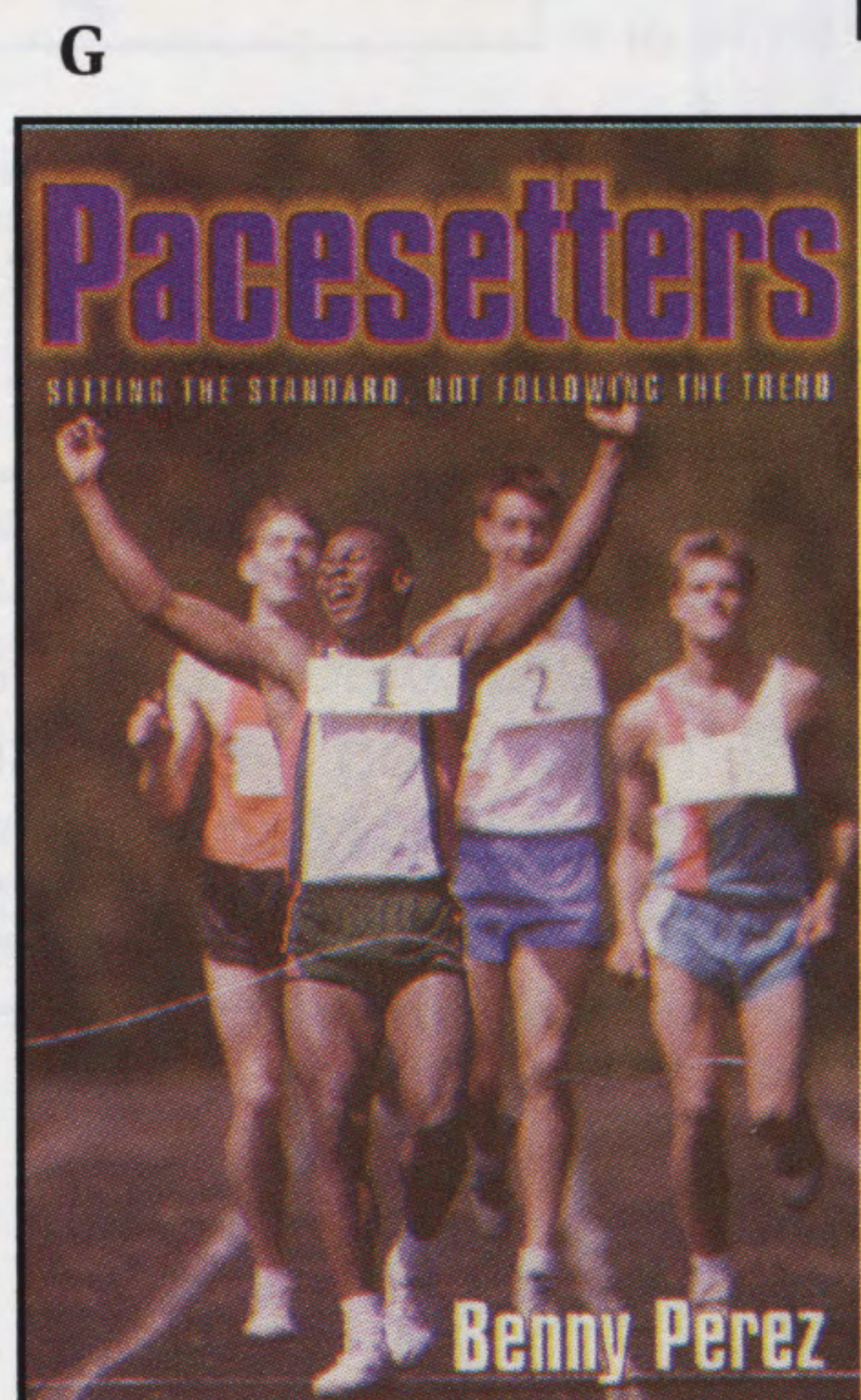
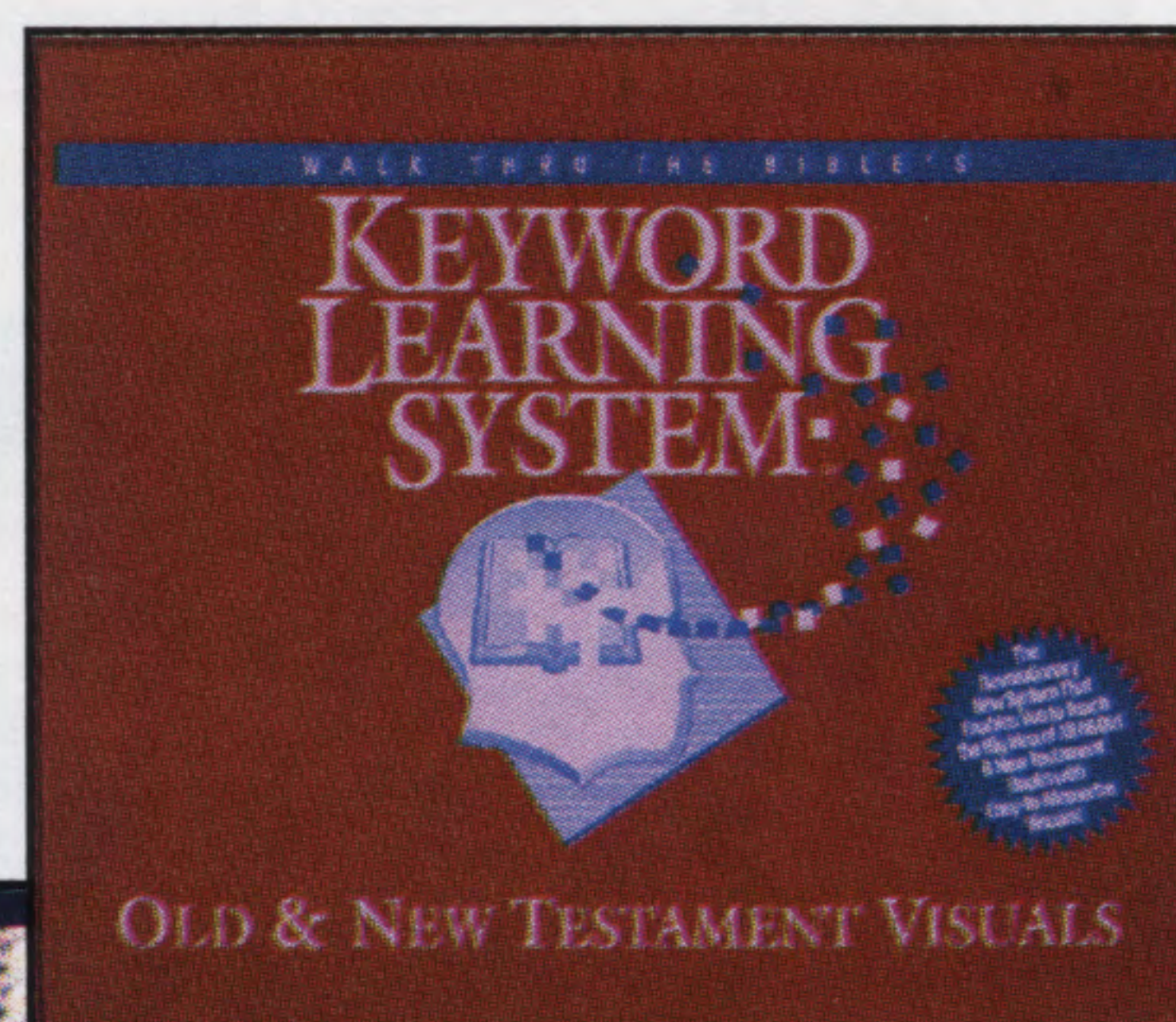
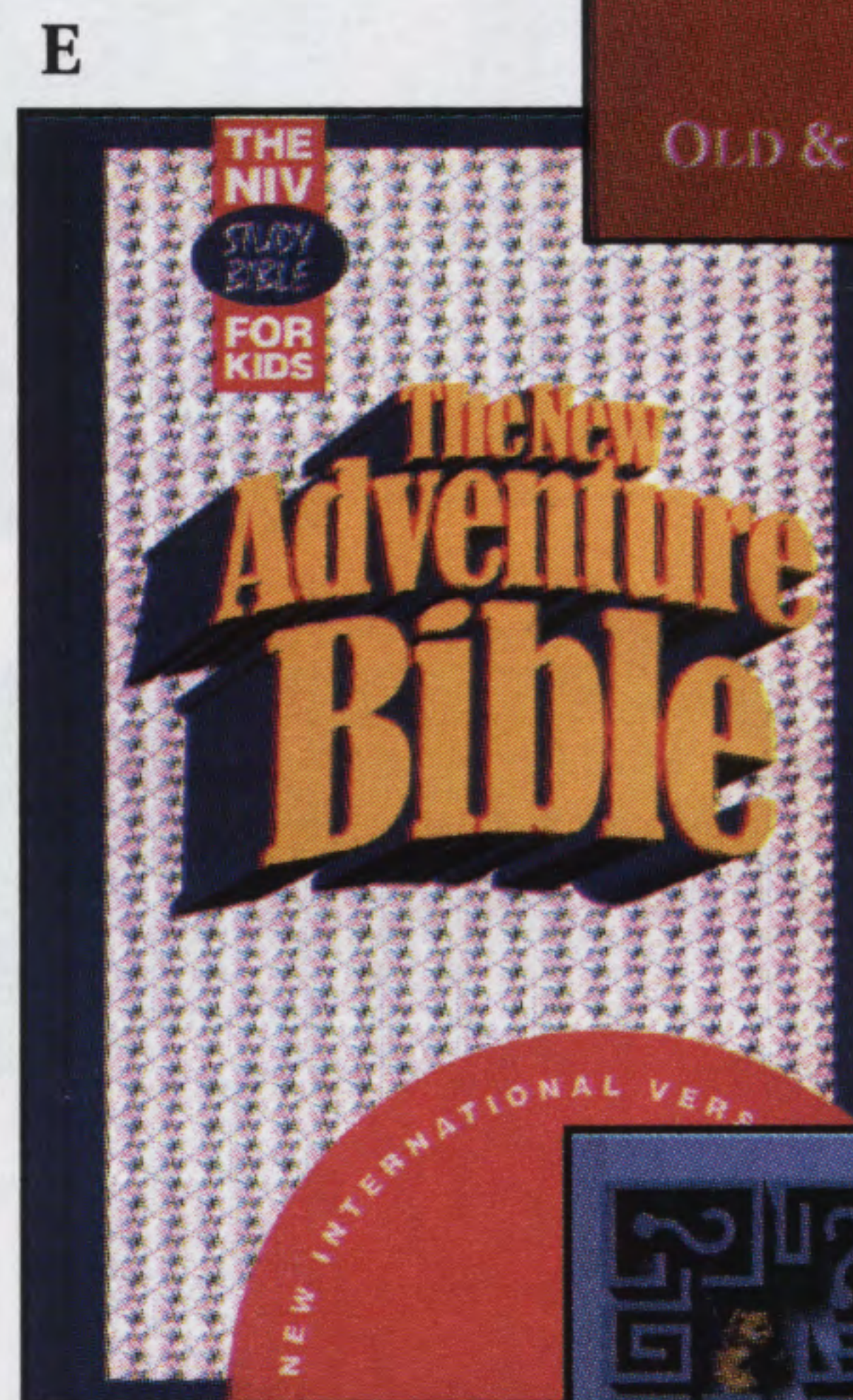
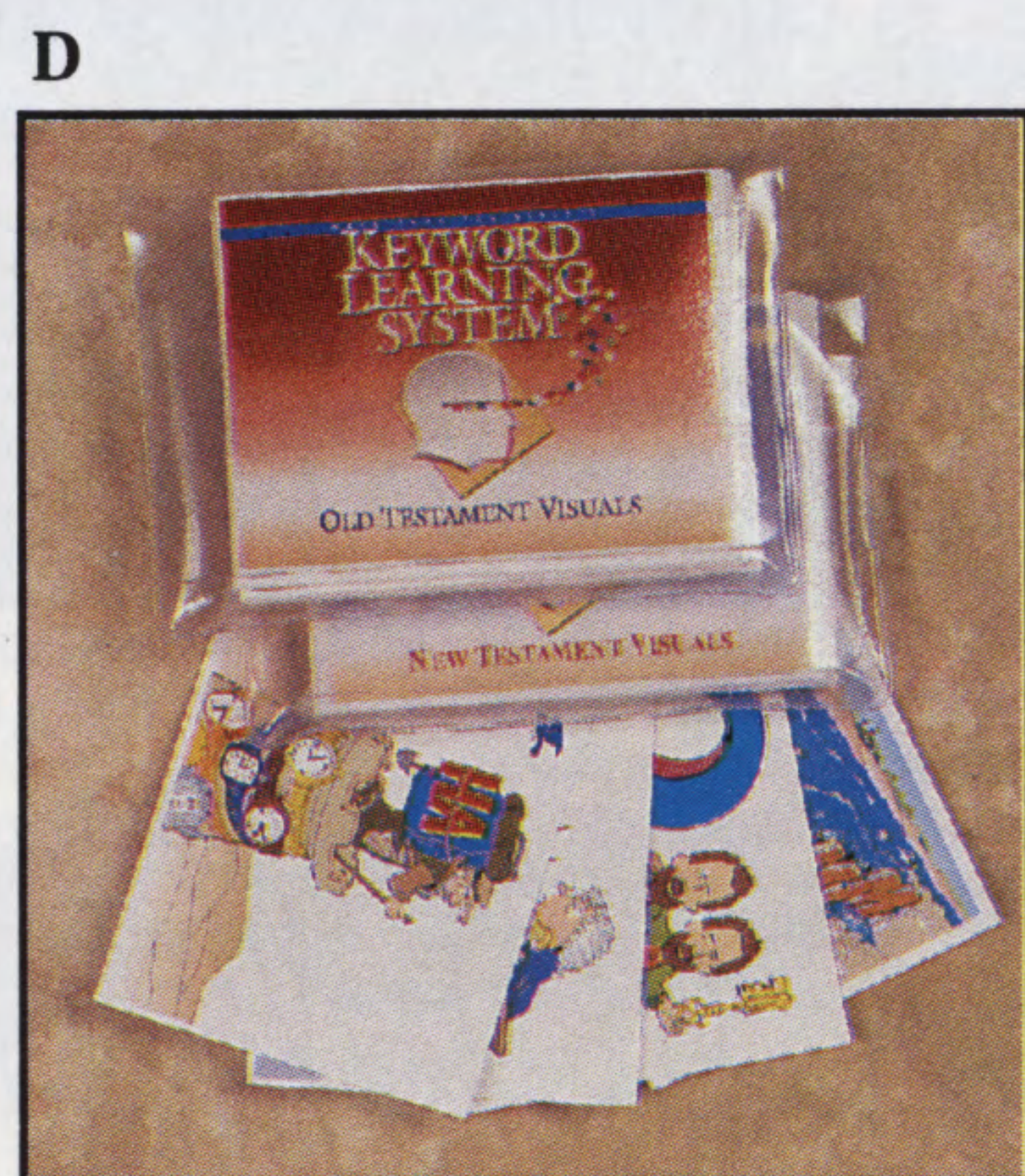

A. Jesus, The Holy Spirit, and Me: Coloring Book. Easy-to-color illustrations and easy-to-read Bible verses teach children about Salvation, the Holy Spirit, Healing, and the Second Coming. Ages 2-7. Paper. 02MX0760 \$1.50

B. Jesus, The Holy Spirit, and Me: Activity Book. Filled with fun, faith-building activities to help children learn more about God's Word. Scripture verses and activities focus on 4 Bible truths: Salvation, the Holy Spirit, Healing, and the Second Coming. Ages 8-11. Paper 02MX0761 \$1.50

C. The Young Christian's Puzzle Book: For Becoming a Grown-Up Christian by Linda Faulkner. Fun workbook featuring crossword puzzles, codes, fill-in-the-blanks, and other activities. Activities are designed to help young Christians learn how to use their Bibles, grasp the meanings of basic Christian terms, and learn about the Trinity. Paper. 02MX0828 \$3.50

D. What's Next? New Life in Christ Guidebook for Children. Booklet with sound guidelines for children to follow immediately after their salvation experience. Paper. 02MX0559 69¢ ea.; 12-99, 59¢ ea.; 100 or more, 55¢ ea.

E. Thumbs Up Football Game Set. Paper football with a 90's twist! A simple flick of the fingers and these aerodynamic game pieces soar across the game board. It's great for indoor meetings or round robin tournaments. Gameboard unfolds to 20 x 35". Ages 5 and up.

Game Set 1. Comes with 1 playing board, 1 Sidekick™ playing piece, 8 Trophy Kicks™, and 1 score sheet. 72MX9302 \$15.99

Game Set 2. Comes with 3 playing boards, 3 Sidekick™ playing pieces, 24 Trophy Kicks™, and 3 score sheets. 72MX9303 \$39.95

12 Piece Set. Assorted set of 12 Sidekicks™ and 60 Trophy Kicks™. 72MX9300 \$35.95

24 Piece Set. Assorted set of 24 Sidekicks™ and 120 Trophy Kicks™. 72MX9301 \$69.95

F. Clip and Tell Some More Bible Stories. Contains 24 faith-building stories to help children follow God. Complete instructions and reproducible patterns make storytelling easy. Paper. 03MX5218 \$14.99

G. Instant Group Devotions for Children's Ministry. Includes 54 quick-preparation, ready-to-go devotions for children. Devotions are Bible based and last 5-10 minutes. Paper. 03MX5833 \$12.99

H. More Than Mud Pies. 48 crafts and games that reinforce Bible truths; develop children's language, thinking, and counting skills; and build confidence. Each activity comes with reproducible instructions to send home so parents can participate in the fun. Paper. 03MX6184 \$14.99

I. All Star Games from All Star Youth Leader. Contains a mix of icebreakers, mixers, cooperative and competitive games, off-the-wall games, and games that make a point from some of America's leading youth workers. 03MX5048 \$12.99

J. Power Pak of Games. More than 100 games divided into 8 categories: Water games, action, food and drink, hide and seek, relay, strength and skill, toss and throw, and guessing. Prop lists and complete instructions. Paper. 03MX3541 \$11.95

K. Slam Dunk AIDS Comic Book. Bright, contemporary design and story teach children and youth of the dangers of AIDS. Sports-hero theme captures attention and presents the facts about AIDS and a salvation message. A great tool for youth outreach and AIDS education. Space available on back for church imprint. 16 pages. Paper. 02MX1096 49¢ ea.; 50-99, 35¢ ea.; 100 or more, 25¢ ea.

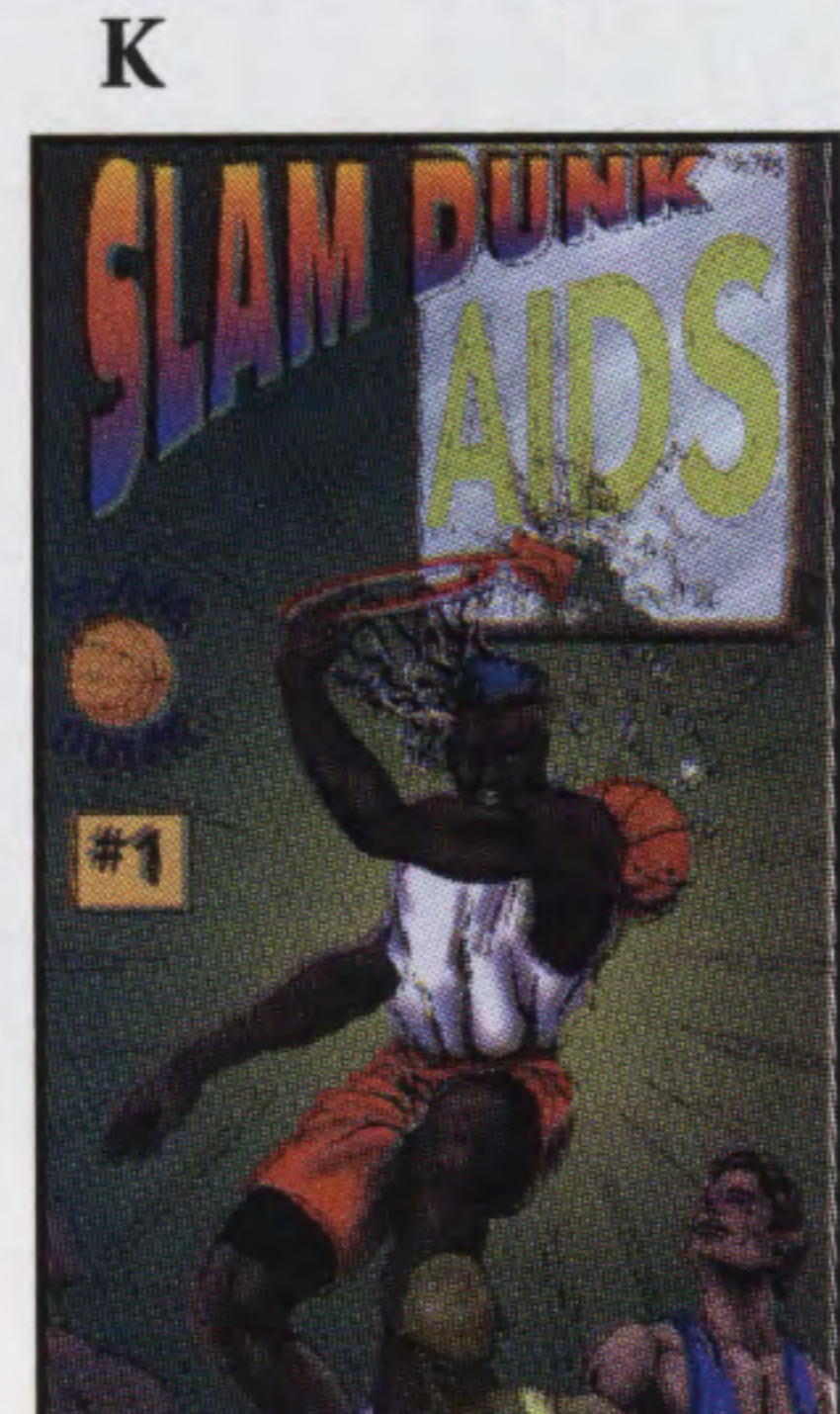
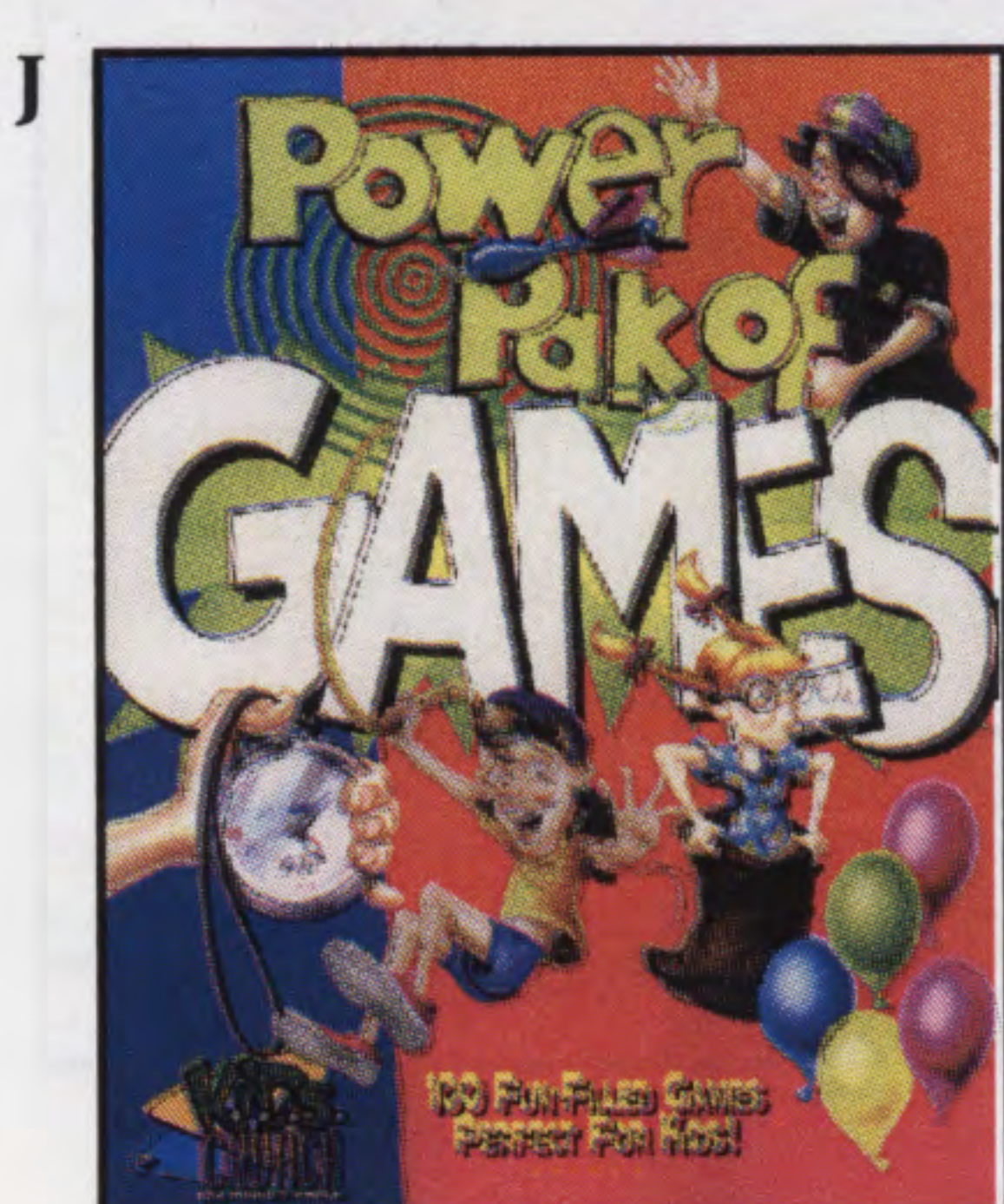
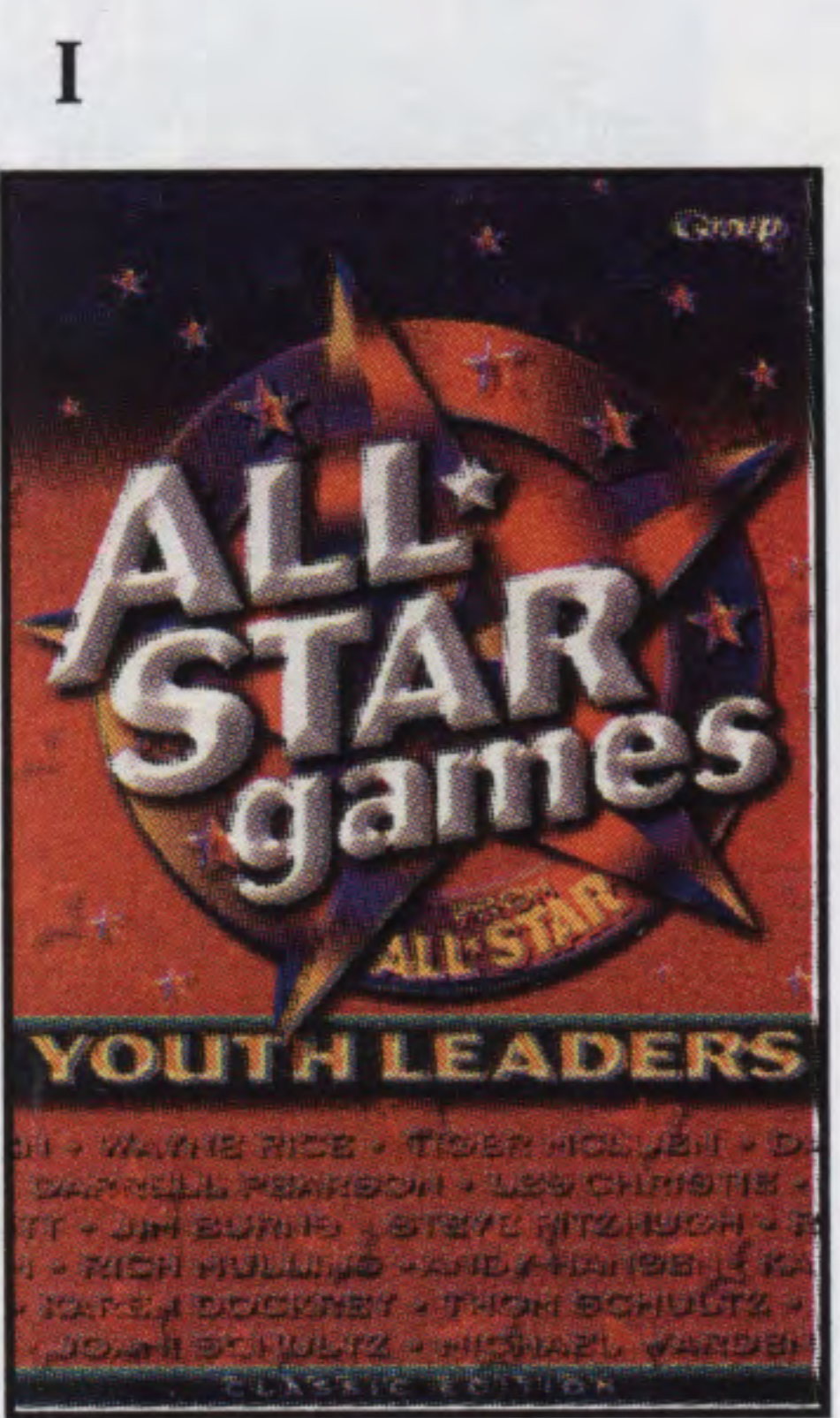
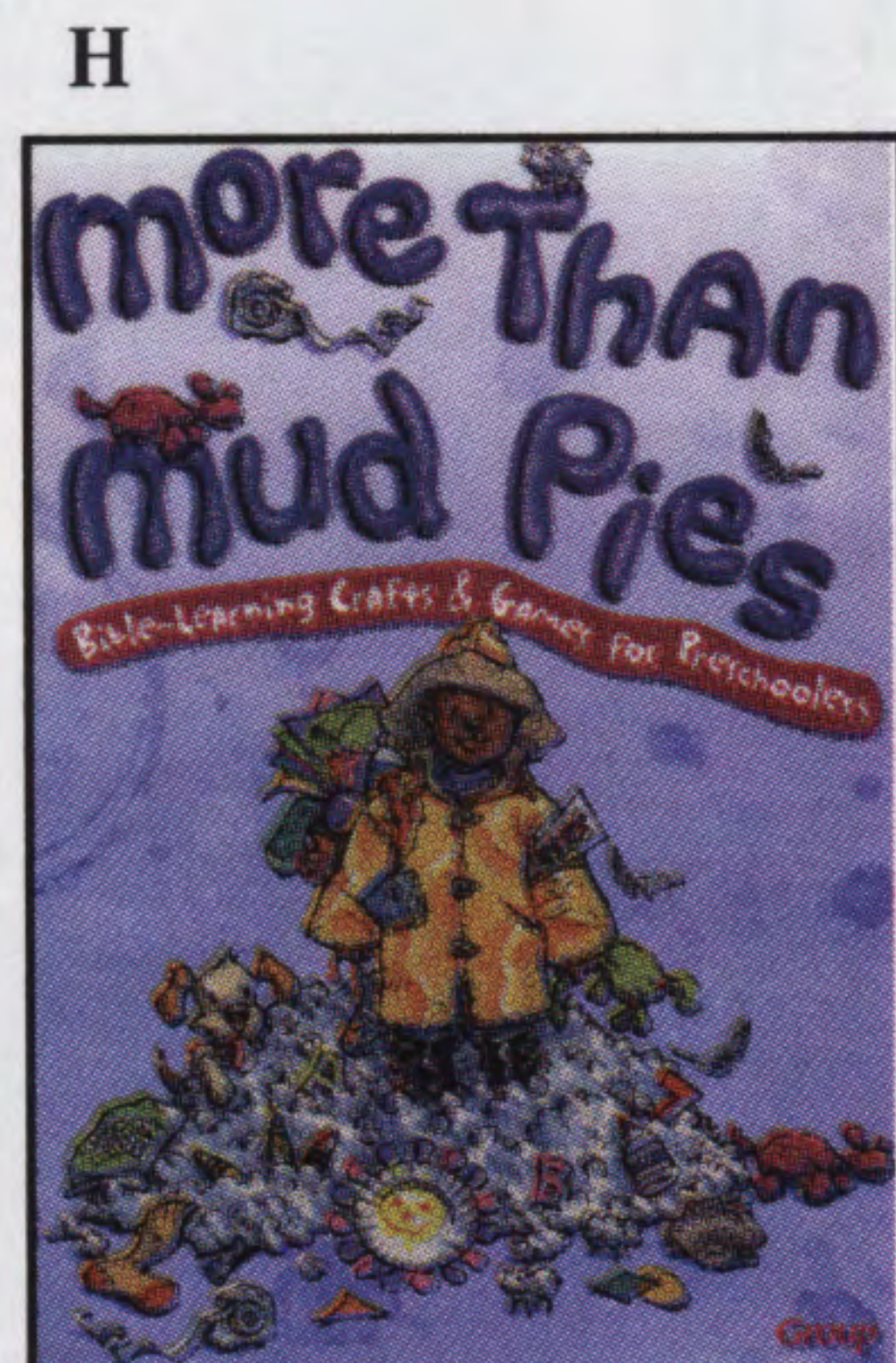
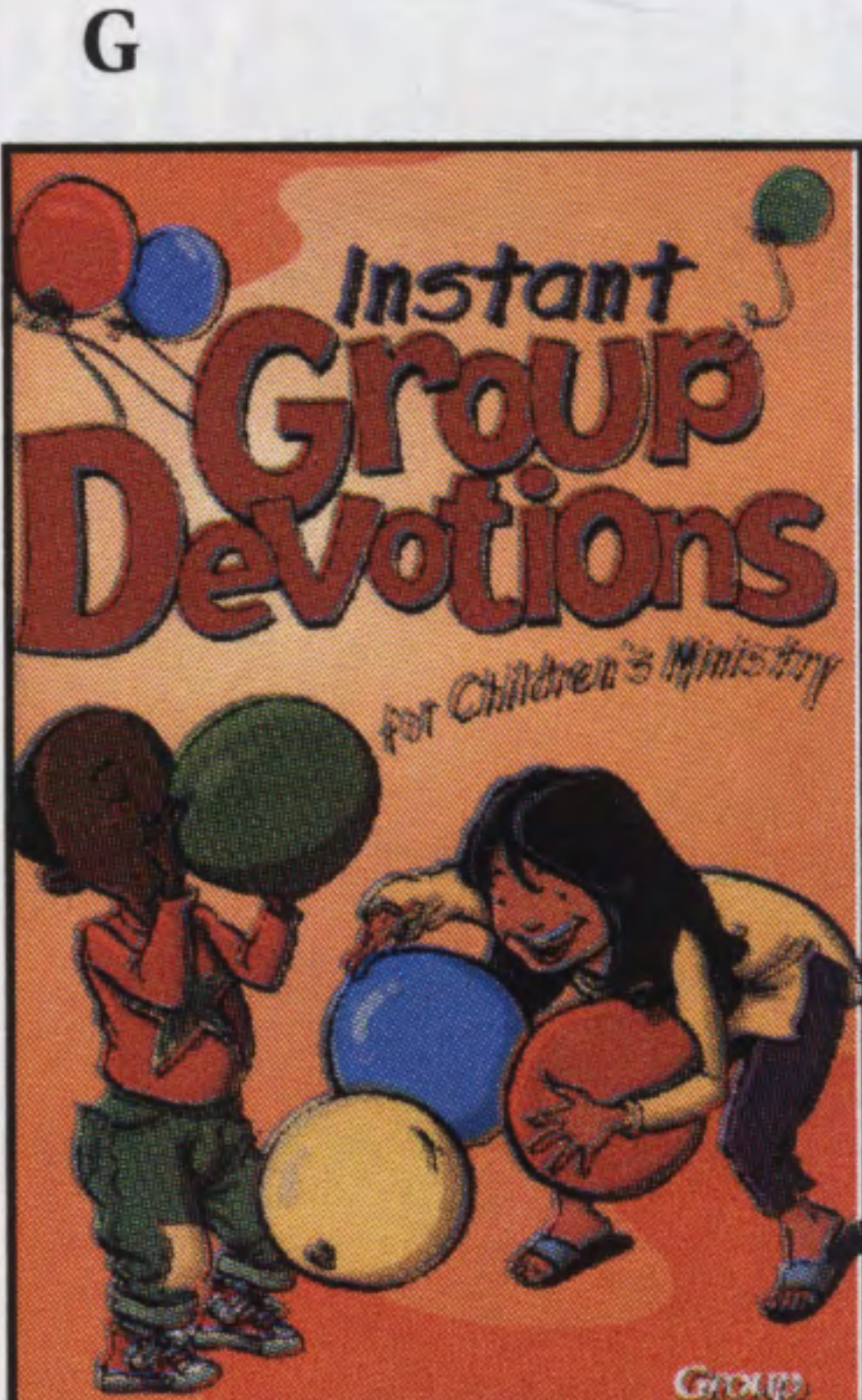
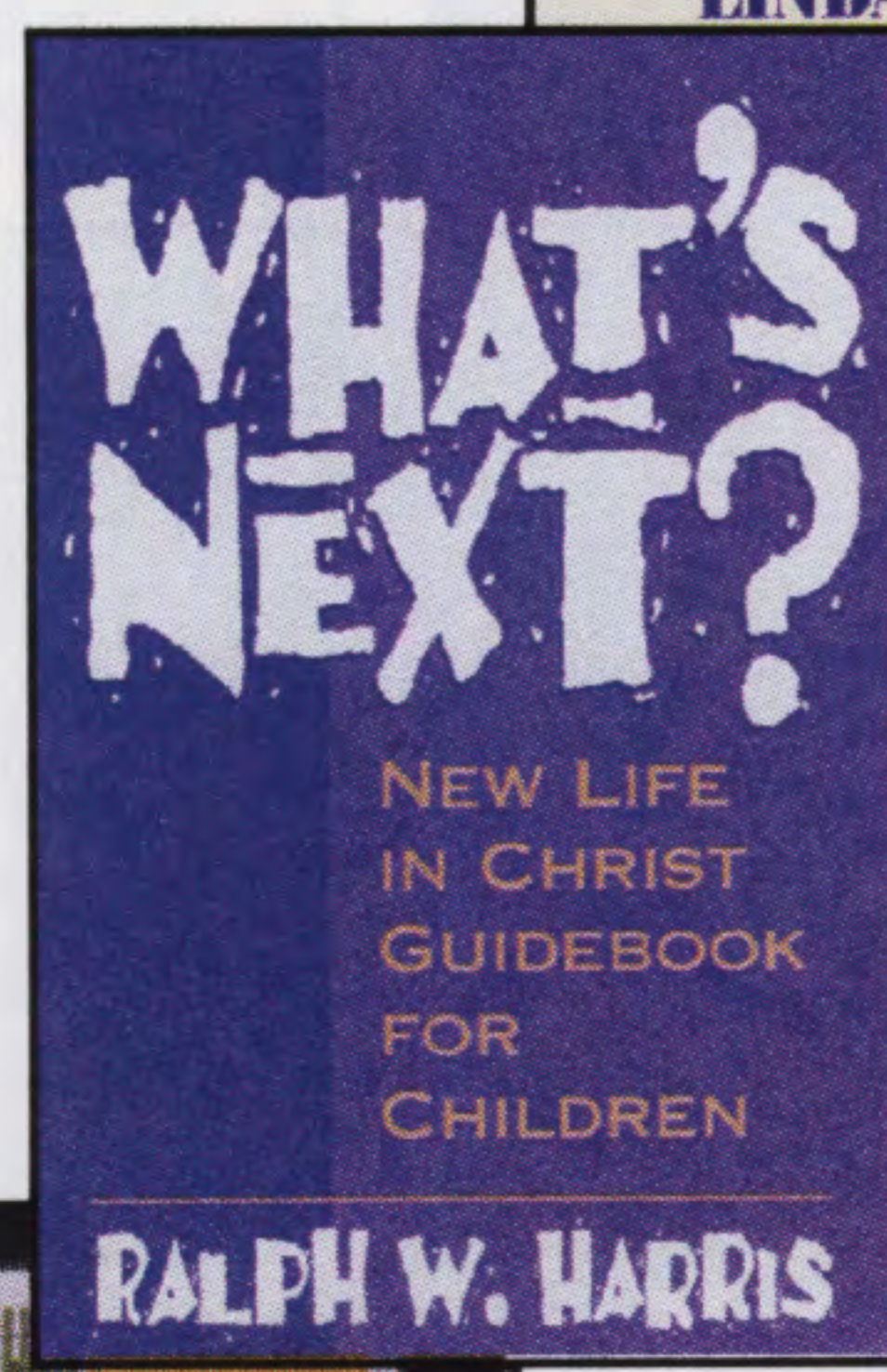
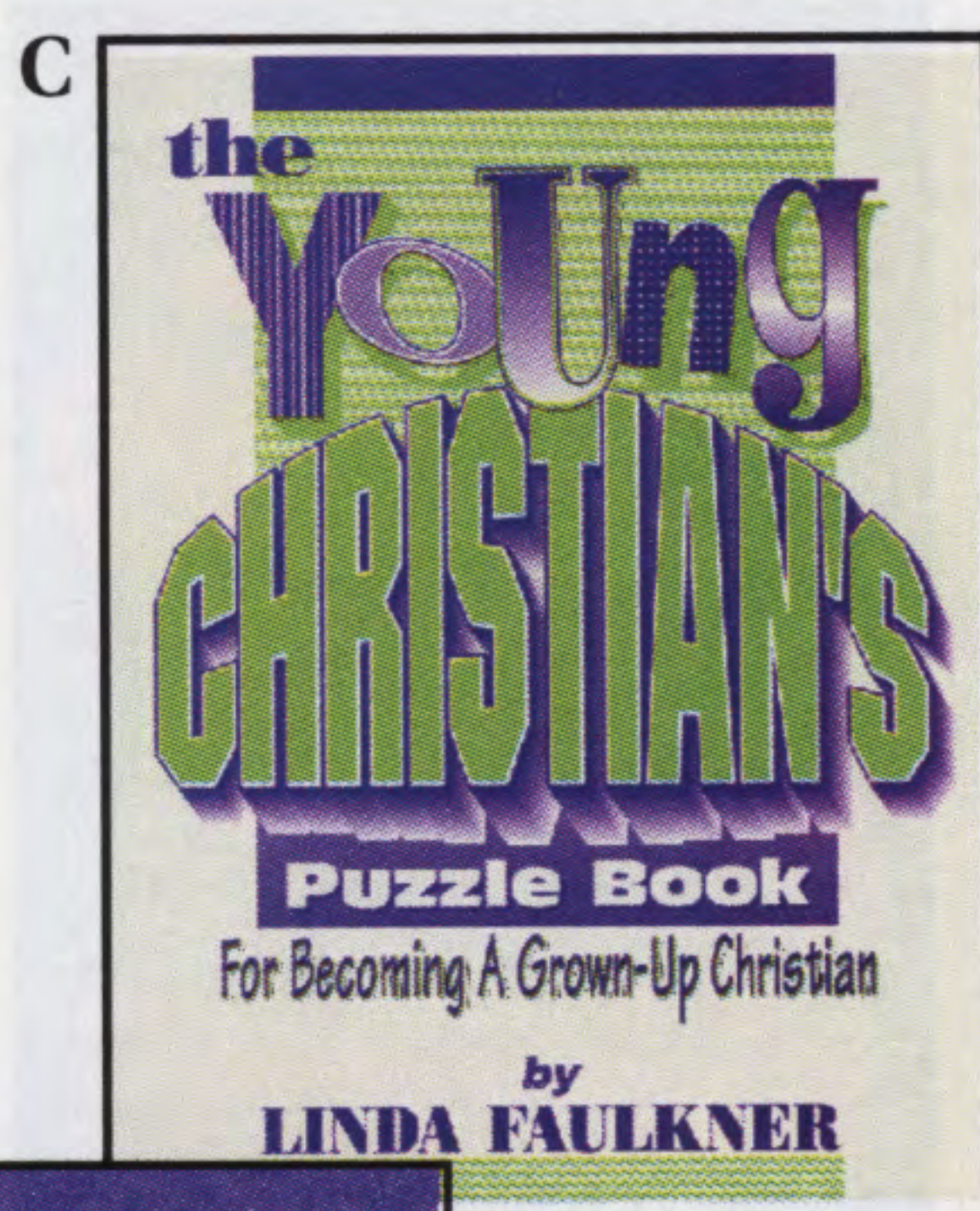
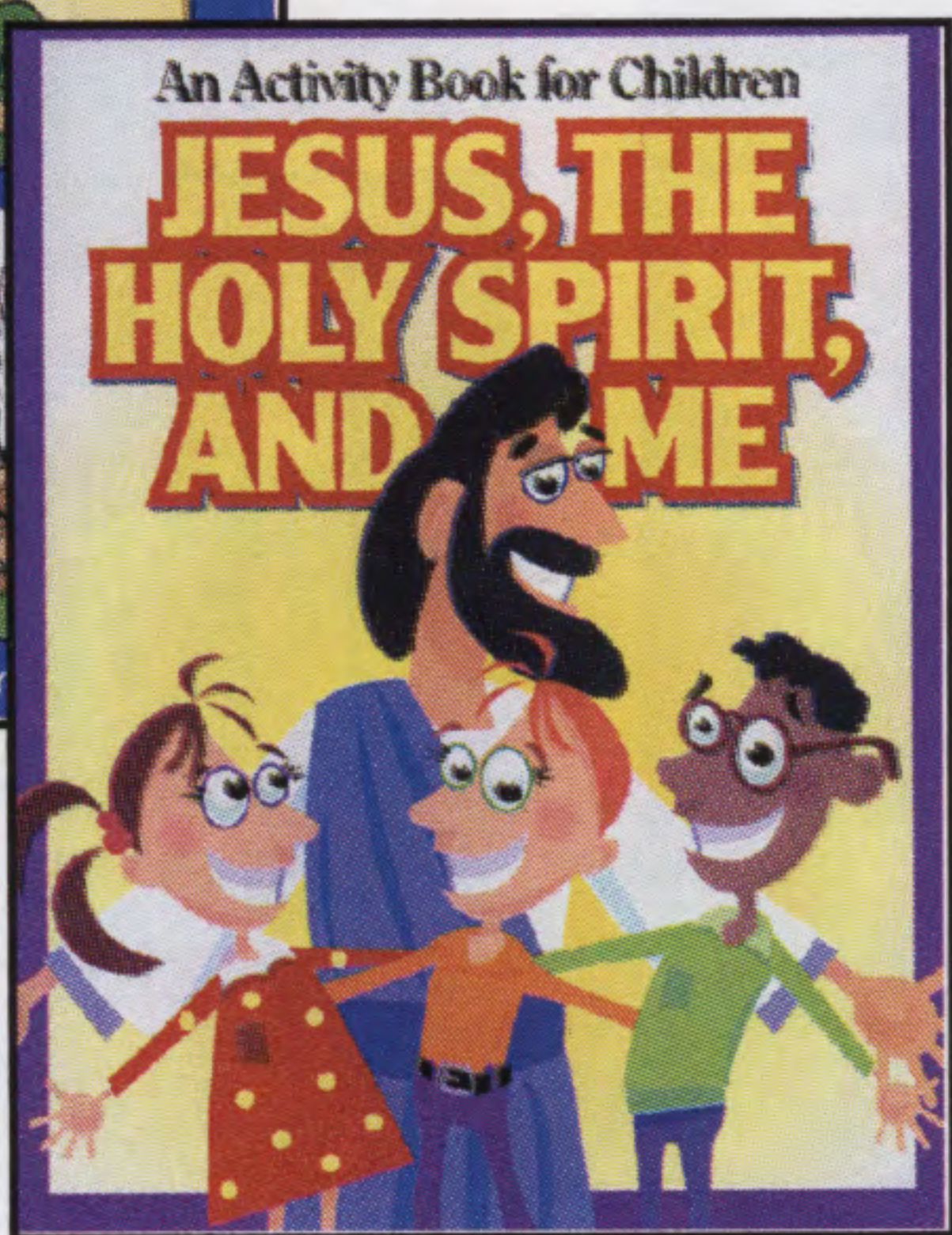

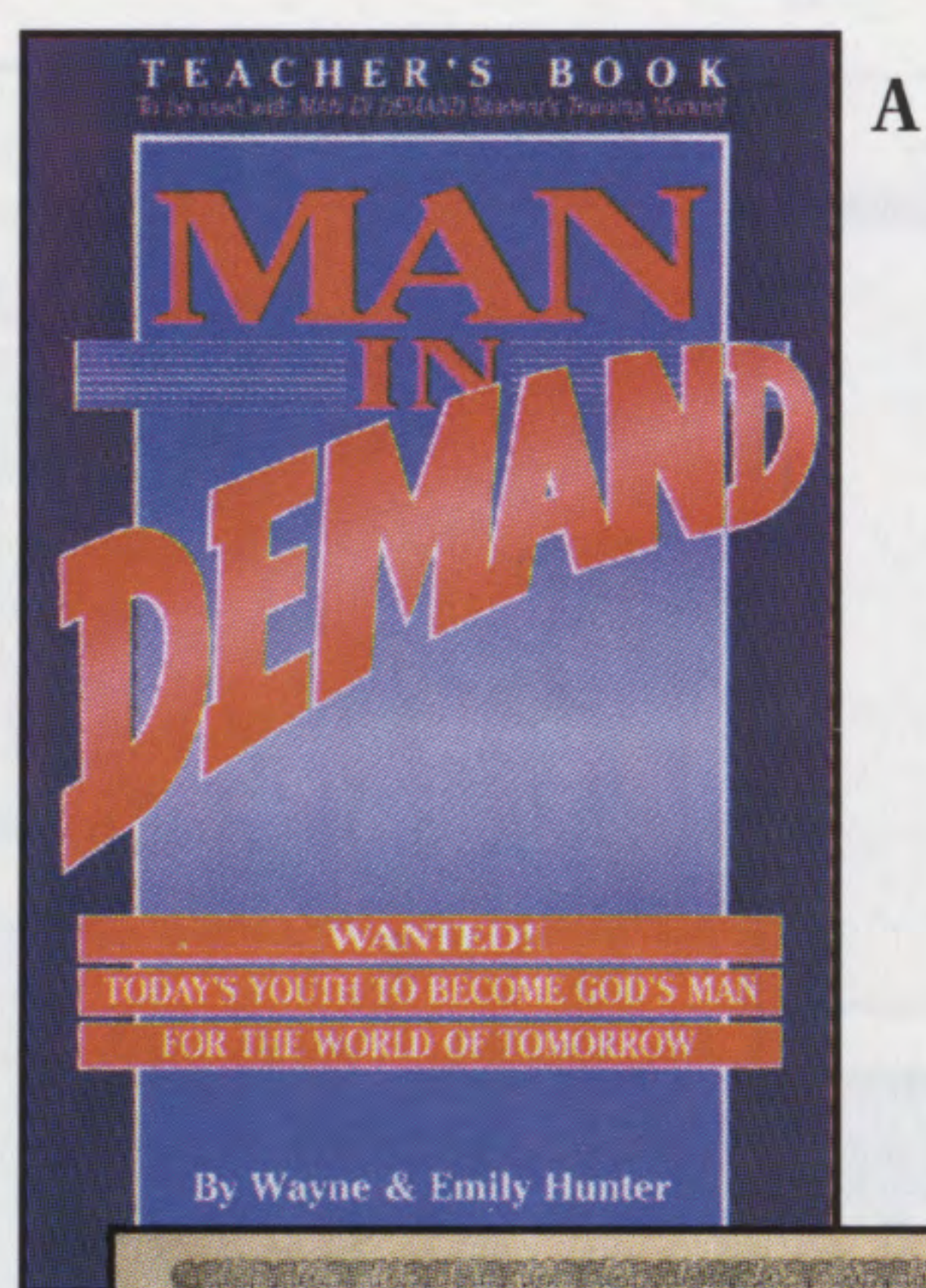

A

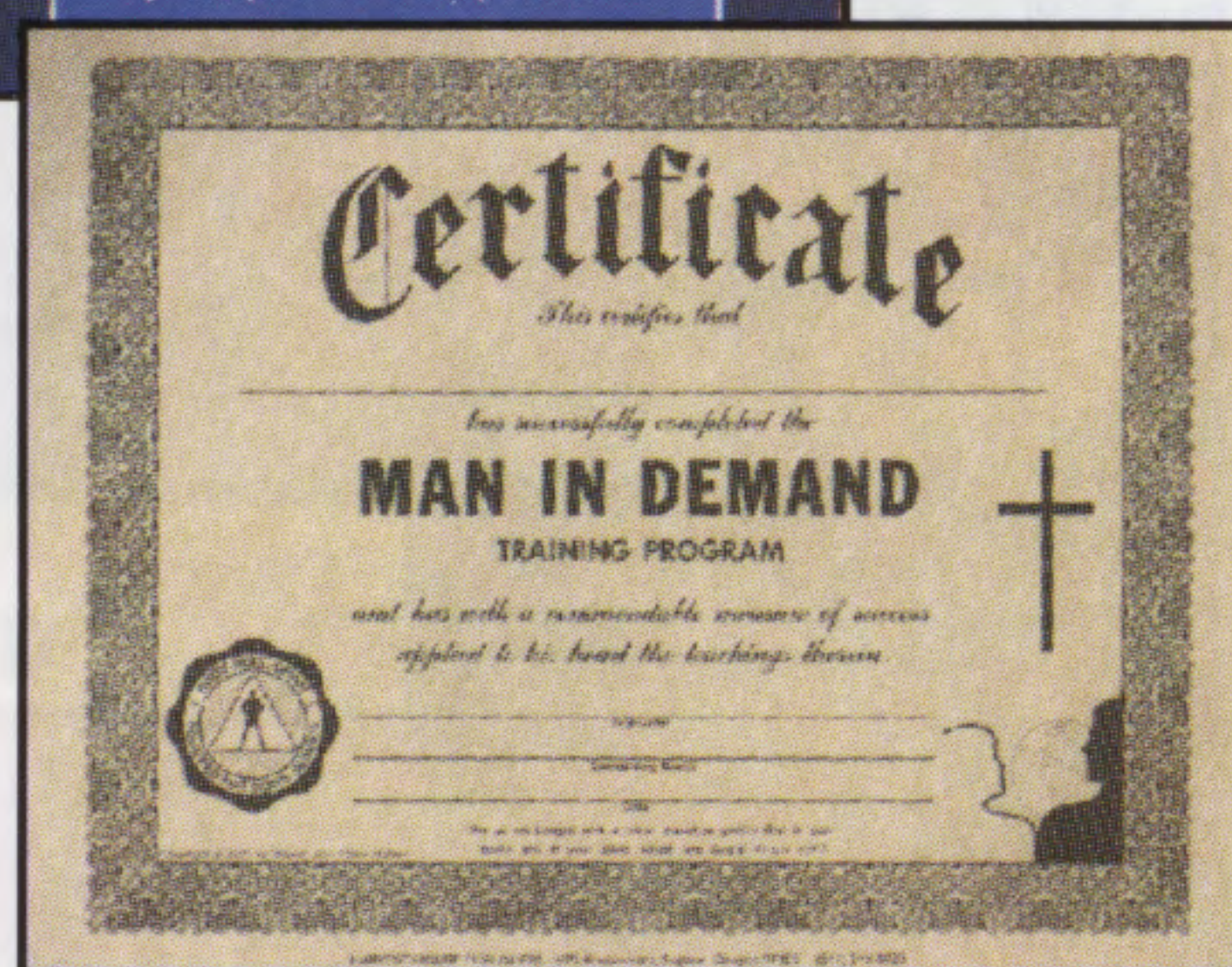

B

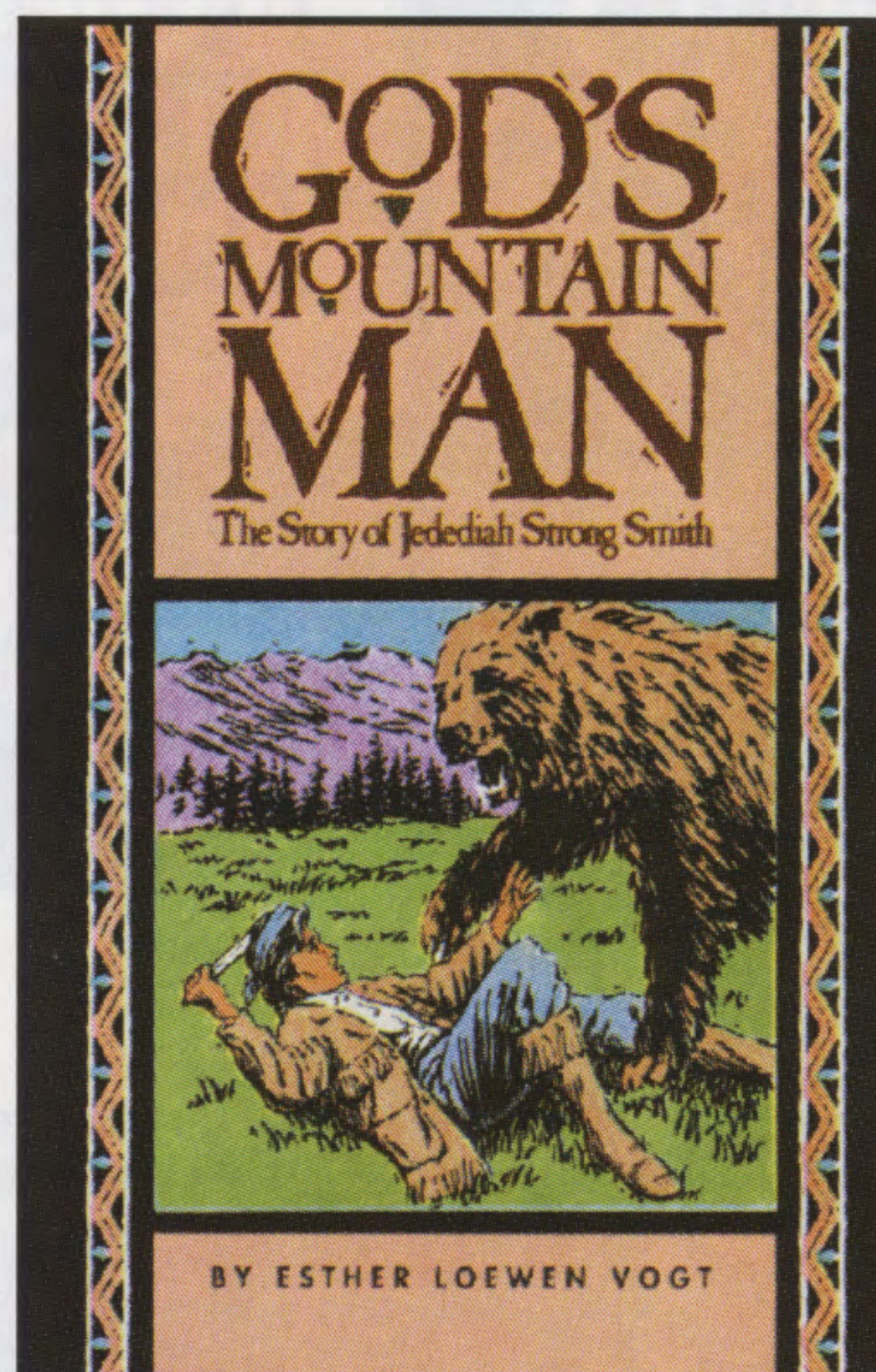

C

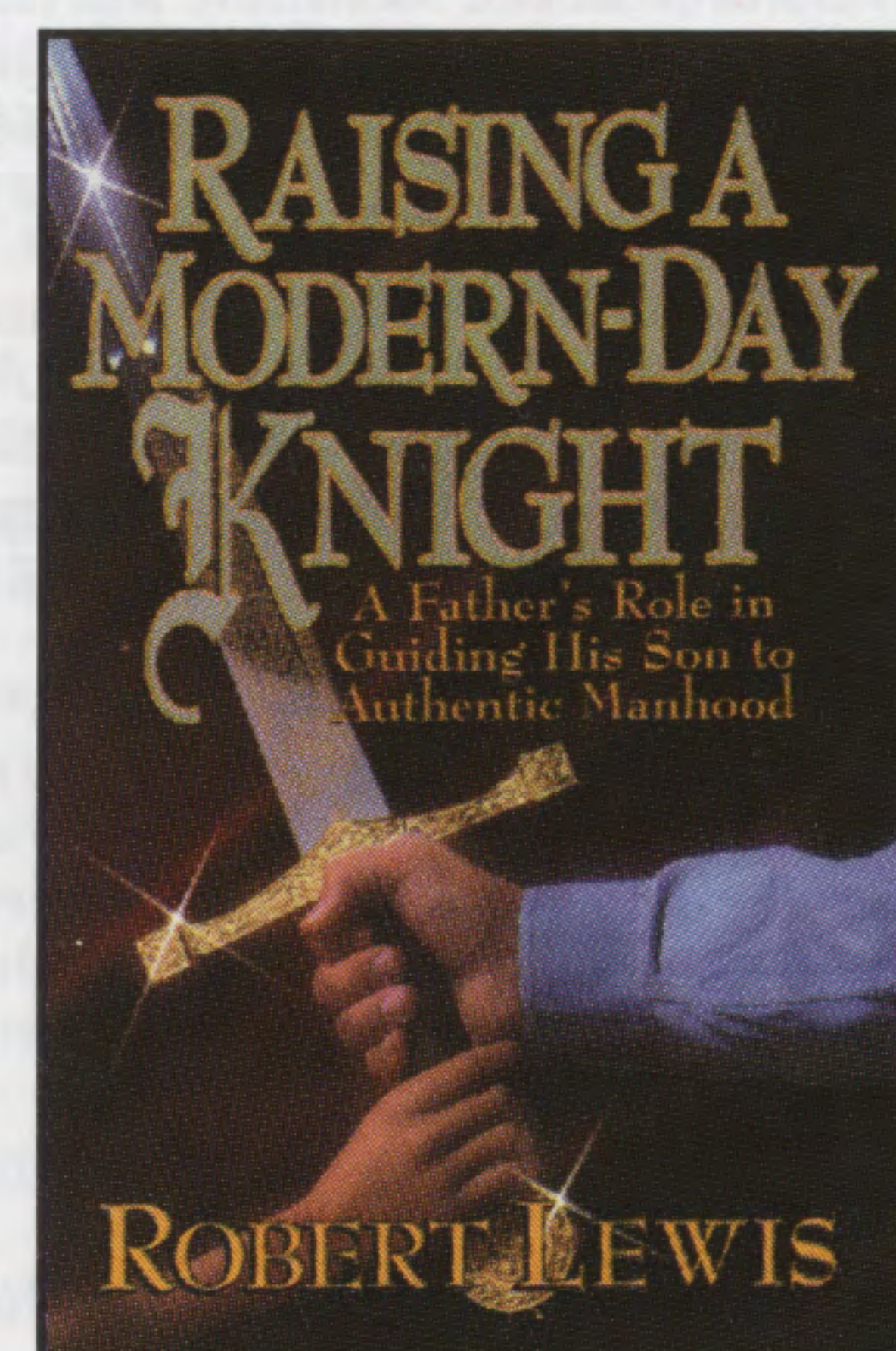

A. Man in Demand. A training program for boys that is practical, inspirational, and life-changing. Offers step-by-step instruction to meet the challenge of dynamic Christian leadership in tomorrow's world. Subjects include: Personal identity, conversational skills, physical and spiritual fitness, grooming, sexuality, clothes, dating, Christian character, and more. Paper.

| | | |
|-------------------------|----------|--------|
| Student Training Manual | 03MX3283 | \$7.99 |
| Teacher's Book | 03MX3282 | \$9.99 |
| Certificate | 06MX5111 | 50¢ |

B. God's Mountain Man: The Story of Jedediah Strong Smith by Esther Loewen Vogt. Adventure-filled biography of pioneer Jed Smith who remained faithful to God as he explored America's early West. An exciting, fast-paced story tells of treacherous river crossings, fighting Indians, battling a fierce grizzly, and survival. Paper. 02MX0563 \$5.95

C. Raising A Modern-Day Knight by Robert Lewis. Uses an analogy from medieval times to train sons with a masculine vision, code of conduct, and a cause. Offers practical advice, specific tools, and ideas to help you raise your own son. Hard.

| | | |
|----------------|----------|---------|
| | 03MX6500 | \$16.99 |
| Audio Cassette | 28MX0735 | \$15.99 |

D. The Incredible Power of Prayer. Motivate believers to pray with this 4-part video series highlighting the impact of prayer in America's history. Observe specific prayer interventions and watch dramatic re-enactments. Each video comes with an interactive study guide for group application.

| | | |
|------------------------------|----------|---------|
| Vol. 1: The Power of Prayer | 28MX0990 | \$19.99 |
| Vol. 2: In God We Trust | 28MX0991 | \$19.99 |
| Vol. 3: Miraculous Answers | 28MX0992 | \$19.99 |
| Vol. 4: One Nation Under God | 28MX0993 | \$19.99 |
| 4-Volume Set | 28MX0994 | \$74.99 |

E. The Youth Worker's Encyclopedia of Bible-Teaching Ideas compiled by Mike Nappa and Michael Warden. More than 365 new and creative teaching ideas—learning games, creative readings, object lessons, music ideas, party themes, retreats, skits, prayers, group projects, and more. One or more activities for each book of the Bible. Includes Scripture, theme, and teaching-style indexes.

| | |
|---------------|--------------|
| Old Testament | 03MX2936 |
| New Testament | 03MX2939 |
| | \$19.99 each |

F. Teaching Teenagers to Pray by Michael Warden. Rejuvenate teens with a 4-session study that introduces them to main aspects of prayer: What is prayer?, private prayer, team prayer, and corporate prayer. Hands-on learning activities increase retention as teens get to experience each session—not just "hear" it. Paper. 03MX2713 \$11.99

D

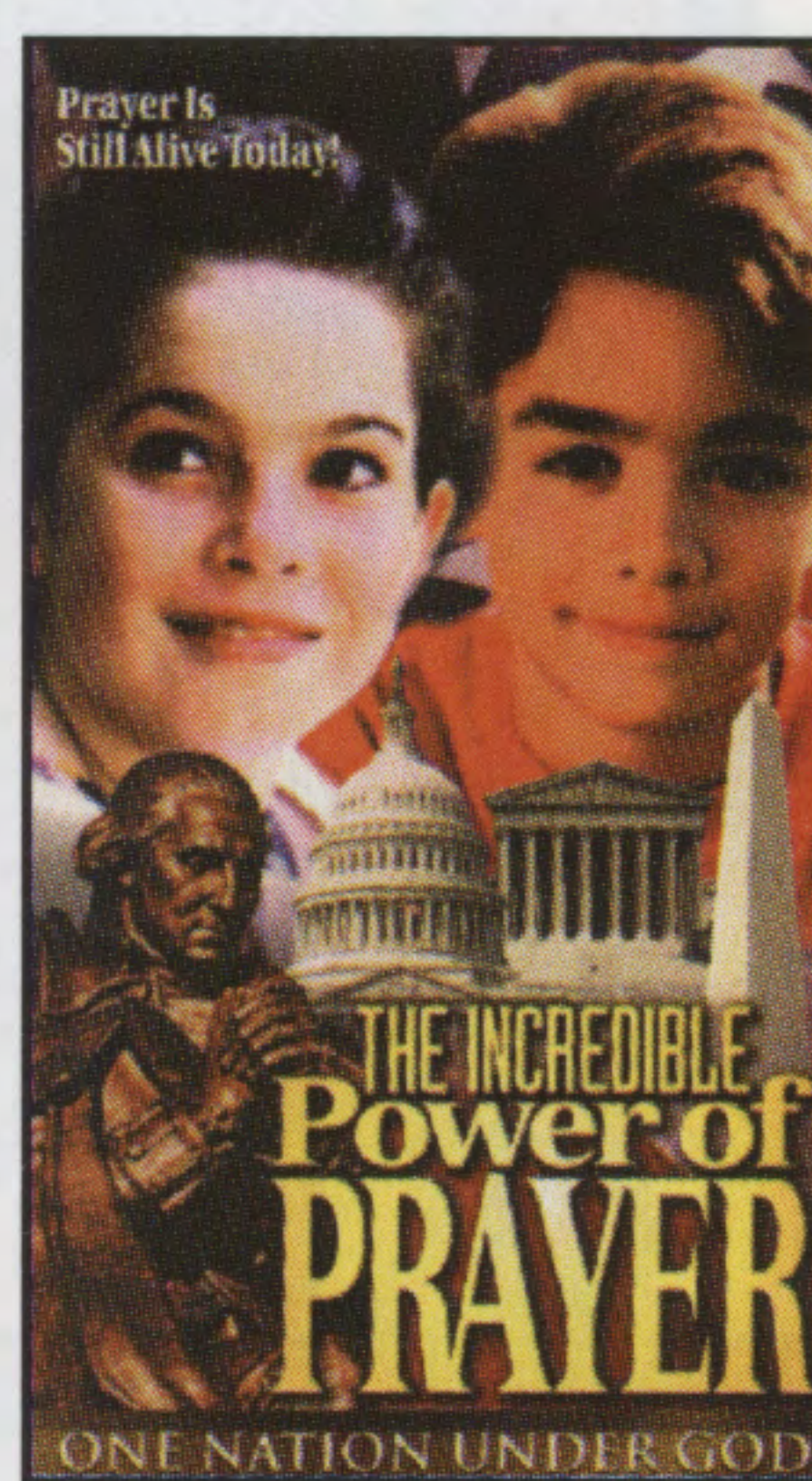
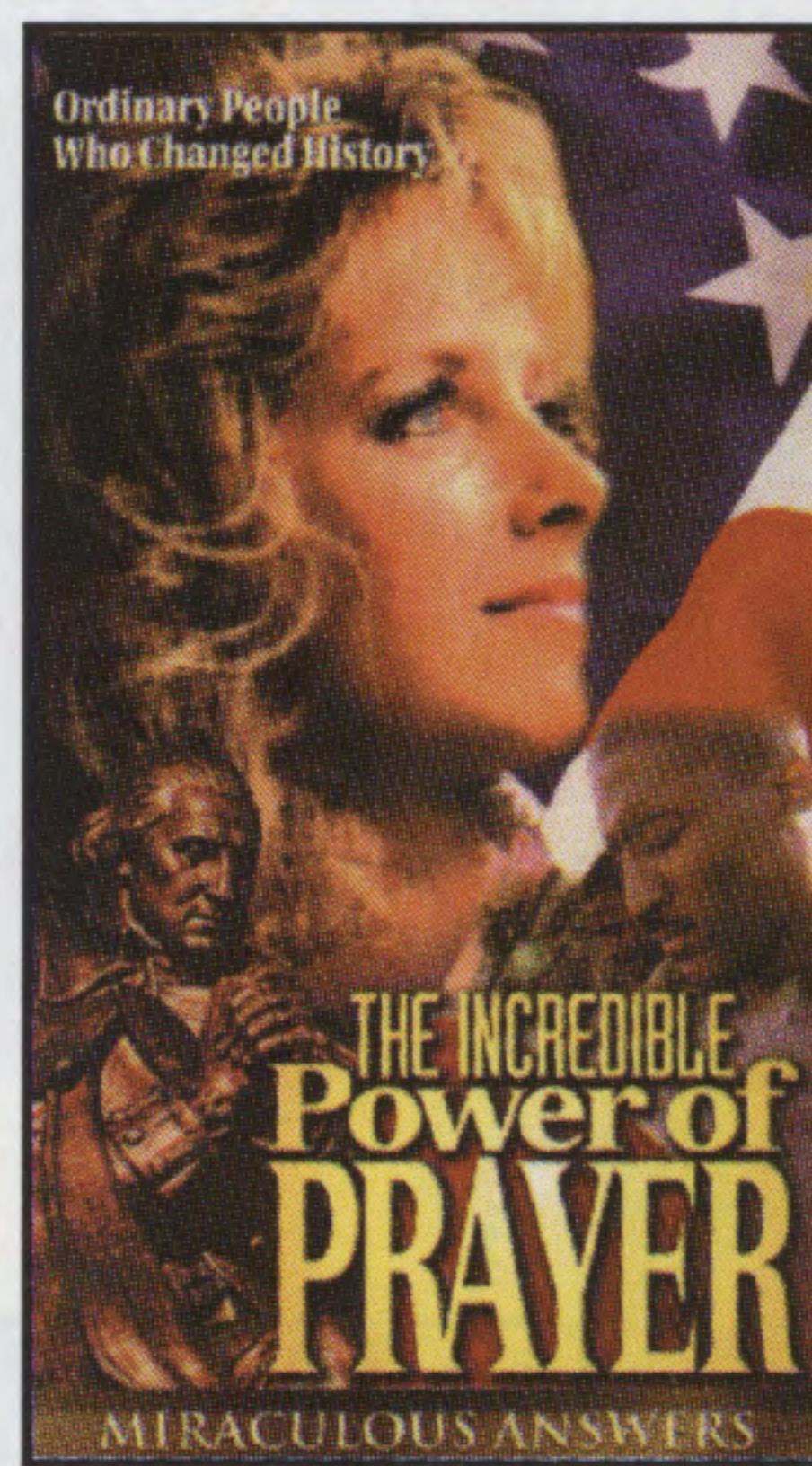
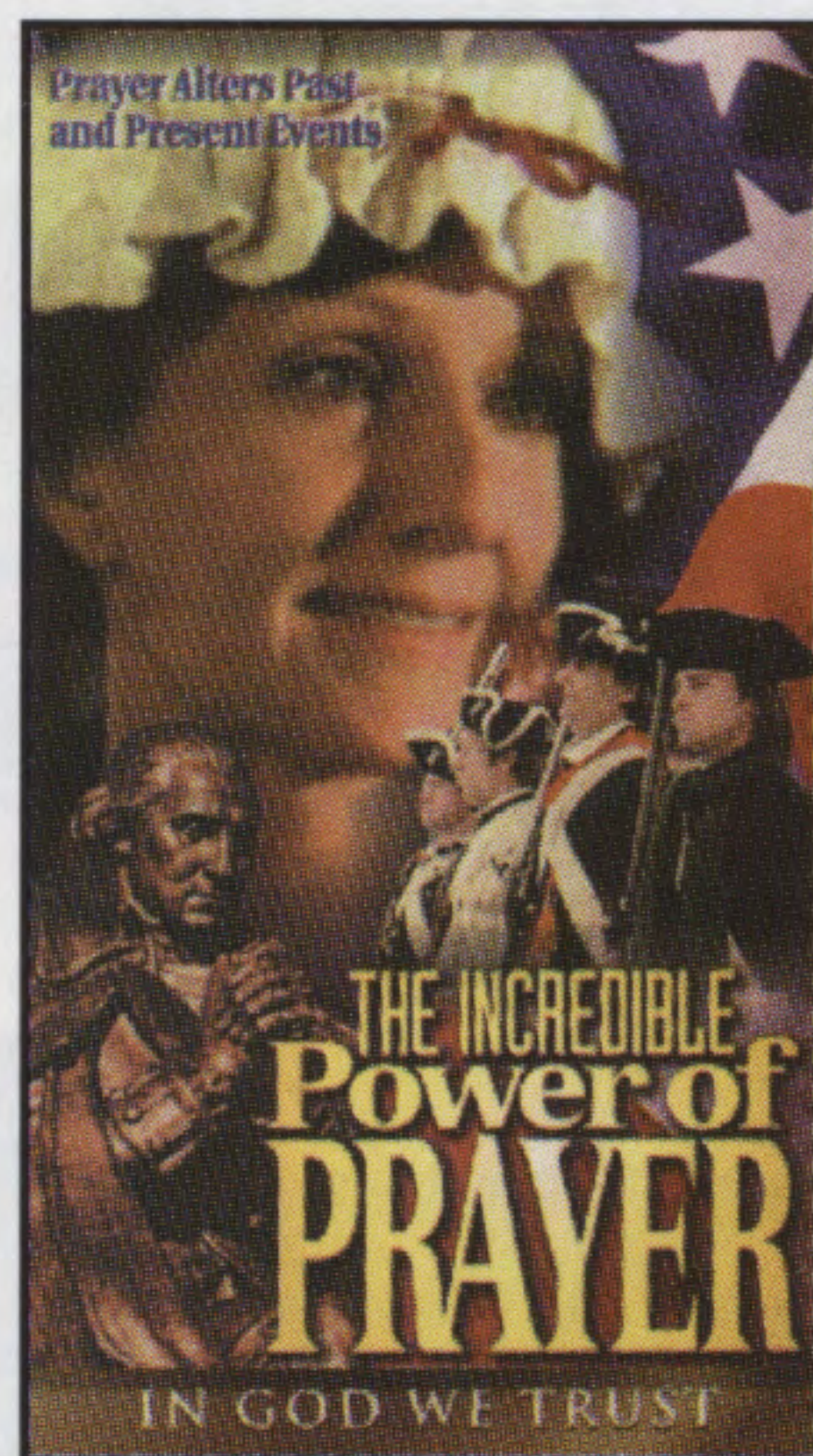
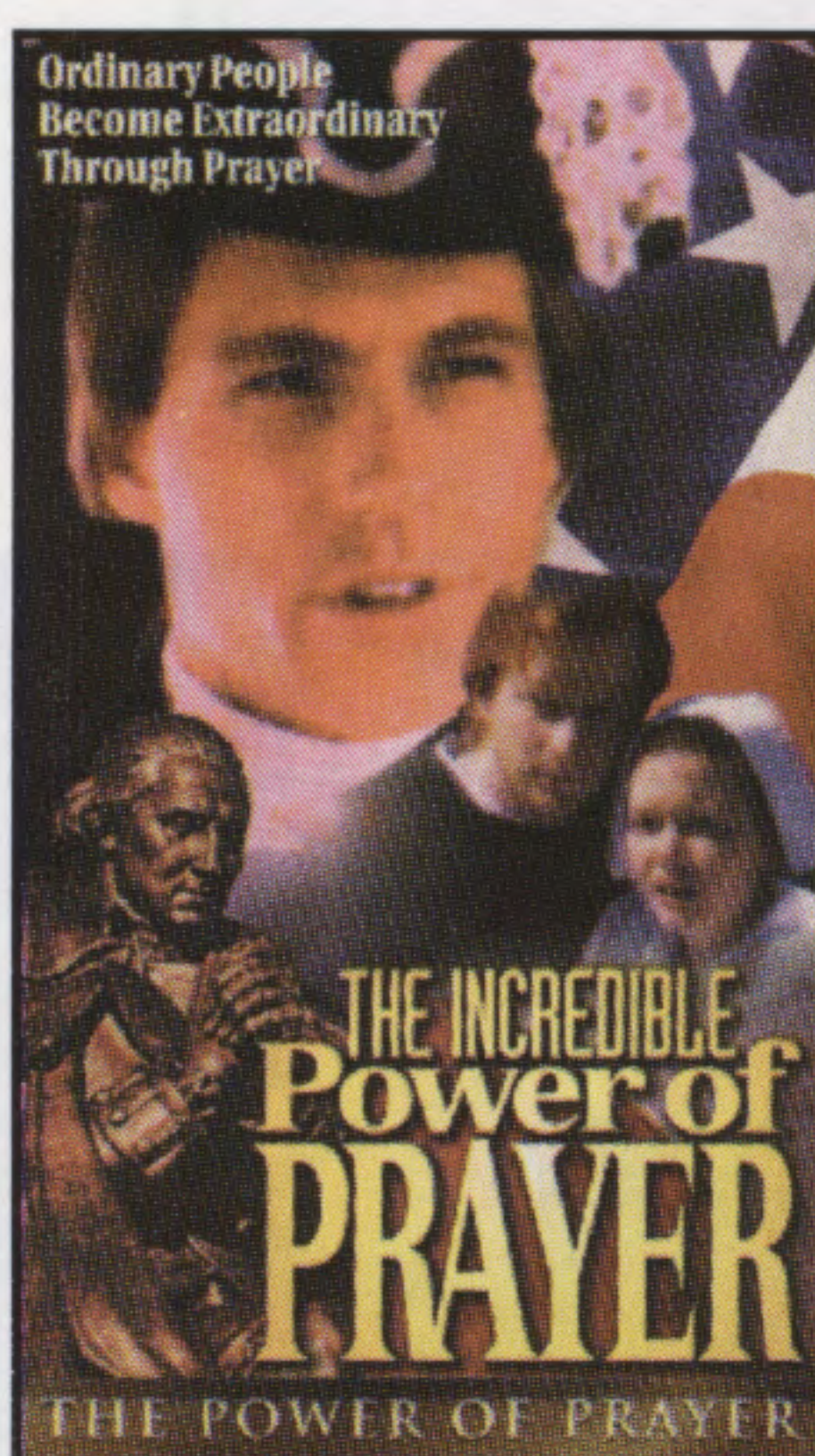

E

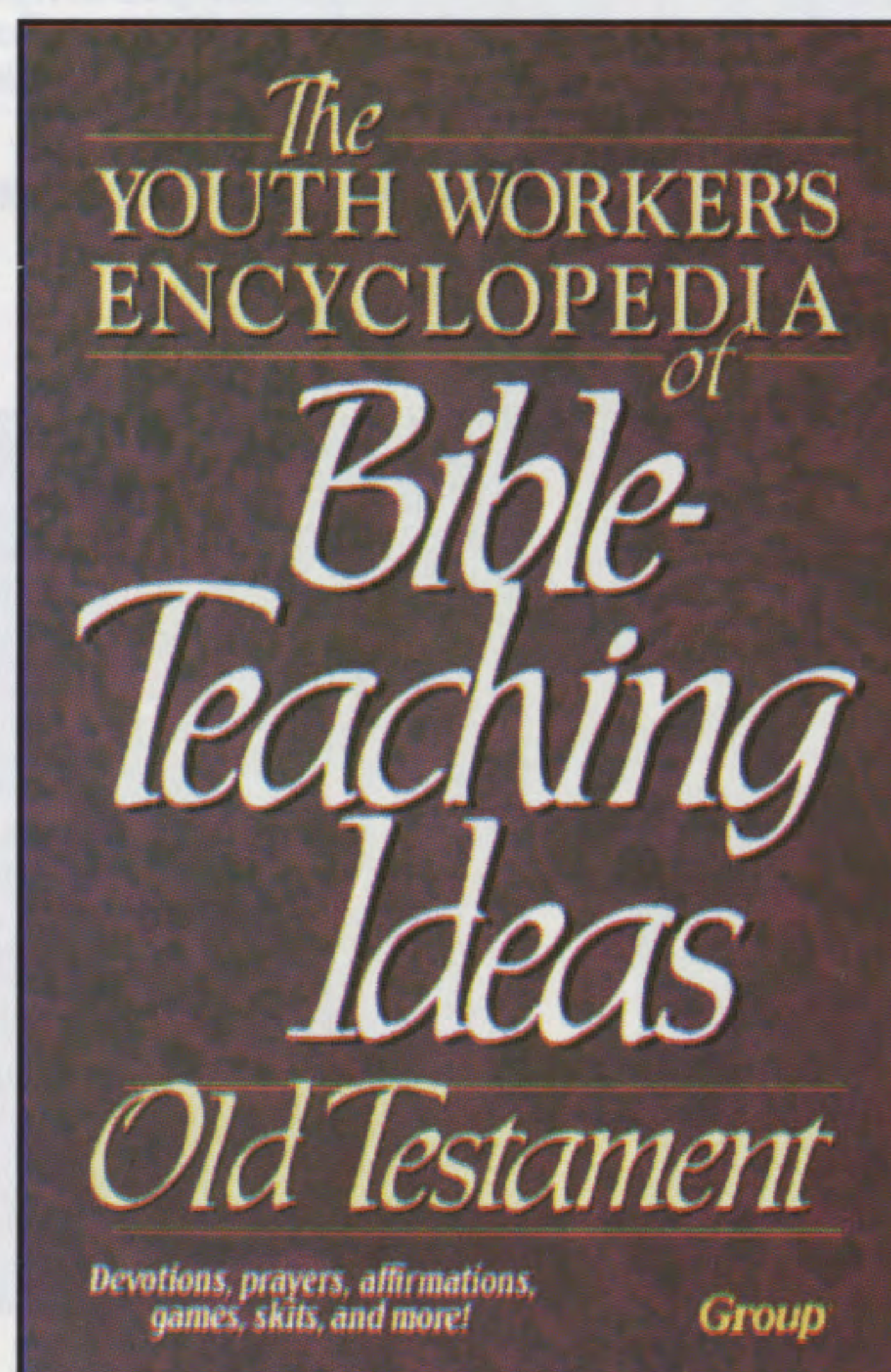

F

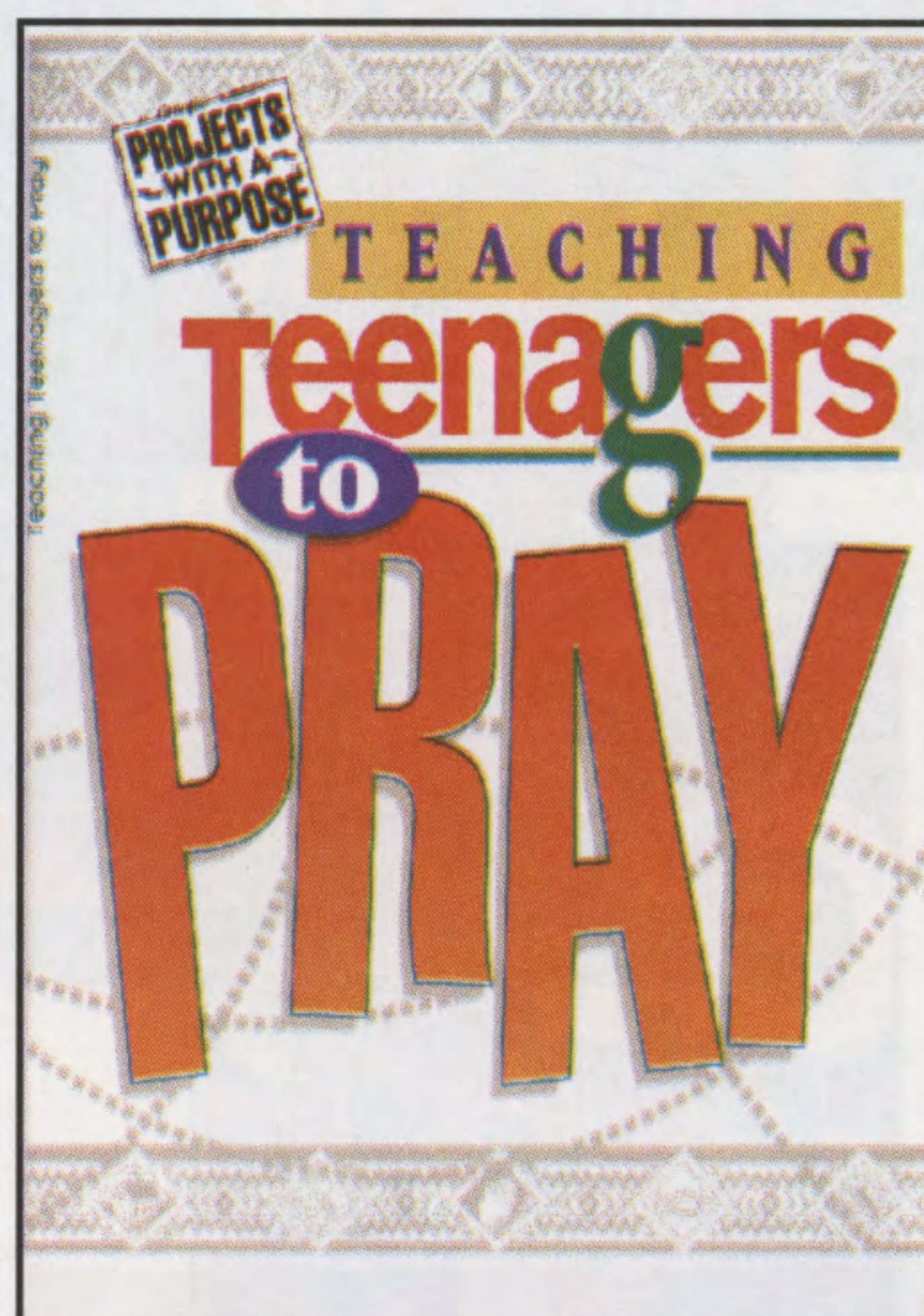

A. Adventures in Camping. Every Royal Rangers and commander needs to read and keep a copy of this revised guide. It includes winter camping and survival tips, information on map and compass orientation, constellation charts, a study of weather and its effects, discussions on forest fire prevention and conservation, full-color wildlife study posters, and much more. Paper. 02MX1036 \$7.50

B. Compass and Map Video. Come to Wyoming with a leading authority on wilderness survival, and learn more about map and compass orientation. 35-minute video blends actual outdoor examples with computer graphics. Comes with a compass and a short workbook. 26MX0609 \$29.95

C. Nexus Pioneer Compass. Lightweight compass has a plastic hinged lid that closes when not in use. Slips easily into pocket and also floats. Large sighting mirror. Red/black North-South markings and red "N" at North. Magnetic declination correction scale. Dial marked in 2 degree increments. 2 3/8 x 2 3/4" when closed. 08MX5850 \$18.00

D. Lenseset Compass. Includes luminous direction digits and needles. 2 x 2 3/4" 08MX1051 \$6.50

E. Silva Starter™ Compass. Features a millimeter scale, 5 degree graduations, red/black North and South lines, and an orienting arrow for a red-to-red needle match. 1 7/8 x 3 13/16" 08MX1052 \$10.50

F. Map Compass. Features easy-to-grip rotating compass ring and 2 degree increments for accurate readings. Liquid filled. Measures length and distance. Includes built-in magnifier for easy map reading. 2 1/2 x 4" 08MX6016 \$7.99

G. One-Quart Plastic Canteen and Cover Set. High impact plastic canteen with screw on cap and security strap. Insulated, fully lined cotton cover designed to fit on pistol belt. 08MX0782 \$4.99

H. Aluminum Scout Canteen with Strap. body made of heavy duty aluminum. Screw on cap with security chain. Cotton cover with adjustable shoulder strap. 08MX0783 \$5.99

I. Sport Bottle. Durable blue plastic beverage bottle with pop-open spout and white Royal Rangers emblem. 20 oz. 17MX0344 \$3.95

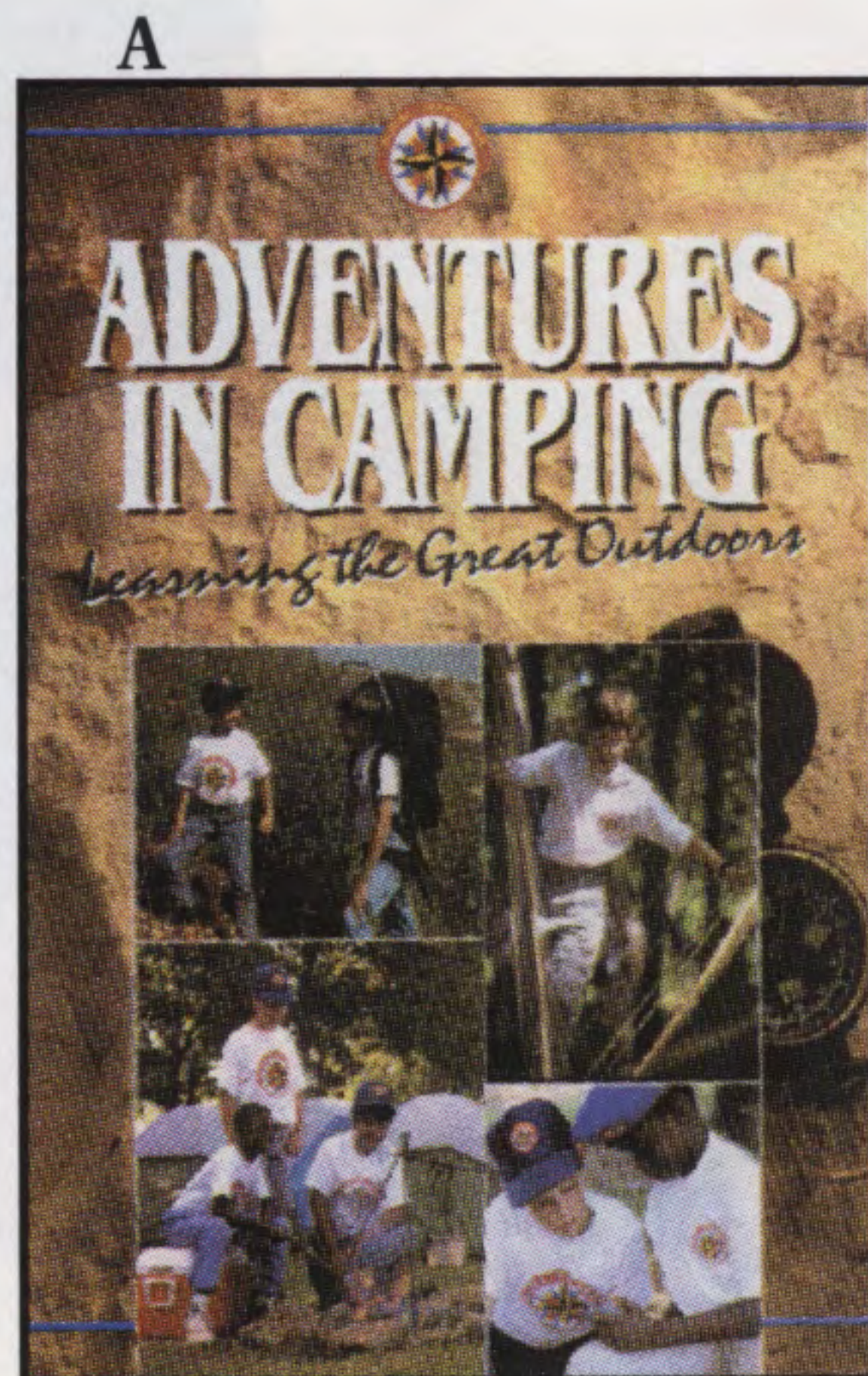

NEW!



A. 5-in-1 Survival Whistle. All-in-one survival whistle comes with shrill signal whistle, liquid-filled compass with luminous dial, waterproof match container, signal mirror, and flint fire starter. Lightweight plastic case with lanyard. Color may vary. 1 x 4 5/8"
08MX6011 \$4.50

B. G.I. Style Angle Head Flashlight. High-impact plastic flashlight with switch guard. Uses 2 D-cell batteries (not included). Comes with one extra bulb and 4 extra lenses. Black.
08MX6012 \$7.99

C. Emergency Survival Kit. Essential items packed in heavy-gauge vinyl waterproof utility pouch with carrying cord and self-sealing Velcro™ closure. Contains poncho, signal mirror, waterproof match box, waterproof matches, flashlight, whistle, compass, wire saw, emergency blanket, fish hooks, leader line and sinkers, sewing needle, and razor. 6 x 9"
08MX6013 \$14.99

D. Trail Box First Aid Kit. Assortment of 43 essential first aid items stored in a lightweight, unbreakable plastic box. Moleskin and first aid guide included. 3 1/2 x 4" size fits in back pack or tackle box.
08MX6014 \$4.99

E. 12-Function Survival Tool. Multi-function tool offers a can opener, knife edge, screwdriver, cap opener, 4-position wrench, butterfly screw wrench, magnifying lens, key chain hole, stainless steel mirror, direction auxiliary indicator, pick, and ruler. Plastic case. 2 x 3 1/4"
08MX5851 \$5.30

F. Yorkcraft Multi-Tool. More than just an ordinary pair of pliers! Enclosed in the sturdy plastic handles are fold-out pliers, screwdriver, razor sharp blade edge, large and small knife, wire cutter, and a can opener. Stainless steel pliers measure 6 1/2".
08MX5852 \$6.95

G. Tri-Fold Shovel. Features latest military design. Has 5 1/2 x 8" blade with serrated edge for cutting through hard dirt and ice. Shovel folds from 23" to 6 1/2" closed.
08MX0597 \$9.99

H. Deluxe Camp Saw. Durable steel frame with 15" detachable cross cut blade bolted with lock nuts at four stress points. Self-locking handle.
08MX6015 \$6.49

I. Back Pack. Sturdy navy blue nylon with two adjustable padded shoulder straps can be worn on shoulders or carried by its hand grip. Features roomy zippered compartment for bigger items, and a front-zippered pocket for smaller articles. 12 x 15 x 5"
17MX0358 \$19.95

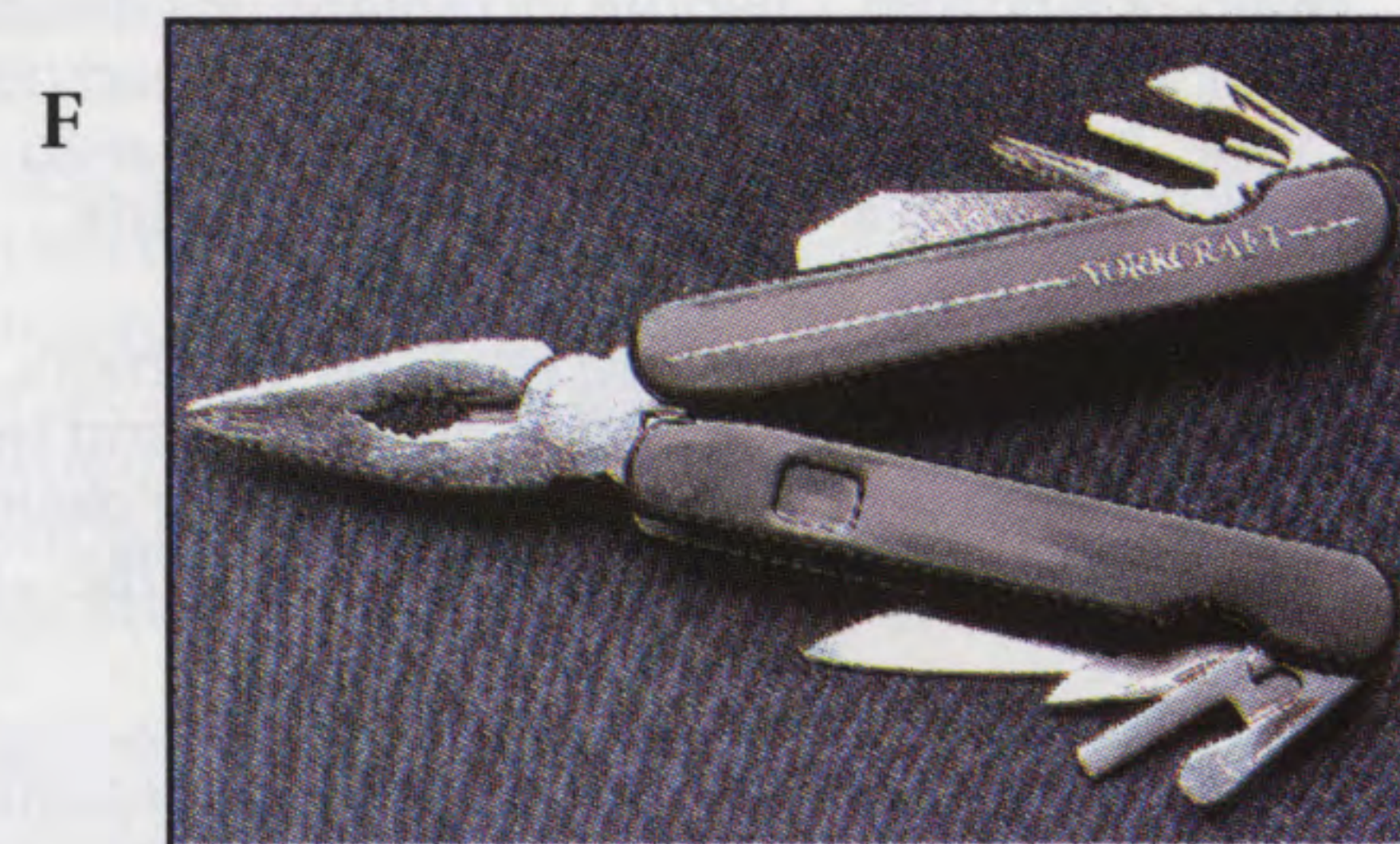
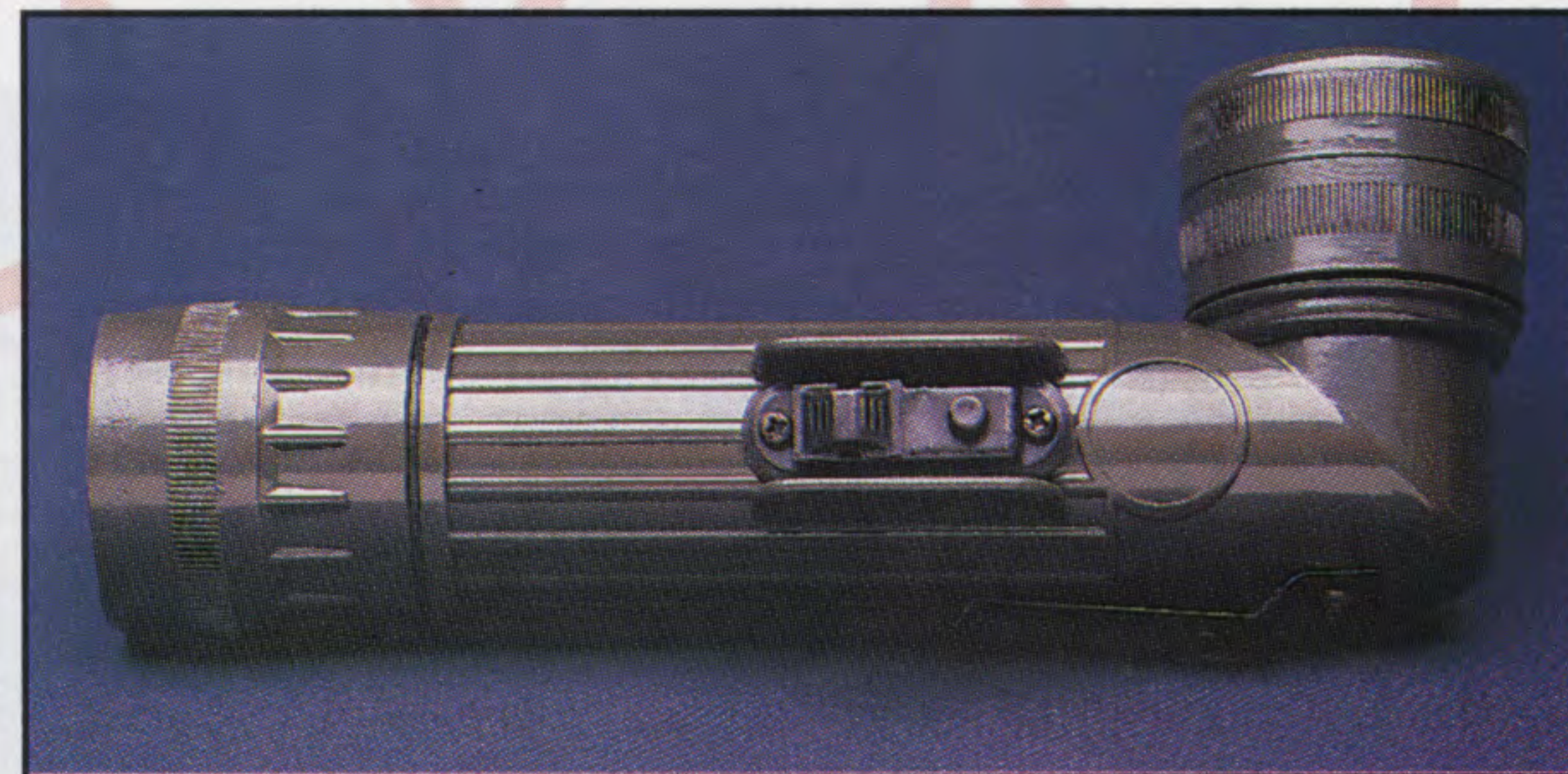



A. Chow Kit. Includes stainless steel spoon, fork, and serrated knife. Knife features built-in bottle opener. Comes complete with vinyl carrying case. 08MX5836 \$2.99

B. Camper's Combo Knife. Sturdy knife, fork, spoon, and can opener fold neatly into knife handle when not in use. 3 1/2" 08MX5853 \$9.95

C. Collapsible Cup. Sturdy plastic, telescoping drinking cup. Suitable for hot or cold drinks. Collapses easily for portability. 2 cups included. 4 oz. 08MX6009 \$1.99

D. G.I. Can Opener. The famous P-38 can opener will not bend or break. Constructed of cold rolled steel to government specifications. 08MX5839 69¢

E. Waterproof Brass Match Box. Made of heavy gauge nickel plated brass with a watertight rubber seal and instant striking surface on the side. 08MX1048 \$2.75

F. Fire Starter Stick. Starts fires quickly and safely. Leaves no odor and burns completely. Waterproof. Easy to pack and store. Non-toxic. Contains 12 sticks. 08MX6010 \$2.49

G. Folding Scissors. Stainless steel scissors completely fold for safety when not in use. 3 1/2" 08MX5854 \$3.65

H. Emergency Tube Tent. High-quality vinyl tent shelters 2 in a 6 x 8' area and fits easily into a backpack. Fire retardant and comes with 24' set-up cord. 08MX1095 \$7.25

I. Two-Man Trail Tent. Navy blue 5 x 7' A-frame tent has rear window, Velcro™ flap closures and T-type door zipper, aluminum poles, mesh-covered windows and doors, durable nylon floors, special watertight coating, and 3-season recommendations. Manufacturer's lifetime guarantee. 08MX1118 \$32.50

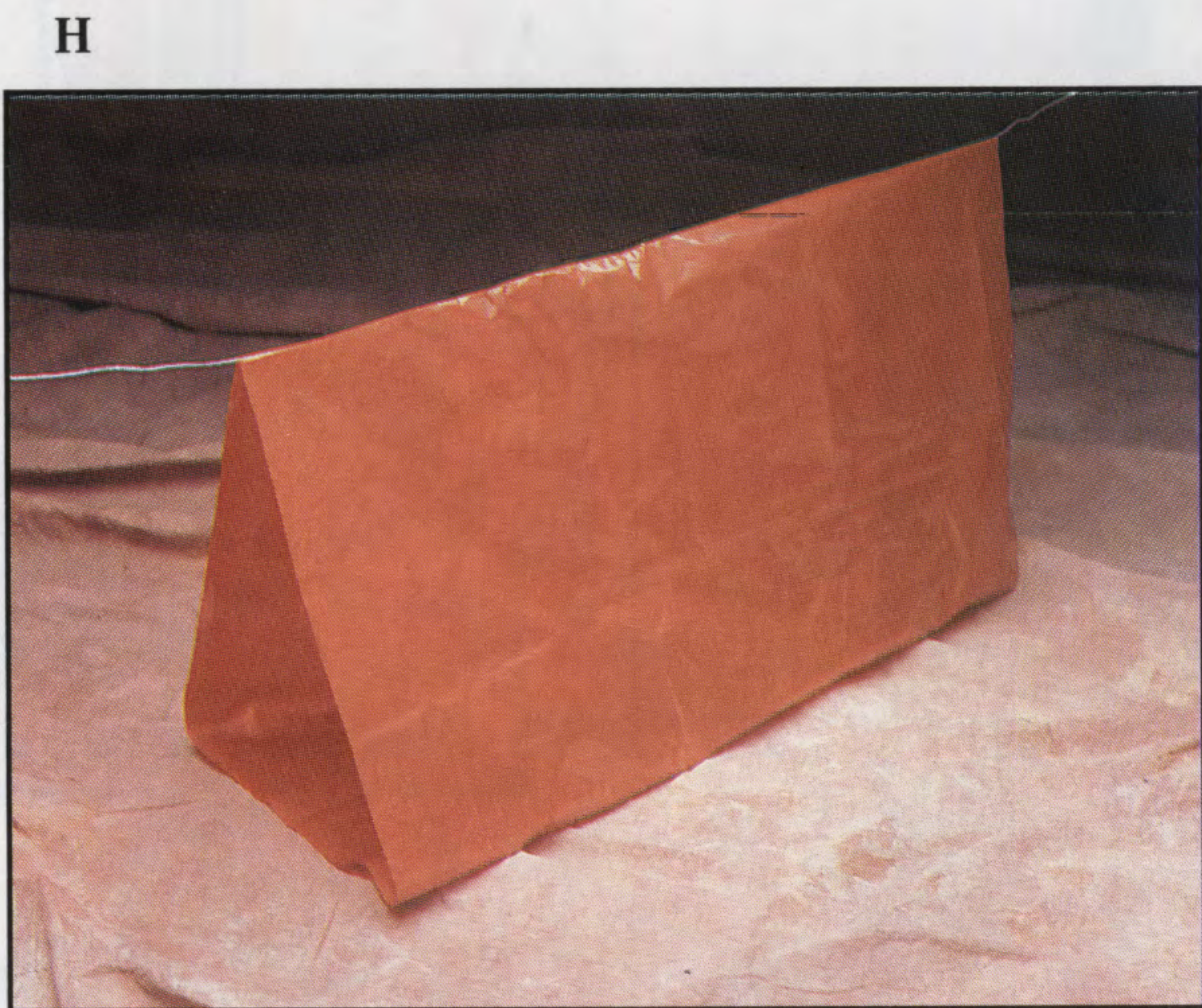
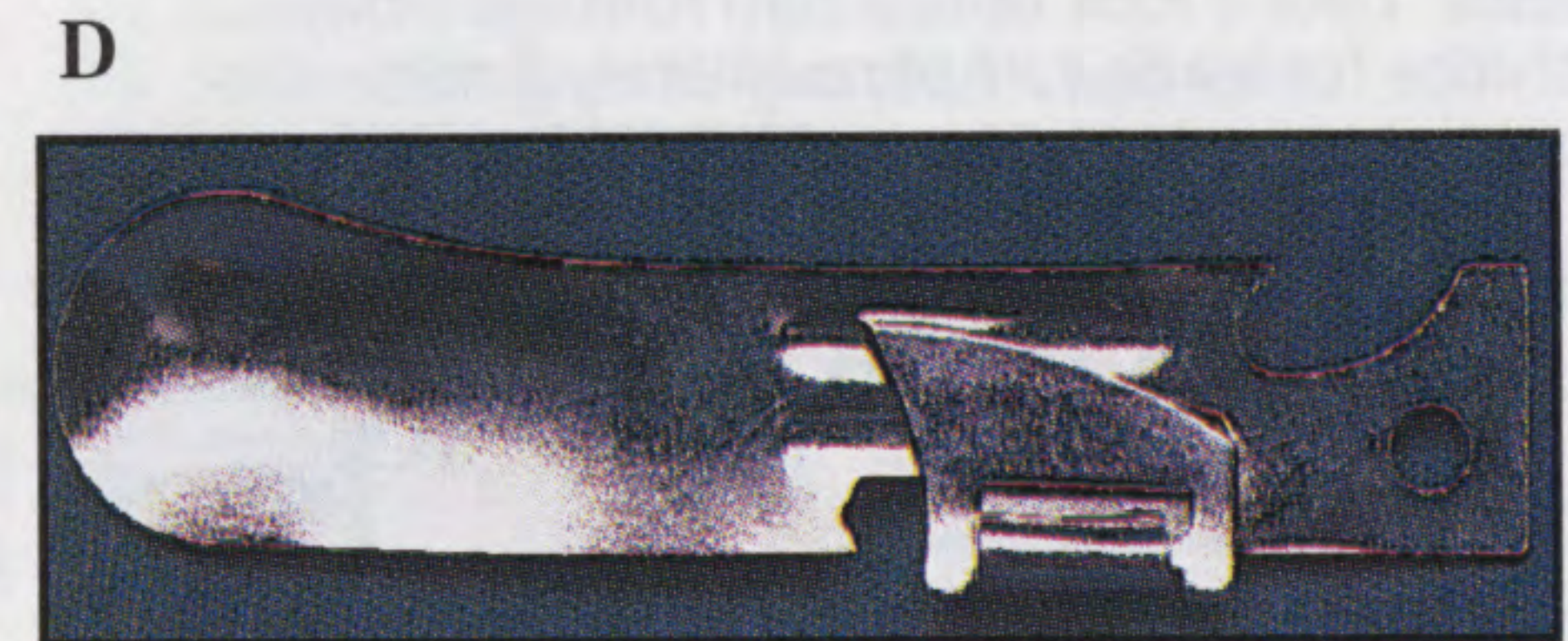
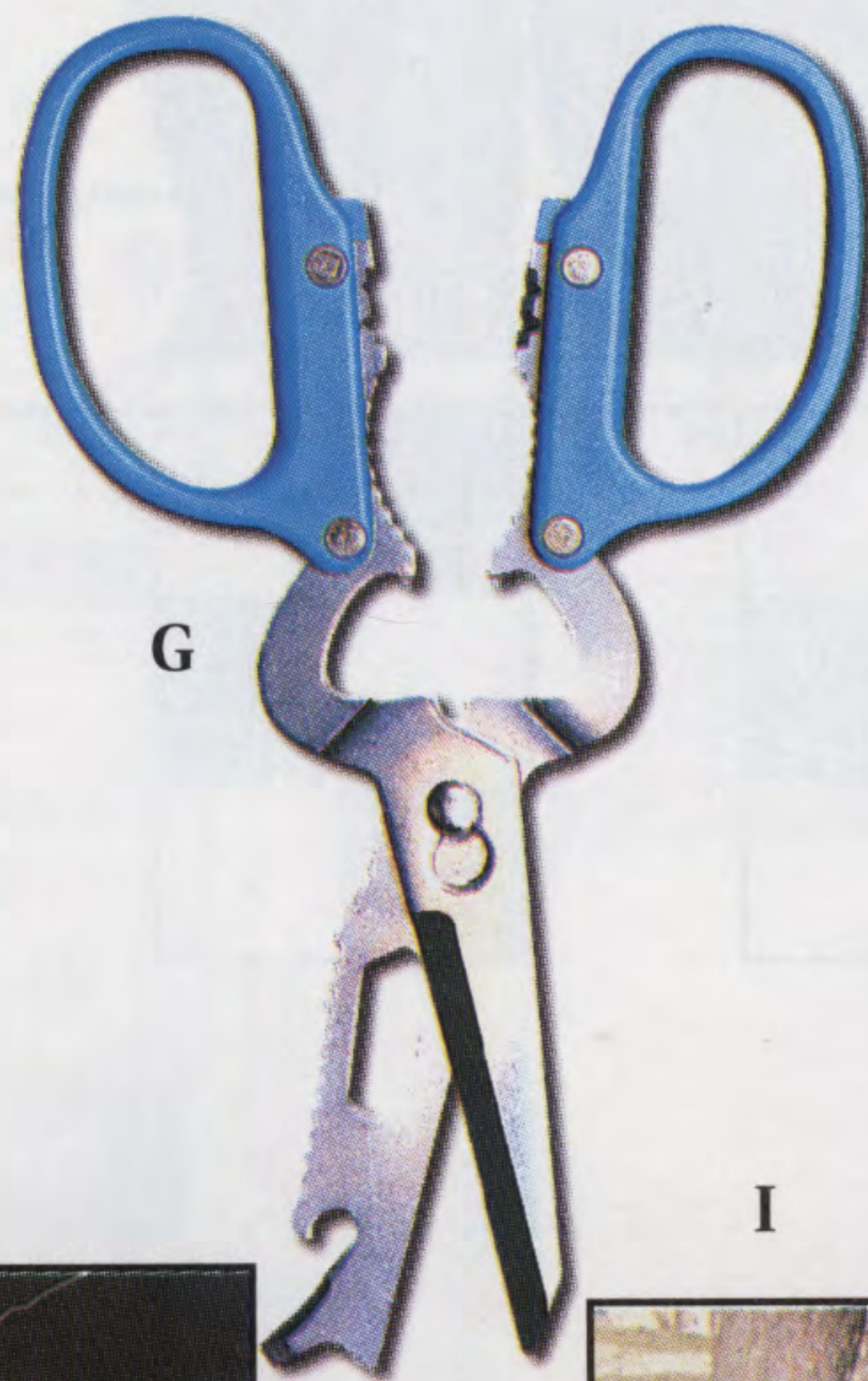

A. Pinewood Derby T-shirt. Outfit your racers in style with this bright white T-shirt. Features an "Indy style" design and the words "Pinewood Derby—The Ultimate Racing Experience." 50% cotton and 50% polyester.

| | | |
|----------------|----------|---------|
| Boys S (6-8) | 08MX5743 | \$7.99 |
| Boys M (10-12) | 08MX5745 | \$7.99 |
| Boys L (14-16) | 08MX5746 | \$7.99 |
| Adult S | 08MX5747 | \$8.99 |
| Adult M | 08MX5748 | \$8.99 |
| Adult L | 08MX5749 | \$8.99 |
| Adult XL | 08MX5750 | \$8.99 |
| Adult 2XL | 08MX5751 | \$9.99 |
| Adult 4XL | 08MX5752 | \$16.50 |

B. Pinewood Car Kit. Contains all necessary parts for a basic car—soft wood (pine) body, black plastic wheels, axles, and screws. 18MX7540 \$2.05

C. Pinewood Wedge Car Kit. Ideal for younger boys. Soft wood (pine) body is precut into basic car shape. Comes with black plastic wheels, axles, and screws. 18MX7556 \$2.30

D. Racer Display Stand. Sleek metal stand mounted on oak base holds one racer in a trophy-like position. (Car not included.) 17MX5960 \$3.98

E. Checkered Flags. Build race-day excitement and decorate your race areas with this 15' string of black and white checkered flags. Each flag 9 1/8 x 11 1/2". 30' string 17MX7398 \$6.50

F. Pinewood Derby Video. Upbeat video identifies Pinewood Derby as one of the most popular Royal Rangers events. Take a look at real film footage from a derby, with tips for leaders. Approximately 5 min. 72MX9099 \$16.95

G. Acrylic Paint Kit. Provides 6 mini-pots of paint: Red, blue, green, yellow, white, and black. Brush included. 18MX7541 \$1.50

H. Graphite Lube. Micro-fine graphite keeps wheels running smooth race after race. .21 oz. 18MX7542 \$1.50

I. Formula Glue. Hi-tack, fast setting white glue adheres to metal, plastic, and wood. Dries clear, non-toxic, nonflammable. .5oz 18MX7535 \$2.49

J. Windshield Kit. Customize your car with one of the several design options. Kit includes driver, roll bar, seat back, and vinyl patterns. Attaches with glue. 17MX5955 \$2.49

K. Headlights. Come in pairs ready to paint and glue on to car. 17MX7400 20¢

L. Steering Wheel. Wooden steering wheel attaches to car with a screw (included) and turns. 17MX7399 20¢

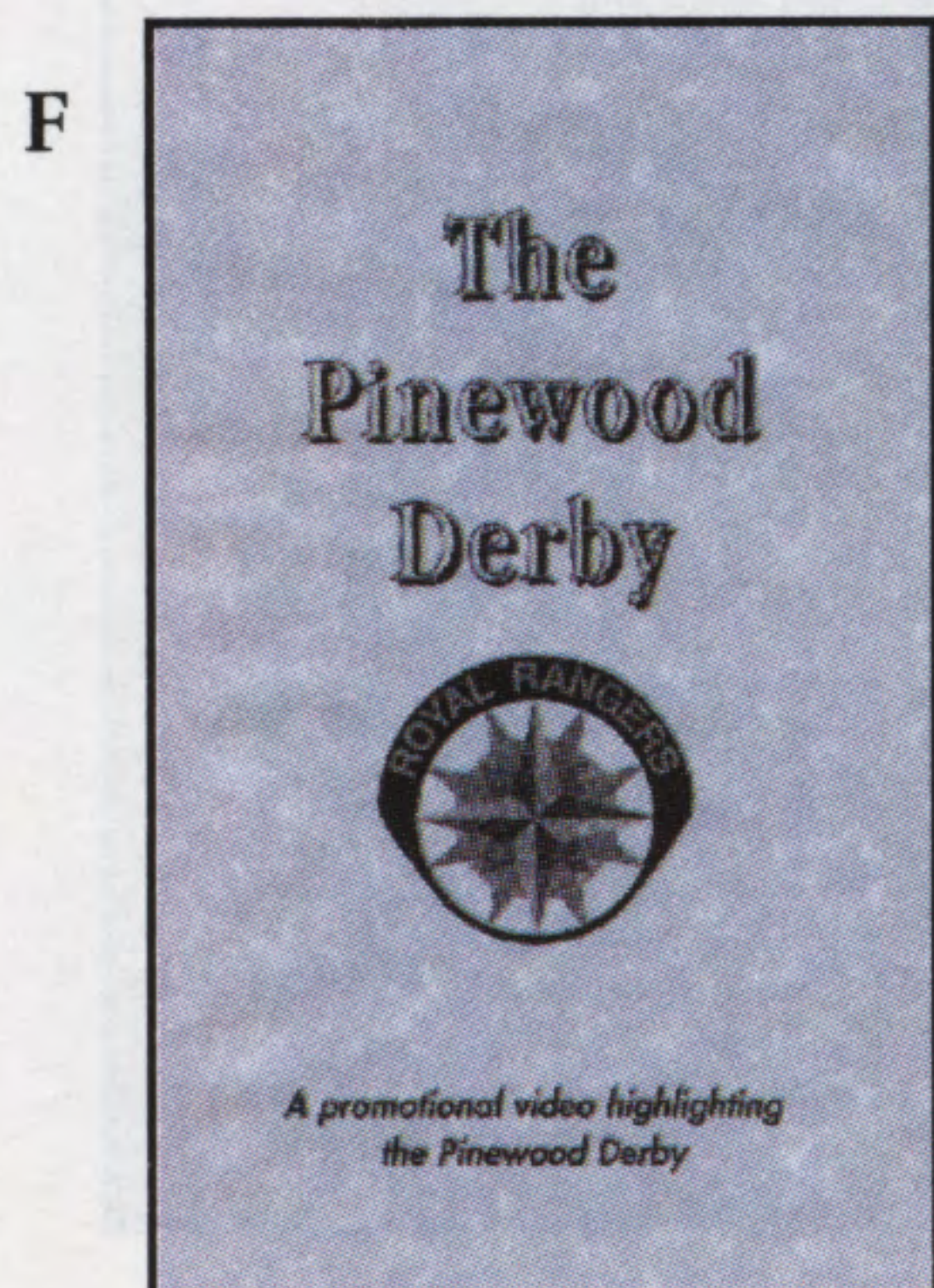
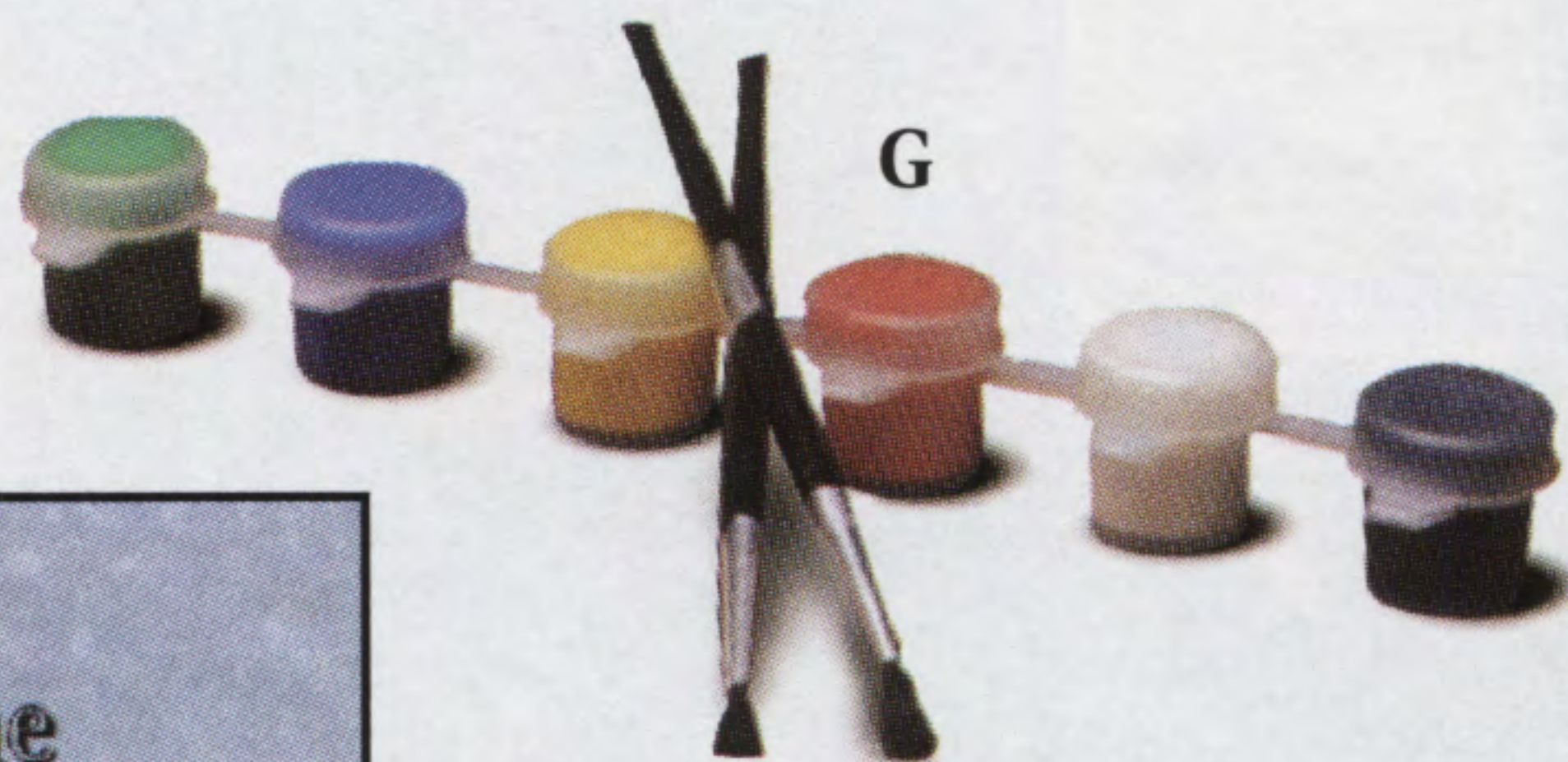
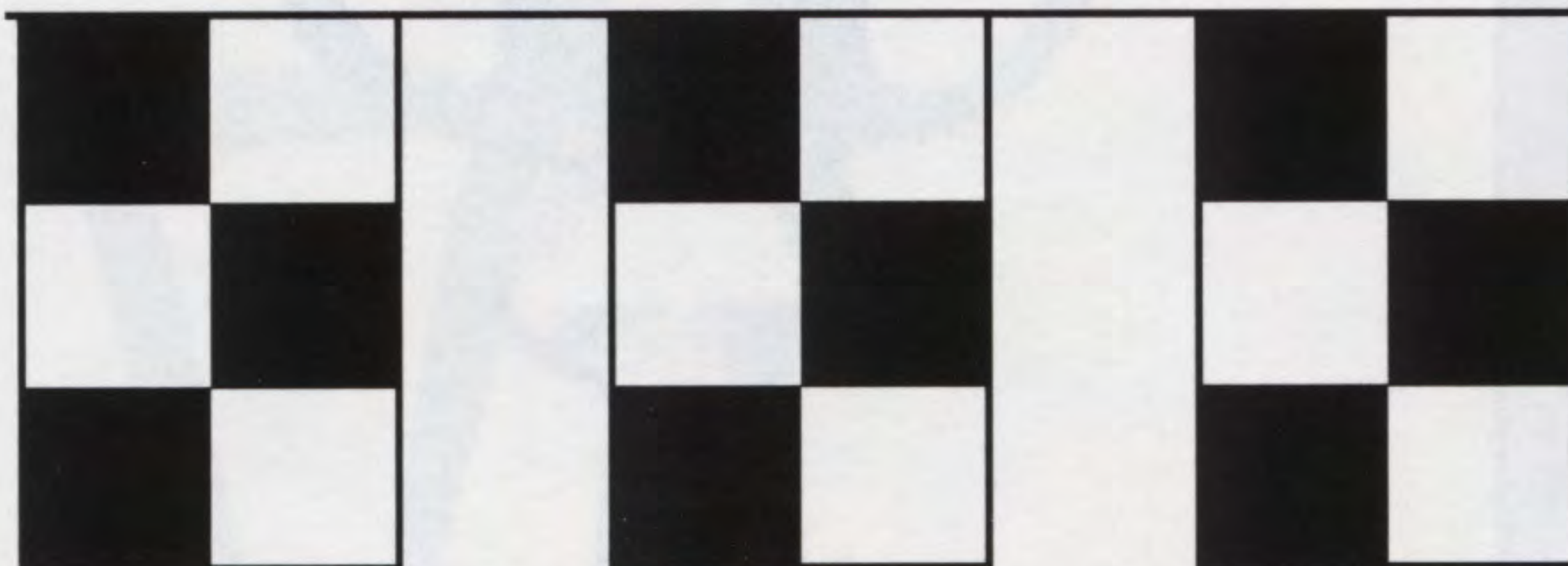
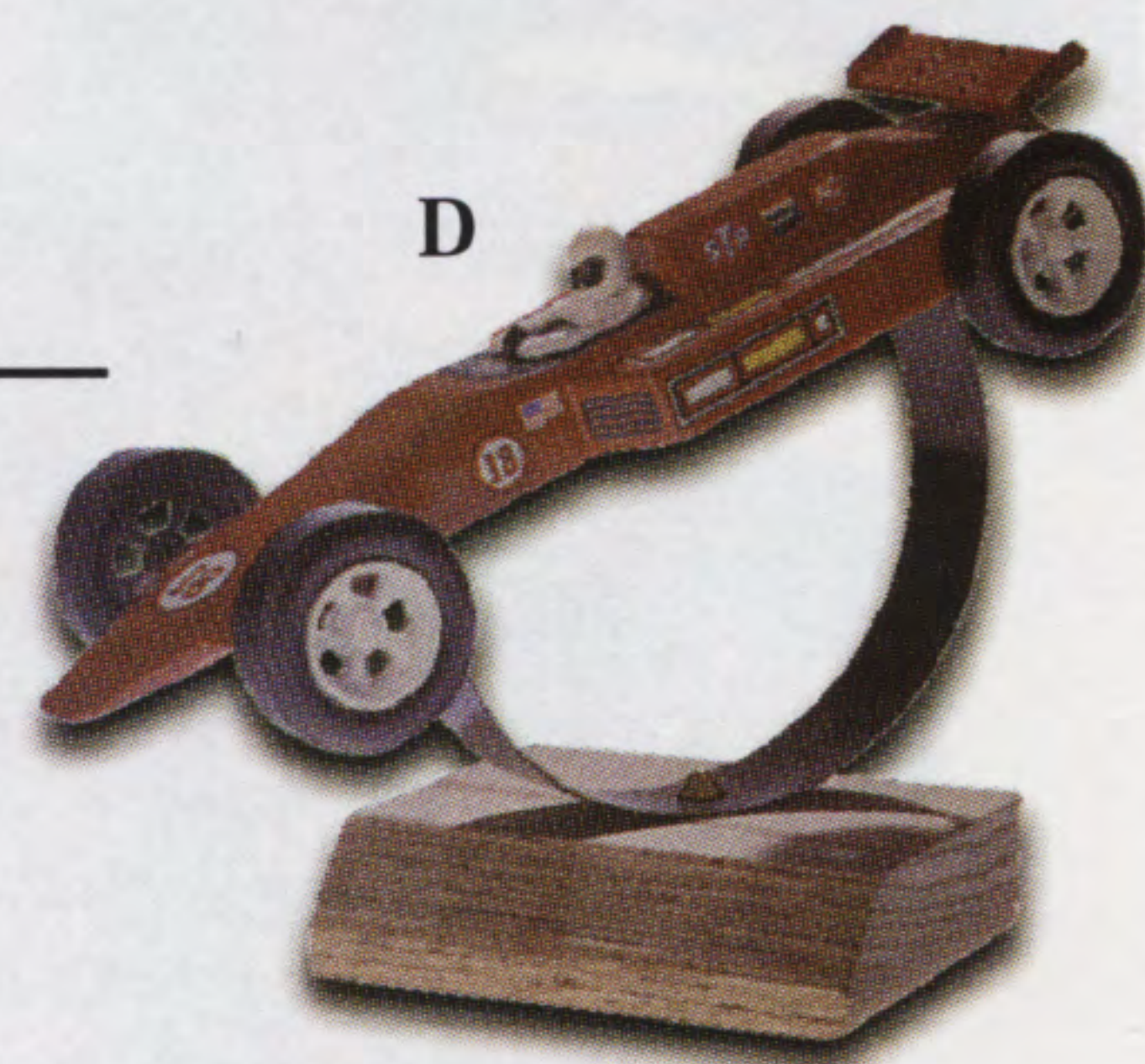
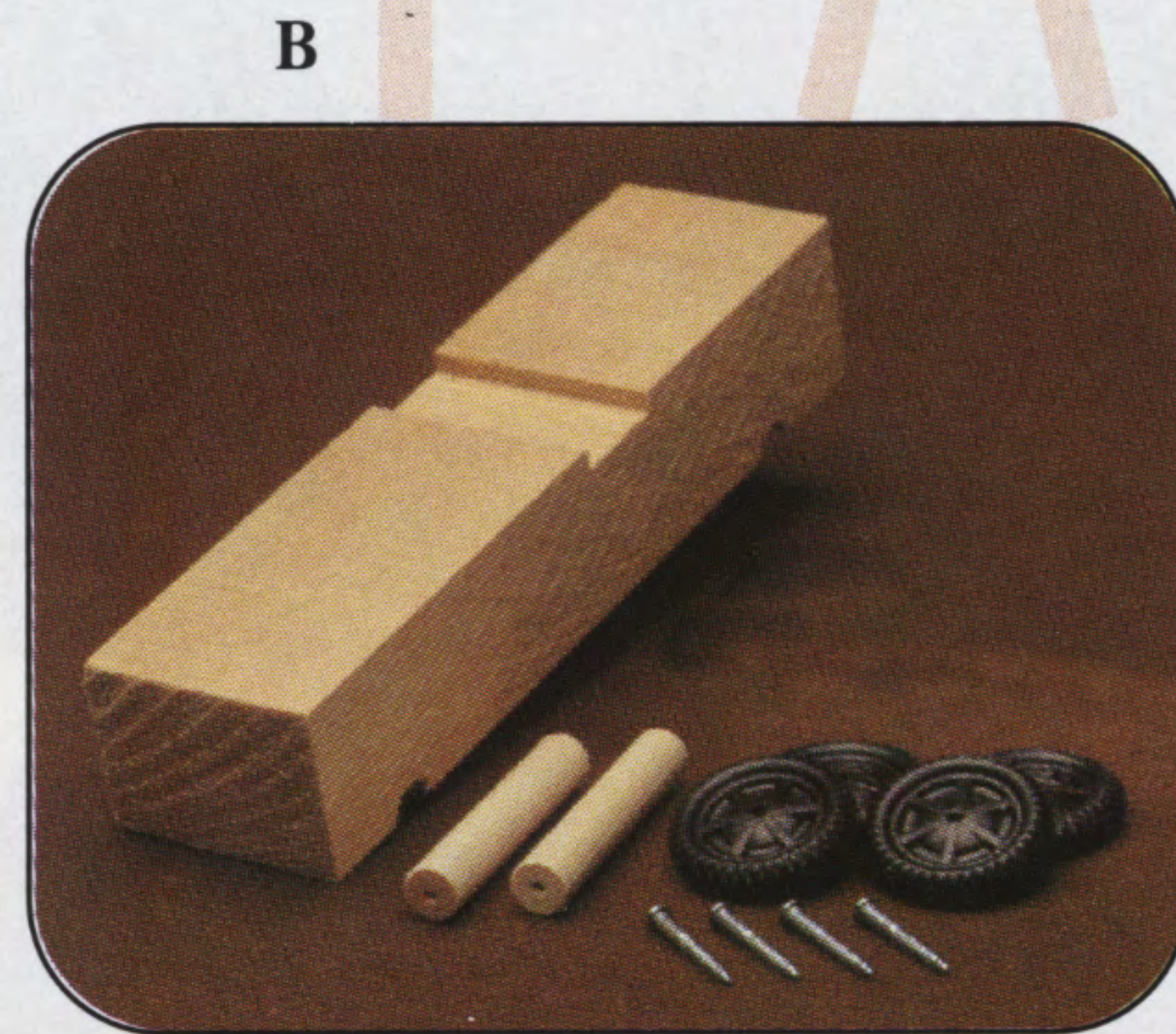



A

B



A. Royal Rangers Emblem Sticker. Official Royal Rangers emblem on adhesive sticker. Applies easily to pinewood derby cars. 1" dia. 14MX6831 49¢

B. Personalize Plates Stickers. Provides at least 4 of every letter and number (0-9) to create up to 4 personalized adhesive sticker license plates. 14MX6829 \$1.65

Wet Process Decals. Get a professional detail look with these easy-to-use decals. Dip in water, hold in place, and remove backing paper. Requires a glossy surface.

- 1. Flames. 14MX6826
 - 2. Sponsor #1. 14MX6827
 - 3. Sponsor #2. 14MX6828
 - 4. Number Sheet #24. 14MX6830
- \$2.55 each

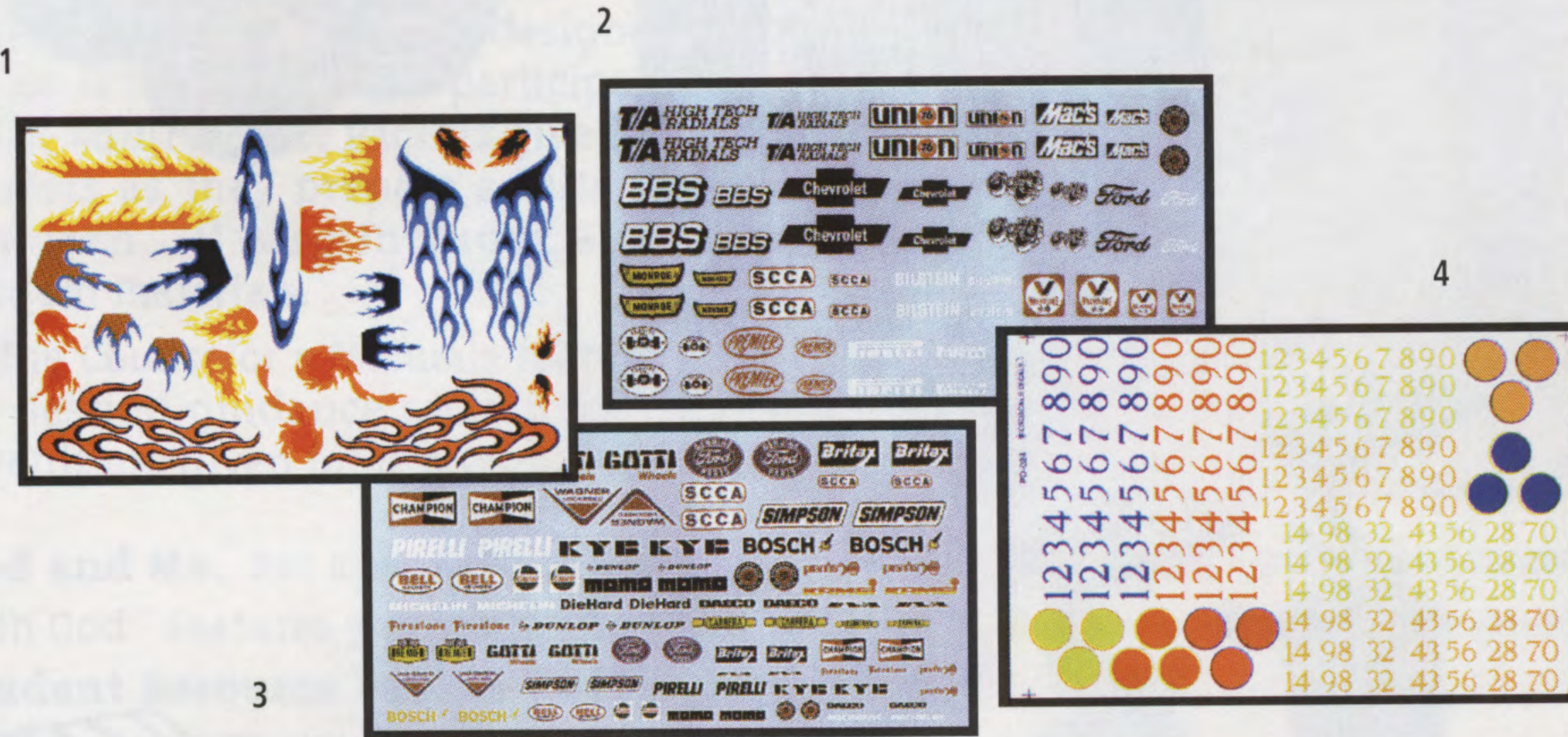

Dry Transfer Decals. High-quality, rub-on decals apply in seconds. Perfect for contours and textured surfaces.

- 5. Formula (4 x 5" sheet) 14MX6903 \$3.89
- 6. Sponsors and Numbers (4 x 5" sheet) 14MX6900 \$3.89
- 7. Nascar (4 x 5" sheet) 14MX6901 \$3.89
- 8. Custom Designs (4 x 5" sheet) 14MX6902 \$3.89
- 9. Stripes and Flames (4 x 5" sheet) 14MX6904 \$3.89
- 10. Dragon Fire (4 x 2" sheet) 14MX6905 \$2.49
- 11. Magnum (4 x 2" sheet) 14MX6906 \$2.49
- 12. Stinger (4 x 2" sheet) 14MX6907 \$2.49
- 13. Spyder (4 x 2" sheet) 14MX6908 \$2.49
- 14. Turbo (4 x 2" sheet) 14MX6909 \$2.49

Weights. Specially designed weights bring derby cars up to maximum race weight. 3.5 oz.

- 15. Lead Weight 3.5 oz. 18MX7543 \$1.50
- 16. Strip Weight Round Weight (99.9% lead free) 17MX5958 \$2.49
- 17. Combo Weight (99.9% lead free) 17MX5959 \$2.49
- 18. Stick-on Designer Weights (99.9% lead free) 17MX5957 \$2.49
- 19. Round Weight (99.9% lead free) 17MX5956 \$2.49

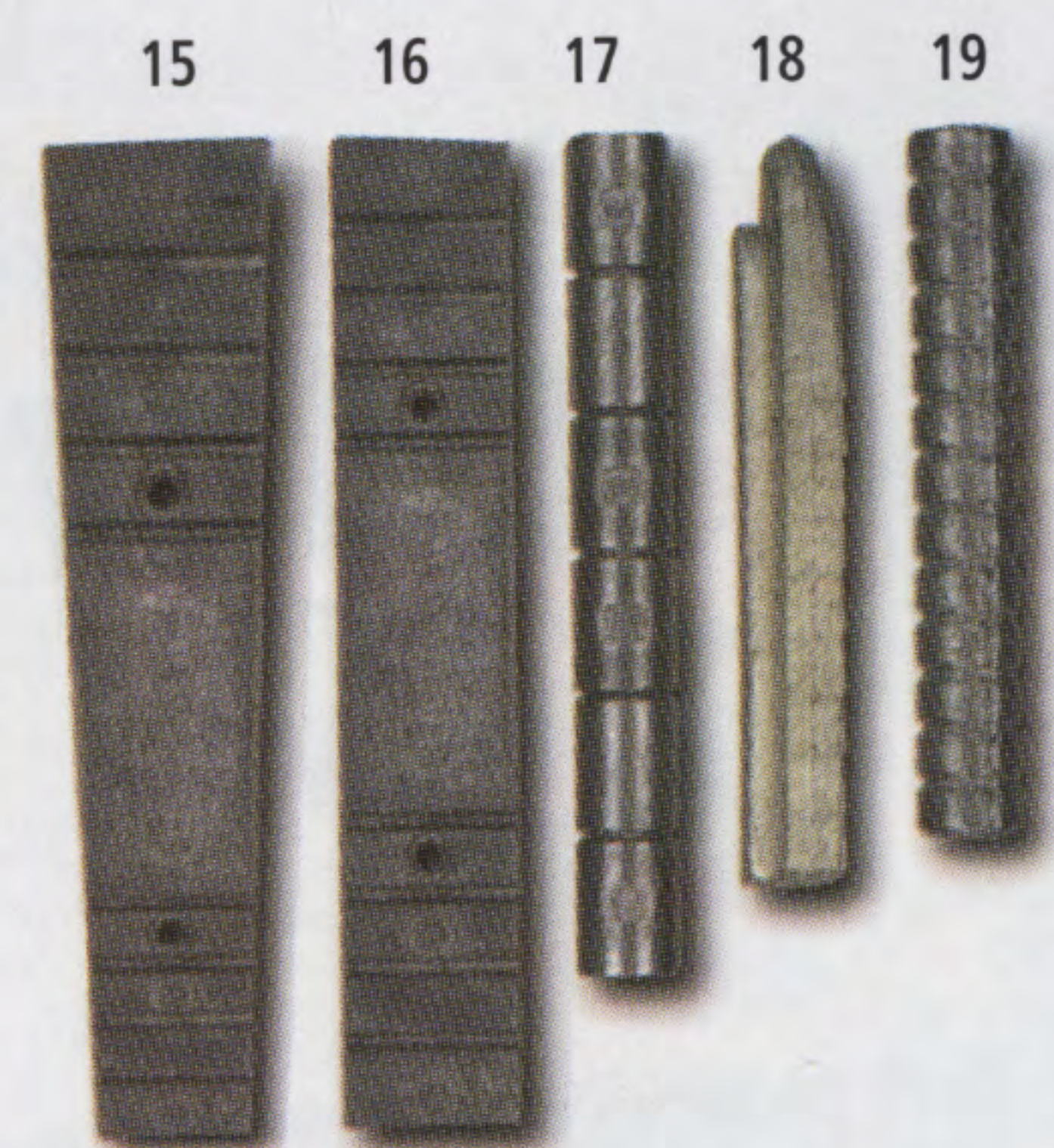
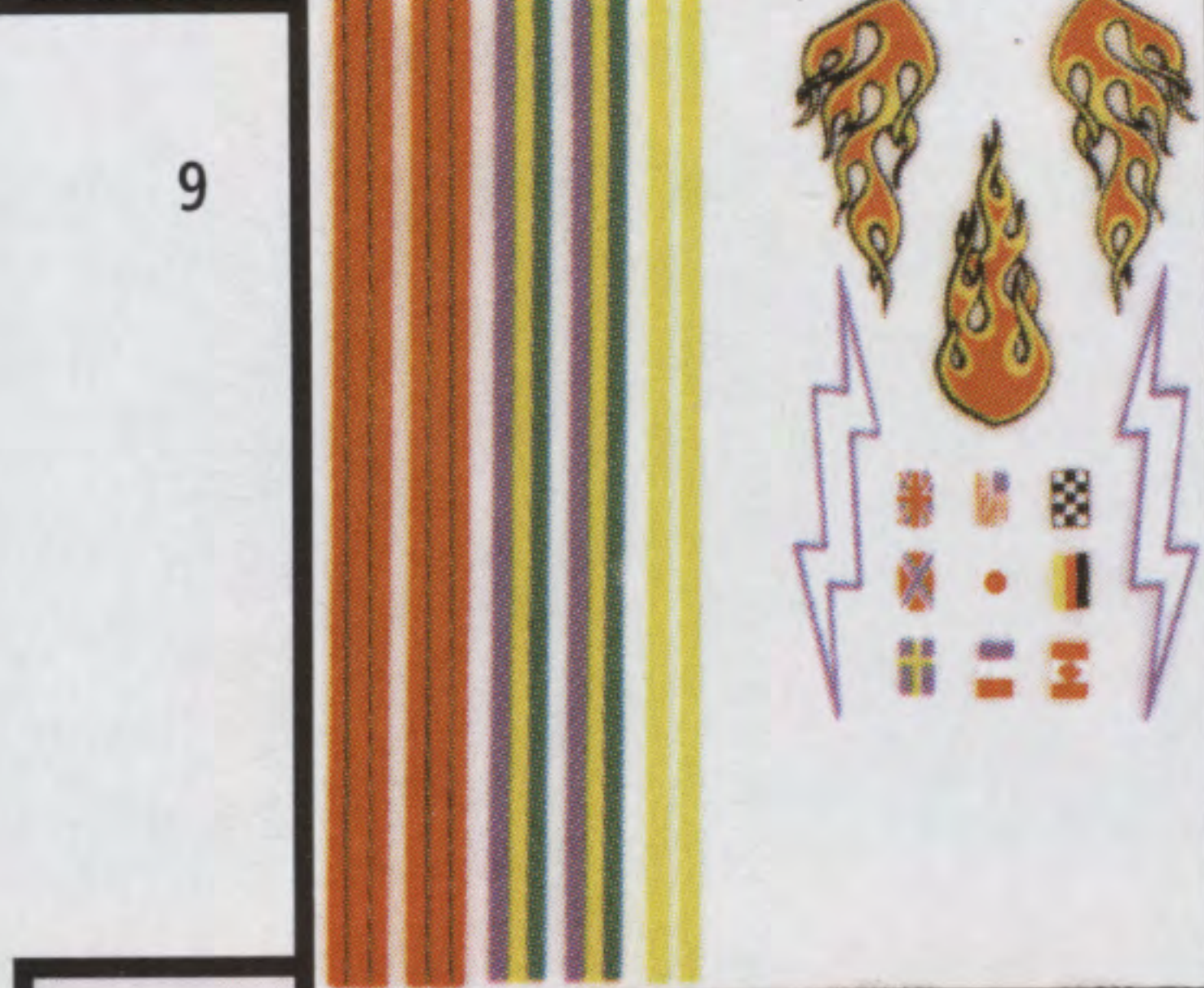
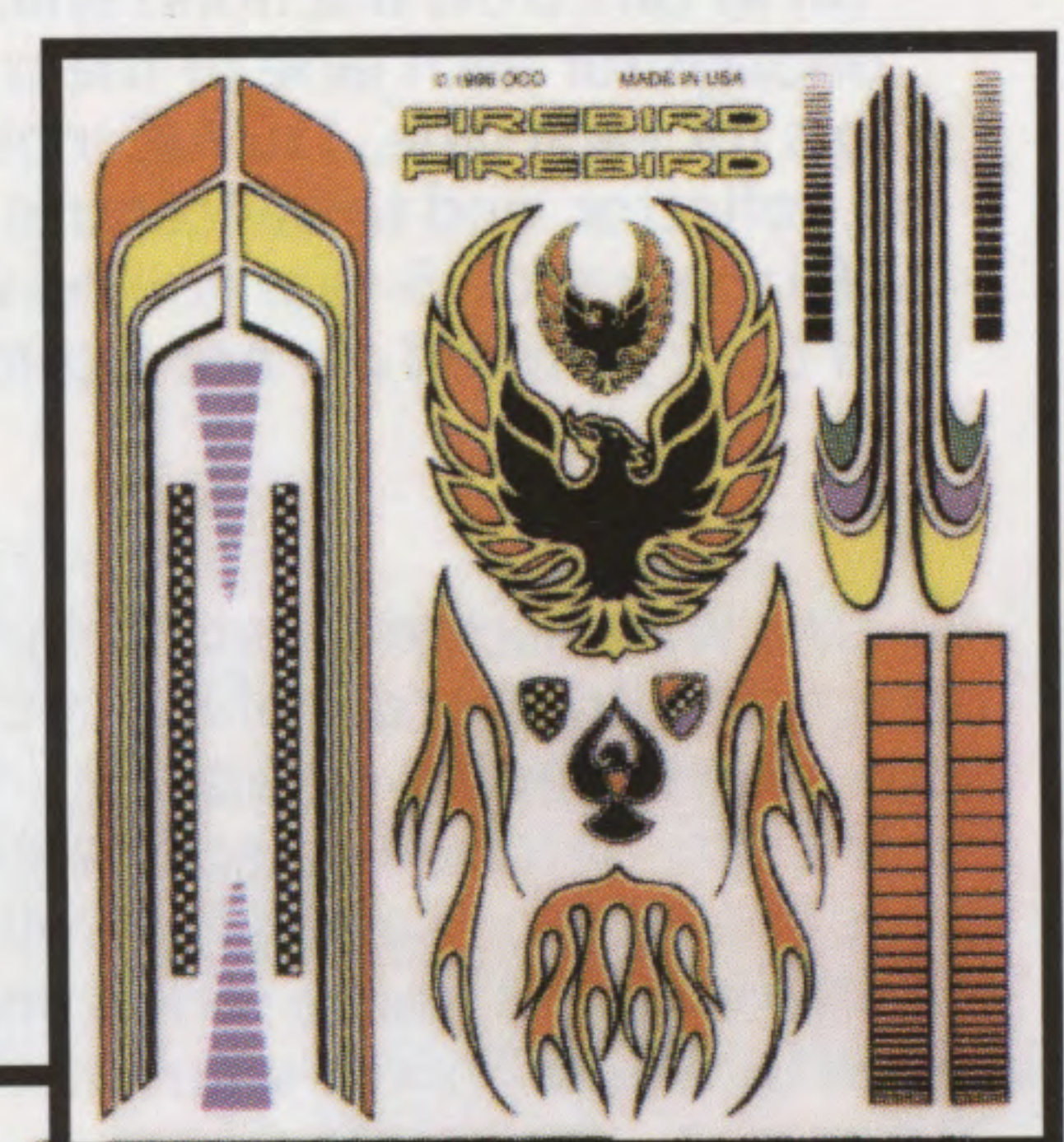

A. Lapel Pin. Full-color enameled pin has Pinewood racer, checkered flag, and gold highlights. Clutch pin back. 7/8 x 1 1/8" 15MX0117 \$1.65

B. Pinewood Derby Ribbons. Combined with trophies or given individually, these ribbons assure that every Royal Ranger receives an award for effort.

| | |
|-------------------------|----------|
| 1st Place, Blue | 17MX7393 |
| 2nd Place, Red | 17MX7394 |
| 3rd Place, White | 17MX7396 |
| Participant, Light Blue | 17MX7397 |
| 45¢ each | |

C. Pinewood Derby Medals. Each gold, silver, or bronze medal comes with a red, white, and blue ribbon. Medals are engraved with a Pinewood Derby car and name. Safety pin back.

| | |
|-------------------|----------|
| 1st Place, Gold | 17MX7436 |
| 2nd Place, Silver | 17MX7437 |
| 3rd Place, Bronze | 17MX7439 |
| \$2.95 each | |

D. Pinewood Derby Trophies. Eye-catching wood and plastic trophies display a Pinewood Derby car and place of finish.

| | | |
|-------------------|----------|--------|
| 1st Place, 7" | 17MX7390 | \$7.50 |
| 2nd Place, 5 1/2" | 17MX7391 | \$5.50 |
| 3rd Place, 4" | 17MX7392 | \$4.50 |

E. Track Kit. 3-lane track features mahogany construction, pre-cut grooves, pre-drilled holes, hardware, sandpaper, photographs, and easy-to-follow instructions. Provided supports raise the 32' track to a height of 52". Cars race between rails, not straddling a guide rail. Low-profile cars won't bottom out. Each lane is 3" wide. 08MX1009 \$210.00*

*Plus actual shipping and handling charges.
Please allow 6 weeks for delivery.

F. Lane Brain Derby Tower Detection Unit. Tells order of finish as cars cross the finish line. Features large digital 2" displays for each lane of the track. Includes photo sensors for each lane, 110 A/C input, incandescent light socket, reflector, and tower control unit. Can be used with 2 to 6 lane tracks. 5-year limited warranty. *Wooden stand and track pictured are not included.*

08MX1008 \$495.00
Allow 6 weeks for delivery.

G. Lane Brain Electronic Derby Detection Units. Automatically detects the finish order of derby cars using advanced opto-electric sensing devices. Standard equipment includes: Control unit, infrared detector with mounting hardware, 10-foot connection cables, low voltage power supply, and incandescent light source socket and reflector (light bulb not included). 5-year limited warranty.

| | | |
|-----------|----------|----------|
| 2-3 Lanes | 08MX1003 | \$199.00 |
| 4 Lanes | 08MX1005 | \$219.00 |
| 5-6 Lanes | 08MX1006 | \$249.00 |

Allow 3-4 weeks for delivery.

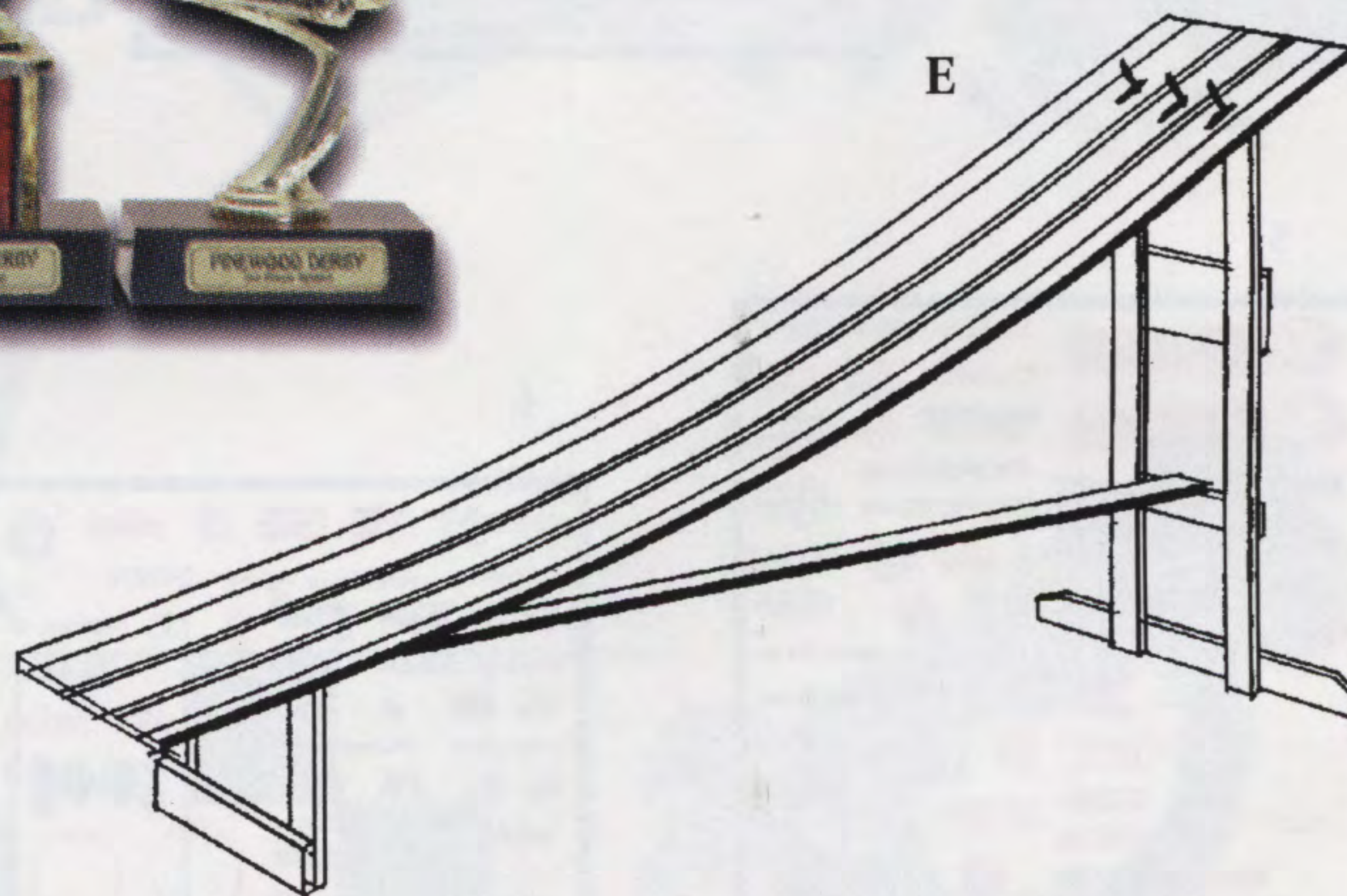
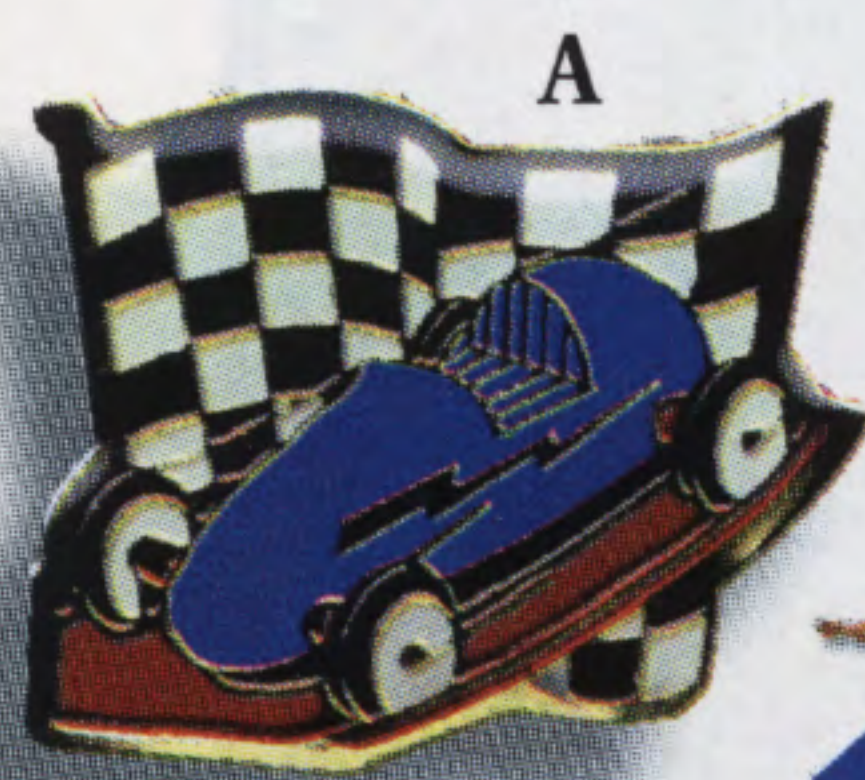

God & Country

The God and Country program provides the opportunity for adult sponsors to model their faith by working side-by-side with a young man. The series has been designed to develop an active faith in the participants.

The Adult Mentor Packets give instruction to pastors as they prepare adults for training children. It also includes a copy of the student materials.

The Counselor's Manuals feature a session-by-session guidance section for counselors. Awards are given for program completion.

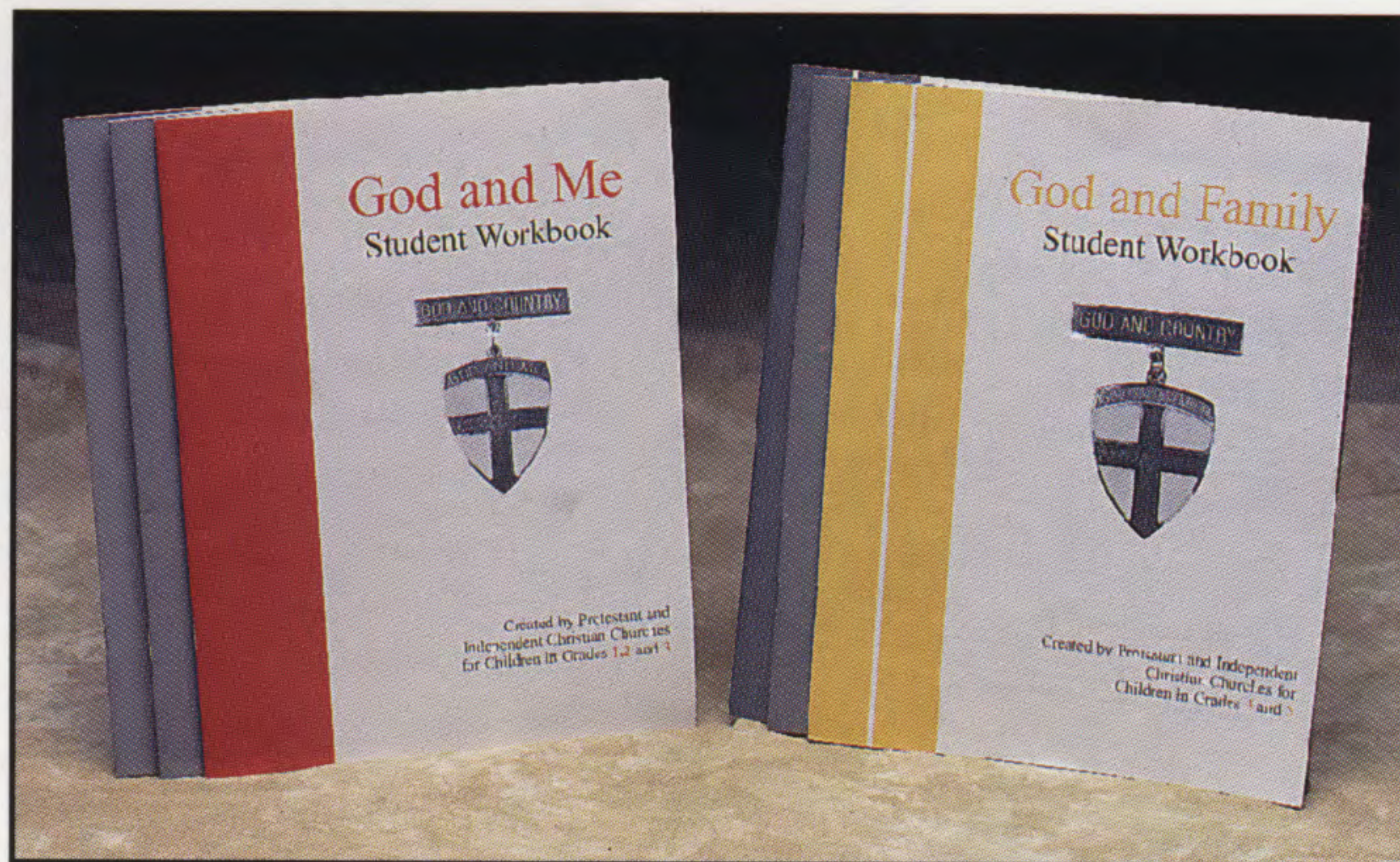

God and Me. For ages 6-8. Encourages the understanding of how we are made, why, and a child's relationship with God. Features 3 projects and 3 study sections which are offered in the student materials. 3-hole punched.

| | | | | | |
|--------------------------------|-----------------|---------------|--------------|-----------------|---------------|
| Student Resource Packet | 08MX0249 | \$3.25 | Medal | 15MX0365 | \$5.25 |
| Counselor's Manual | 08MX0248 | \$3.25 | Pin | 15MX0367 | \$3.75 |
| Adult Mentor Packet | 08MX1096 | \$3.25 | | | |

God and Family. For ages 9 and 10. Offers 6 sessions which encourage Christian nurturing in the home and church. Examines God and family, friends, future, and other areas. 3-hole punched.

| | | | | | |
|--------------------------------|-----------------|---------------|--------------|-----------------|---------------|
| Student Resource Packet | 08MX0234 | \$3.25 | Medal | 15MX0404 | \$5.25 |
| Counselor's Manual | 08MX0233 | \$3.25 | Pin | 15MX0405 | \$3.75 |
| Adult Mentor Packet | 08MX1097 | \$3.25 | | | |

God and Church. For ages 11-14. Provides an opportunity to get to know the pastor and counselor on a more personal basis. Helps boys understand their church's structure, objectives, and mission. The Student Resource Packet is divided into 2 sections: God and His work, and Christians and their work. 3-hole punched.

| | | | | | |
|--------------------------------|-----------------|---------------|--------------|-----------------|---------------|
| Student Resource Packet | 08MX0236 | \$3.25 | Medal | 15MX0406 | \$5.25 |
| Counselor's Manual | 08MX0235 | \$3.25 | Pin | 15MX0407 | \$3.75 |
| Adult Mentor Packet | 08MX1098 | \$3.25 | | | |

God and Life. For ages 15-20. Offers guidance exercises for students wanting to increase their faith; make responsible vocational choices; and find identity in family, church, and country. Includes a 6-section study for teens with activities. 3-hole punched.

| | | | | | |
|--------------------------------|-----------------|---------------|--------------|-----------------|---------------|
| Student Resource Packet | 03MX3880 | \$3.25 | Medal | 15MX0408 | \$5.25 |
| Counselor's Manual | 03MX3870 | \$3.25 | Pin | 15MX0409 | \$3.75 |
| Adult Mentor Packet | 08MX1099 | \$3.25 | | | |





GOSPEL PUBLISHING HOUSE
 1445 BOONVILLE
 SPRINGFIELD, MO 65802-1894

NONPROFIT ORG.
 BULK RATE
 U.S. POSTAGE
PAID
 PERMIT NO. 48
 SPRINGFIELD, MO



800.647.4310



75-2028 20M 12/98