

# ROYAL RANGERS

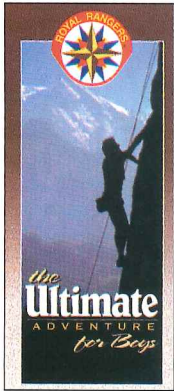

# CATALOG

**PUBLICITY & RECRUITMENT**



**Royal Rangers: The Ultimate Adventure for Boys**

Promotes the Royal Rangers program to potential rangers. Includes a brief summary of the gospel and an invitation to personally accept Christ. Pamphlet.

English 72MX9007 FREE  
26 or more, 15¢ ea.  
Spanish 72MX9010 FREE  
26 or more, 15¢ ea.



**Royal Rangers Clip Art CD-ROM**

Provides logos and art for letters, awards, bulletins, and newsletters. Features artwork for all Royal Rangers programs, Ranger Kids through Expedition Rangers, including merits, achievements, and mascots.

**Note: It is illegal to use any of this art on saleable items without written permission from Gospel Publishing House.**

28MX1551 \$14.99



**Council of Achievement Bulletin**

Use these bulletins for quarterly Councils of Achievement to recognize your boys' accomplishments. 8½ x 11"

08MX7001 50 for \$3.48  
1000 for \$57.60

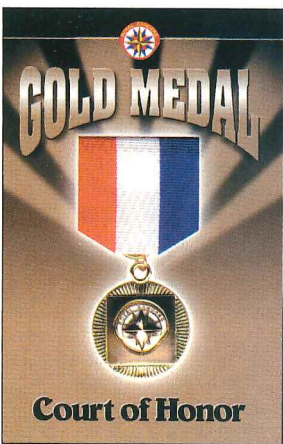

**Gold Medal of Achievement Bulletin**

Imprinted on the outside front with "Gold Medal Court of Honor" and the medal. Back cites 2 Timothy 2:21. Inside is blank and ready for printing. 8½ x 11½"

72MX9069 100 for \$15.00



**Royal Rangers Postcard**

Let your boys and commanders know about upcoming events, invite new boys to your group, and communicate with parents. 5½ x 3½"

11MX6330 25 for \$5.50

**Royal Rangers Videos (NOT SHOWN)**

Provides an overview of the Royal Rangers program and encourages involvement. Each video approximately 4-5 minutes.

**One in a Million.** A lonely boy joins Royal Rangers and finds activities, friends, and Jesus. Set to music.

72MX9046 \$15.00

**Reaching Boys for Christ.** Highlights the activities, goals, responsibilities, and effectiveness of the Royal Rangers program.

72MX9128 \$10.00

**Building Bridges to the Hearts of Boys.** Explains the goals, ministry philosophy, and objectives of the Royal Rangers program.

72MX9131 \$15.00

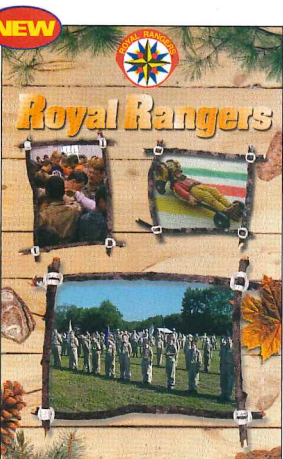

**Royal Rangers Bulletin**

Great for Royal Rangers services and ceremonies. 8½ x 11"

08MX7002 50 for \$3.48  
1000 for \$57.60

CALL TODAY  
**1.800.641.4310**

## ROOM DÉCOR

### Royal Rangers Advancement Awards Chart

Post in every Royal Rangers room to allow your boys to see the scope of the program. Makes a great teaching tool for training new leaders. 24 x 35"

23MX8946 \$2.50



### Royal Rangers Posters

Inspire your outpost with these vivid, full-color posters that boldly display Royal Rangers values and commitment. 20 x 26"

Royal Rangers Emblem	23MX8948	\$2.50
Royal Rangers Code	23MX8947	\$2.50
Royal Rangers Pledge	23MX8949	\$2.50
Royal Rangers Motto/Golden Rule	23MX8951	\$2.50

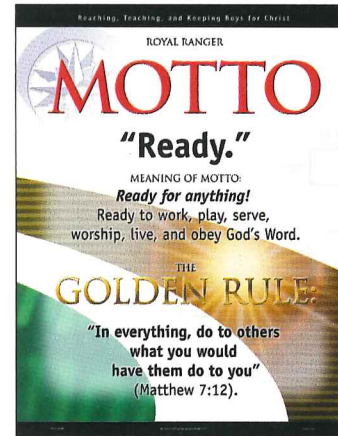
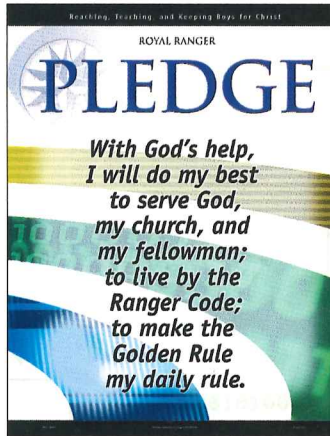
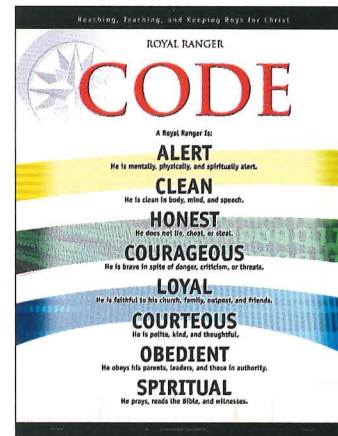
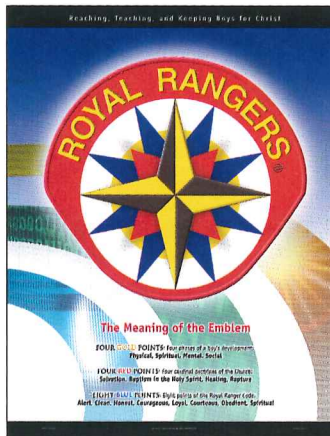

### Royal Rangers Flag Desk Set

Displays the Royal Rangers, U.S., and Christian flags together. Black base. Flag size: 4 x 6" Height: 10 1/2"

08MX5632 \$10.99

### Royal Rangers Flag Set

8' 2-piece varnished hardwood pole with 6" gilded wood spear ornament, gilt-finish floor stand, and 3 x 5' Royal Rangers flag. Flag features the Royal Rangers emblem on white long-lasting Dura Lite nylon. Resists wind fraying.

Flag Set	08MX5635	\$98.00
Flag only	08MX5613	\$52.00

### Royal Rangers Classroom Flag

Attached to 35" staff. 16 x 24" 08MX7262 \$14.99

### U.S. Classroom Flag

Attached to 35" staff. 16 x 24" 08MX7281 \$9.99

### Christian Classroom Flag

Attached to 35" staff. 16 x 24" 08MX7282 \$10.99

**Classroom Flag Holder, Wall Mount.** For use with classroom flags listed above. 08MX7283 \$2.50

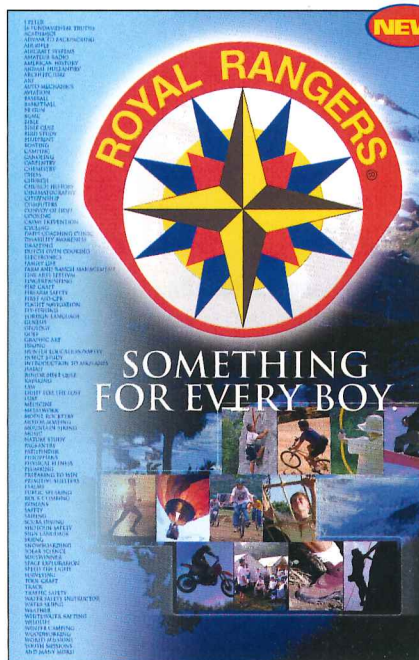

**ROYAL RANGERS Program Poster**  
Display on church bulletin boards to let people know your church has Royal Rangers for boys. 11 x 17" 23MX8950 \$2.50

## ADDITIONAL RESOURCES

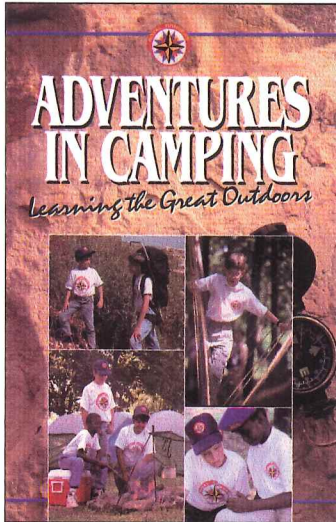

### Adventures in Camping

This manual is important reading for every Royal Ranger. Teaches boys and commanders what they need to know to have a safe and comfortable outing. Also provides pictures and instructions for many camping related activities such as knots, fire building, and campcraft projects. Paper.

02MX1036 \$7.95

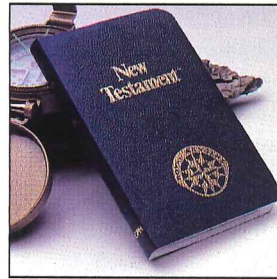

### Royal Rangers New Testament

The official Royal Rangers New Testament. Features a presentation page, Royal Rangers code, motto, pledge, and plan of salvation verses. Dark blue morocco cover. Front and spine stamped with non-tarnish gold. Royal Rangers emblem on front. 3 x 4 1/2"

KJV 01MX0411 \$5.95  
NIV 01MX0694 \$5.95

### LFTL Junior Councilmen Accessories

Councilmen Enrollment Card 72MX8004 FREE  
LFTL Junior Councilmen Brochure 72MX8015 FREE  
LFTL Junior Councilmen Study Course 72MX8016 \$1.00

### Outpost Patrol Flags

Colorful nylon flags with seamed ends at top and bottom. Choose from a variety of designs. Suitable for 3/4" dowel rods, designed to hang on staff. See the *Royal Rangers Leader Manual, 02MX2100*, for more information about patrol systems. 10 x 14"

Antelope	08MX1080	\$10.95
Bear	08MX1081	\$10.95
Beaver	08MX1082	\$10.95
Bobcat	08MX1083	\$10.95
Elk	08MX1087	\$10.95
Fox	08MX1088	\$10.95
Gator	08MX1089	\$10.95
Owl	08MX1091	\$10.95

NEW

ROYAL RANGERS

Motto  
"READY."

Ready for anything!  
Ready to work, play,  
serve, worship, live,  
and  
OBEY GOD'S WORD.

---

Code

A Royal Ranger is:  
**ALERT  
CLEAN  
HONEST  
COURAGEOUS  
LOYAL  
COURTEOUS  
OBEDIENT  
SPIRITUAL**

ROYAL RANGERS

Pledge

With God's help, I  
will do my best to  
serve God, my church,  
and my fellowman;  
to live by the Ranger  
Code; to make the  
Golden Rule my  
daily rule.

---

The  
Golden  
Rule

In everything, do  
to others what you  
would have them  
do to you.  
**(Matthew 7:12)**

Front

Back

### Royal Rangers Bookmark

Give each boy a bookmark to help him learn and remember the Pledge, Code, Motto, and Golden Rule. 2 1/4 x 6 1/4"

13MX6750 25 for \$5.50

### God and Life

Offers exercises for students wanting to increase their faith; make responsible vocational choices; and find identity in family, church, and country. Includes a 6-section study for teens with activities. For ages 15-20. 3-hole punched.

Student Resource Packet	03MX3880	\$3.50
Counselor's Manual	03MX3870	\$3.50
Adult Mentor Packet	08MX1099	\$3.50
Medal	15MX0408	\$5.50
Pin	15MX0409	\$3.95

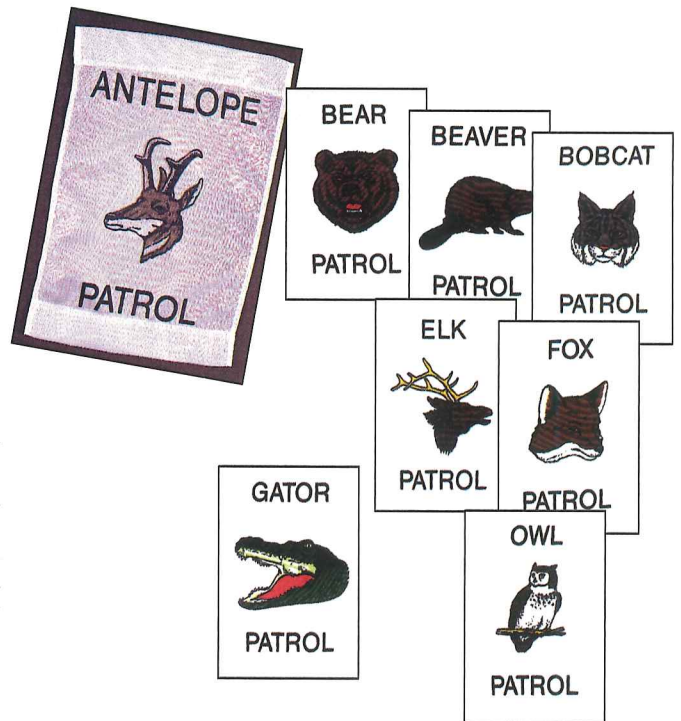

ORDER ONLINE TODAY

www.royalrangers.ag.org

## RECOGNITION & AWARDS

**NEW**



**Royal Rangers Leadership Training Academy Certificate**  
Provide your leaders with formal certificates of completion for Ranger Basics and any other training they complete. 8½ x 11"  
**06MX5309 25 for \$7.75**



**Chaplain's Cross**  
Gold-plated, military clutch. Worn by the Outpost Chaplain.  
1¼ x 1"

**15MX0171 \$5.95**



**Gold Wings Award**  
For boys and leaders who have earned their FAA private pilot's certificate or other U.S. federally recognized flight certificate.  
5/8 x 2¼"

**15MX0402 \$6.50**



**Insignias**  
Priced and sold in pairs. Military clutch.

**Outpost Councilman.** 2 bars, gold  
**Senior Commander.** 2 bars, white  
**Commander.** 2 bars, royal blue  
**Lieutenant Commander.** 1 bar, royal blue  
**Junior Commander.** 2 bars, silver

**15MX0384**  
**15MX0382**  
**15MX0380**  
**15MX0381**  
**15MX7179**

**\$4.95 each**



**NEW**



**Ranger Basics Patch**  
Awarded to leaders who have successfully completed the 8-hour Rangers Basics Leaders Training. To be worn with Class A or Class B uniforms, or with denim vests. Embroidered. 2¾ x 2¼"

**15MX7594 \$1.25**



**Leader's Medal of Achievement,**

**Gold and Blue**

Awarded to leaders who have already earned an LMA and successfully complete the Transition Training, which includes *Ranger Basics Leaders Training*. To be worn with Class A uniforms or denim vests. (Contact your district or the National Royal Rangers Office for more information on the Transition Training.)

**Medal.** Class A, B, or denim vest

**15MX7194 \$11.99**



**Ribbon.** Class A or B

**15MX7195 \$1.99**



**Leader's Medal of Achievement Patch**

To be worn with Class A or B uniforms, or denim vests. Embroidered. 2¾ x 2¼"

**15MX7593 \$1.25**



**Special Service Medal**

Given to anyone, including non-leaders and non-Royal Rangers, who have contributed outstanding service to the Royal Rangers ministry.

**Medal.** Class A, B, or denim vest

**15MX7627 \$11.99**



**Ribbon.** Class A or B

**15MX7628 \$1.99**



**Pastor's Medal**

Awarded to pastors in recognition for their support of the Royal Rangers outpost. They must meet the requirements as outlined by the National Royal Rangers Office and be approved by their district. Applications can be obtained from the national Royal Rangers web site.

**Medal.** Class A, B, or denim vest

**15MX7198 \$11.99**



**Ribbon.** Class A or B

**15MX7199 \$1.99**

**FAX TODAY**  
**1.800.328.0294**

## Restricted District Medals



### District Outstanding Service Medal

Earned by district staff who have demonstrated outstanding ability in achieving the goals of the Royal Rangers ministry.

**Medal.** Class A, B, or denim vest  
15MX7617 \$11.99

**Ribbon.** Class A or B  
15MX0630 \$1.99



### Senior Commander's Medal

Awarded to senior commanders who have demonstrated outstanding ability in achieving the goals of the Royal Rangers ministry.

**Medal.** Class A, B, or denim vest  
15MX7196 \$11.99

**Ribbon.** Class A or B  
15MX7197 \$1.99



### Outpost Commander's Medal

Earned by any commander who has demonstrated outstanding ability in achieving the goals of the Royal Rangers ministry. Can be earned yearly.

**Medal.** Class A, B, or denim vest  
15MX7640 \$11.99

**Ribbon.** Class A or B  
15MX0607 \$1.99



### Outpost Leader's Service Medal

Awarded to outpost leaders who have demonstrated outstanding service to the outpost.

**Medal.** Class A, B, or denim vest  
15MX7629 \$11.99

**Ribbon.** Class A or B  
15MX0608 \$1.99



### Silver Cluster Medal

Awarded to divisional commanders and district staff wearing the Silver Oak Leaf Insignia who have demonstrated outstanding ability in achieving the goals of the Royal Rangers ministry.

**Medal.** Class A, B, or denim vest  
15MX0487 \$9.50

**Ribbon.** Class A or B  
15MX0637 \$1.99



### Gold Cluster Medal

Awarded to sectional commanders and district staff wearing the Gold Oak Leaf Insignia who have demonstrated outstanding ability in achieving the goals of the Royal Rangers ministry.

**Medal.** Class A, B, or denim vest  
15MX0162 \$9.50

**Ribbon.** Class A or B  
15MX0638 \$1.99



### Blue Cluster Medal

Awarded to sectional staff and area commanders wearing the Blue Oak Leaf Insignia who have demonstrated outstanding ability in achieving the goals of the Royal Rangers ministry.

**Medal.** Class A, B, or denim vest  
15MX0493 \$9.50

**Ribbon.** Class A or B  
15MX0639 \$1.99

*These medals are restricted and may only be awarded and purchased by the District Royal Rangers Office. Applicants must meet the requirements as outlined by the National Royal Rangers Office and be approved by their district. Applications for most medals can be obtained from the national Royal Rangers web site.*

See pages 29–37 for additional uniforms & accessories and awards & recognition items.

All of these awards allow placement of award numerals. See page 34 for award numerals.

## TRAINING & INFORMATION

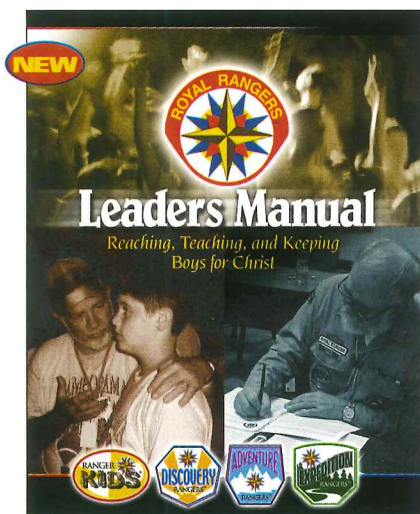

### Royal Rangers Leaders Manual

A must-have resource for all leaders. Describes the full scope of the Royal Rangers program and helps leaders understand the special needs particular to boys' ministry. Also provides detailed and practical information for establishing a complete outpost. Loose-leaf.

**With Binder**  
02MX2100 \$24.99  
**Without Binder**  
02MX2101 \$19.99  
**Binder Only, 1½"**  
08MX7078 \$6.99

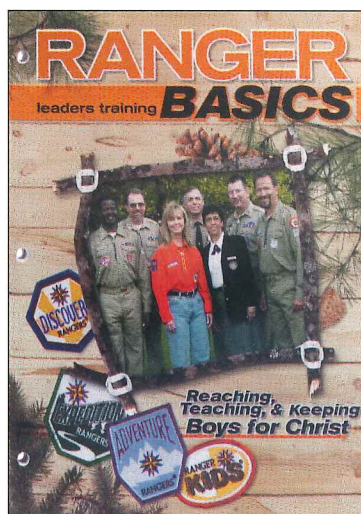

### Ranger Basics Leaders Training

An 8-hour course for all leaders, offering basic information on understanding boys, setting goals, developing a leadership team, having successful meetings, using the curriculum, leading boys to Christ, and mentoring them. Includes quizzes, self-tests, and one copy of *Preventing Child & Substance Abuse* booklet, 02MX2137. To be taught by a qualified instructor (contact your district or the National Royal Rangers Office for more information. Fill-in answers provided during classroom instruction.) Paper.

**English** 02MX2154  
**Spanish** 02MX2156  
\$8.99 each



### Organizing Your Outpost

Provides easy to follow steps for establishing and organizing a Royal Rangers outpost in your local church. Pamphlet.

72MX9021 Free  
26 or more, 15¢ ea.

### Your Outpost Council

Details the titles and responsibilities of the men who coordinate the Royal Rangers ministry in the local church. Pamphlet.

72MX9022 Free  
26 or more, 15¢ ea.

### Chartering Your Outpost

Discusses the process and benefits of registering your outpost with the district and national office. Pamphlet.

72MX9008 Free  
26 or more, 15¢ ea.

### The Ultimate

A resource to help leaders recruit boys. Talks about the Royal Rangers program and discusses how to be saved. Includes a personal invitation to attend a Royal Rangers meeting and a place to print contact information. Pamphlet.

**English** 72MX9007 Free  
26 or more, 15¢ ea.

**Spanish** 72MX9010 Free  
26 or more, 15¢ ea.

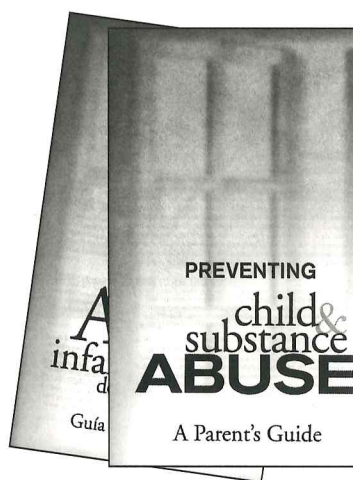

### Preventing Child and Substance Abuse: A Parent's Guide

Informational guide written to parents and their children. Discusses how children can be trained to avoid child and substance abuse and to report it if it's encountered. Included with boys' handbooks and *Ranger Basics Leaders Training*. Required reading for participation in Royal Rangers activities. Paper.

**English** 02MX2137  
**Spanish** 02MX2156

\$1.00 each  
10 or more, 85¢ each

### Our Church Heritage Packet

Includes 3 brochures: *The Assemblies of God: The Local Church*, 73MX9186; *The Assemblies of God: Our Distinctive Doctrine—The Baptism of the Holy Spirit*, 73MX9188; and *The Assemblies of God: Our 16 Doctrines*, 73MX9191. Paper.

72MX9006 \$2.50

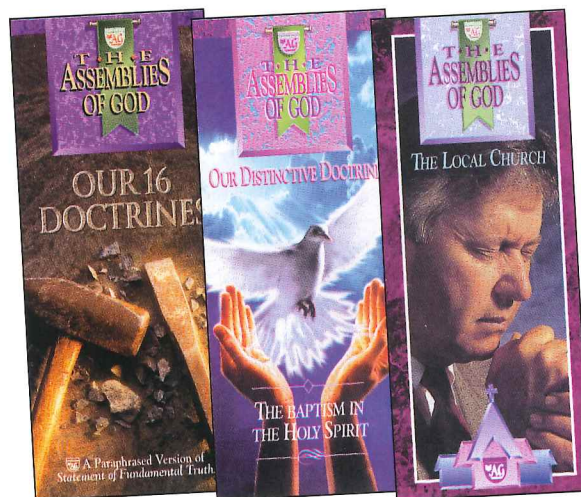

ORDER ONLINE TODAY

[www.royalrangers.ag.org](http://www.royalrangers.ag.org)

# UNIFORMS & ACCESSORIES

## Dress Blues

Single-breasted, fully lined blazers feature sewn-on epaulets, gold and silver Royal Rangers emblem, full-cut fit, and silver tone buttons. Gray trousers have slant front pockets, 2 back pockets (one buttoned), 1½" belt loops, hook closure, and a plain weave. Skirt is a modified A-line style and features single panel Shirred front, 2-panel back with kick pleat, side pockets, elastic back with zipper and button closure, and 2" hemmed bottom. All blazers are made of 55% VISA polyester/ 45% wool. These special-order items are non-refundable. Allow 4 weeks for delivery.

**Men's Navy Blazer.** Short 36-40; Reg. 36-50;

Long 40-52; X-Long 42-50

**08MX1068 \$130.00**

**Ladies' Navy Blazer.** Sizes 6-20

**08MX1069 \$130.00**

**Men's Slacks, Gray.** 65% polyester/ 35% wool

Waist sizes 29-46, unfinished hem

**08MX1070 \$50.00**

**Ladies' Skirt, Gray.** 100% polyester Sizes 6-20

**08MX1071 \$50.00**



### Dress Blues Emblem

Gold and silver. Worn on dress blazer.

**15MX6950 \$2.25**



### Ladies' Crossover Tie

Navy, button snap.

**08MX1078 \$4.95**



### Royal Rangers Tie Tac

Gold-plated with Royal Rangers emblem in color-filled baked enamel. 5/8"

**15MX0173 \$3.95**

## Leader's Navy Ties

**Redi-tie.** 18-18½" long clip on.

**Poly Repp.** 4-in-hand. 56-57" long

**Silk.** 4-in-hand. 56-57" long

**08MX0219 \$6.50**

**08MX7263 \$10.99**

**08MX7264 \$19.99**



## Royal Rangers Bolo Tie

Navy cord with gold-plated tips and adjustable, enamel-faced Royal Rangers logo. Can be worn by leaders or boys as part of the Class B uniform.

**08MX7167 \$5.99**



## Black Web Belt

Black belt with silver buckle. To be worn with dress blues. 1¼" wide.

**Size 42 08MX7217 \$3.75**

**Size 48 08MX7218 \$4.25**

**Size 60 08MX7219 \$4.75**



## Royal Rangers Tag

Embroidered tag with merrowed edge. Worn by leaders on Class A and Class B uniforms. ¾ x 4"

**15MX7200 79¢**



## Insignia

Priced and sold in pairs. Military clutches.

**Gold Star 15MX7641 \$11.50**

**Silver Eagle 15MX7644 \$9.50**

**Gold Eagle 15MX7642 \$9.50**

**Silver Oak Leaf 15MX7645 \$7.99**

**Gold Oak Leaf 15MX7643 \$7.99**

**Blue Oak Leaf 15MX7646 \$7.99**

## Royal Rangers Sectional Staff Patch

Blue with gold lettering. Worn by sectional officials.

**15MX0165 \$1.50**

## Royal Rangers District Staff Patch

Blue with gold lettering. Worn by district officials.

**15MX0164 \$1.50**

## Royal Rangers Regional Staff Patch

Blue with gold lettering. Worn by regional officials.

**15MX0156 \$1.65**



## What do I as the leader need for the Ranger Kids program?

- Ranger Kids Leaders Guide
- Ranger Kids Leaders Manual
- Royal Rangers Leaders Manual
- Ranger Kids Handbook
- Ranger Kids Workbook
- Ranger Kids Advancement Songs & Pledges CD
- Memory Verse Hand Signs Video
  - J.B. Beaver Puppet
  - Ranger Kids Poster
  - Ranger Kids Advancement Chart
  - Ranger Kids Advancement Sticker Sheets
  - Ranger Kids Advancement Certificates
  - Royal Rangers Clip Art CD
  - Royal Rangers Emblem Poster
  - Royal Rangers Code Poster
  - Royal Rangers Pledge Poster
  - Royal Rangers Motto/Golden Rule Poster

### Uniforms:

Same as boys.



## What do my boys need for the new Ranger Kids program?

- Ranger Kids Handbook
- Ranger Kids Workbook

### Class B Uniform:

- Ranger Kids Red Shirt
- Ranger Kids Bolo Tie
- Ranger Kids Group Tag (For leaders: Royal Rangers Tag)
- United States Flag Patch
- Royal Rangers Emblem Patch
- District Strip and Outpost Numeral

### Class C Uniform:

- Ranger Kids T-Shirt

### Both Class B and C Uniforms:

- Ranger Kids Cap
- Ranger Kids Blue Denim Vest
- Ranger Kids Emblem Patch
- Royal Rangers Emblem Patch

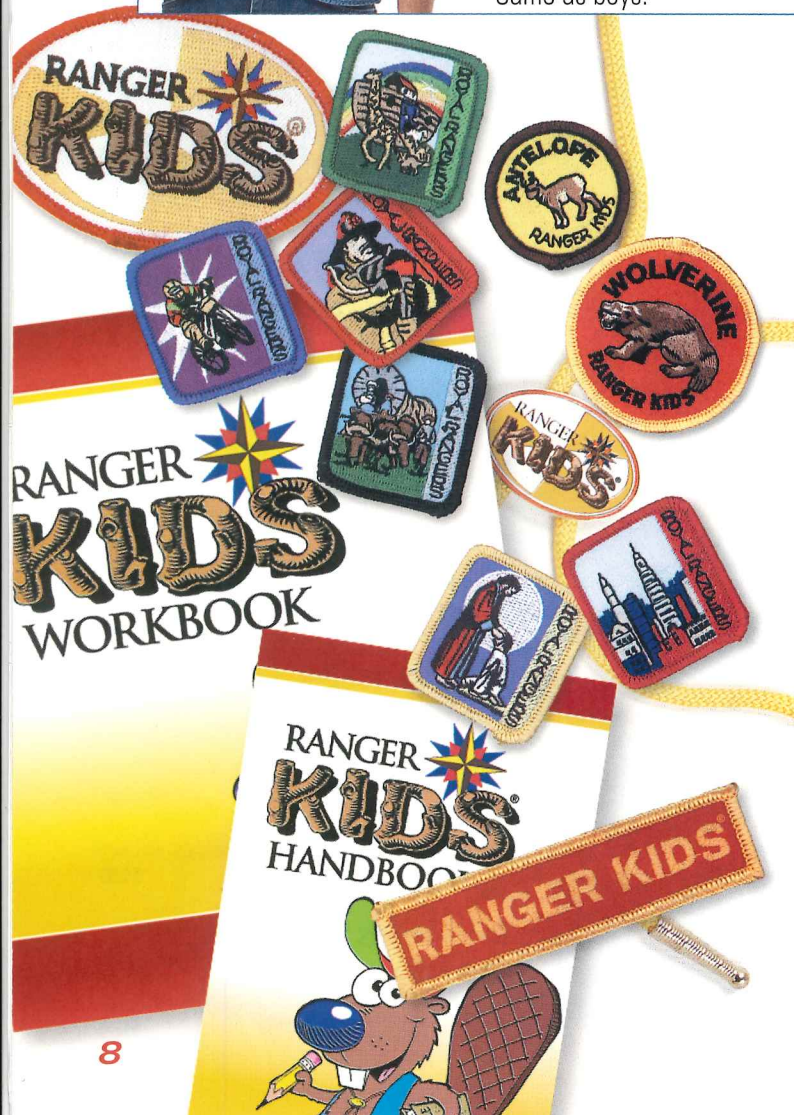

## CURRICULUM

## PROGRAM SUPPORT PRODUCTS



### Ranger Kids Leaders Guide

144 complete, 10-point lesson plans for 3 years of program material for Ranger Kids. Includes lessons, reproducible forms, plans for 12 Council of Achievement ceremonies, leadership training tips, and complete instructions for the *Ranger Kids Workbook*, 02MX2116. 3-ring binder.

**With Binder.** 3-ring binder with tabs and cover. **02MX2109 \$42.99**  
**Without Binder** **02MX2110 \$37.99**  
**Binder Only.** 2 1/2" **08MX7079 \$6.99**

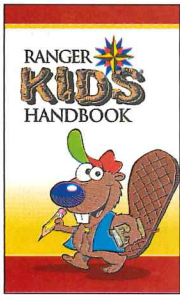

### Ranger Kids Handbook

Designed for boys and their parents. Provides uniform information and requirements and check-off lists for all trails and achievement awards. Also features a chapter summarizing the story of the Bible—a great evangelistic tool for parents who are not in the church. Includes one copy of *Preventing Child & Substance Abuse*, 02MX2137. Paper.

**02MX2115 \$4.99**

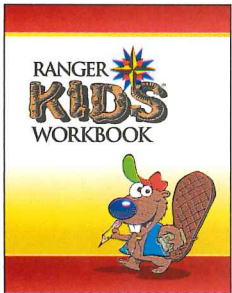

### Ranger Kids Workbook

Provides a fun, age-appropriate activity sheet for every lesson to help boys advance along all Ranger Kids trails for 3 years. Includes all 28 memory verses with hand signs and quarterly check-off pages. Activity sheets must be completed for advancement. Designed so boys who join mid-year can complete all Ranger Kids advancements.

*Some worksheets use the Braille alphabet as the code for the hidden messages. For a free Braille Alphabet Card for each of your boys, call the National Center for the Blind: 417.862.2781 ext. 1240.*

**With Binder.** 3-ring binder with tabs and cover. **02MX2116 \$9.99**  
**Without Binder** **02MX2117 \$4.99**  
**Binder Only.** 1 1/2" **08MX7078 \$6.99**

### God and Country Program

A mentoring program that encourages a positive relationship between young people and the Church. The **Adult Mentor Packet** provides an understanding of mentoring and areas of reflection in preparation for sessions with the child. It also includes a copy of the student materials. The **Counselor's Manual** features a guidance section for the mentor and additional activities for each session. Medals and pins are given for program completion, and are to be worn with the Class A or B uniforms or denim vest.

### God and Me

Helps 6- to 8-year olds learn the story of their lives, the story of Jesus' life, and how to put the 2 stories together. Features 3 projects and 3 study sections that are offered in the student manuals.

**Student Resource Packet** **08MX0249 \$3.50**  
**Counselor's Manual.** Not shown **08MX0248 \$3.50**  
**Adult Mentor Packet** **08MX1096 \$3.50**  
**Medal** **15MX0365 \$5.50**  
**Pin** **15MX0367 \$3.95**

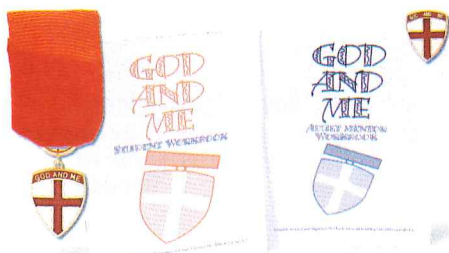

### Ranger Kids Advancement Songs & Pledges CD

A necessary resource for helping Rangers learn their advancement requirements. Includes all 9 required songs. Also features pledges, motto, code, meaning of the Royal Rangers Emblem, and all 28 Ranger Kids memory verses. Split-track and performance track.

**28MX1552 \$16.99**



### Ranger Kids Advancement Chart

Help your boys keep track of their Ranger Kids trails advancement with this full-color chart. 35 x 24"

**23MX8953 \$2.50**



### Royal Rangers Pencils

**Royal Rangers Motto.** Black pencil with Motto imprint. **16MX7196**  
**Royal Rangers Code.** Blue pencil with Code imprint **16MX7197**  
**Royal Rangers Pledge.** Red pencil with Pledge imprint **16MX7198**  
**Royal Rangers Golden Rule.** Gold pencil with Golden Rule imprint **16MX7199**

**Set of 48.** 12 of each color **26MX7200 \$14.50**

### Ranger Kids Poster

Hang up this vivid, full-color poster to identify areas used for Ranger Kids meetings. 10 x 26"

**23MX8952 \$2.50**

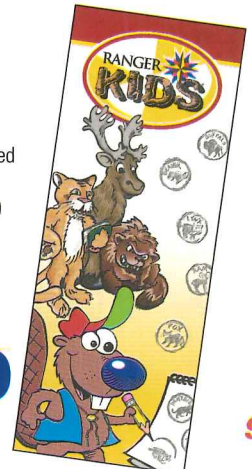

CALL TODAY  
**1.800.641.4310**

## PROGRAM SUPPORT PRODUCTS



### J.B. Beaver Puppet

This 13" Ranger Kids puppet features soft fur, detailed clothing, and an unforgettable face. Scripts are written into the Ranger Kids lessons so he can help you teach quickly and effectively.

19MX8000 \$27.99

### Ranger Kids Advancement Sticker Sheet

Use with the *Ranger Kids Advancement Chart*, 23MX8953, on mailings, and with *Ranger Kids Certificates*, 06MX5305. Sold per sheet.

Features one-inch stickers  
Self-adhesive. 3-hole punched.  
14MX7135 89¢

### Ranger Kids Emblem Sticker Sheet

Official **Ranger Kids Emblem Stickers**. Self-adhesive.  
8 per sheet. Each sticker is 3¼ x 2¼".  
14MX7131 \$1.29

NEW

### Memory Verse Hand Signs Video

A great tool for teaching your Ranger Kids hand signs for all 28 memory verse requirements. Correlates to hand signs in the *Ranger Kids Workbook*, 02MX2116. Includes booklet with verses and hand signs.

28MX1553 \$14.99



## RECOGNITION & AWARDS



### Ranger Kids Trail Patches

Rangers earn the individual trail patches when they have completed the 4 quarters of each trail. Embroidered. 2"

Elk. Kindergarten	15MX7214	99¢
Wolverine. First Grade	15MX7219	99¢
Cougar. Second Grade	15MX7224	99¢

### Ranger Kids Advancement Patches

Boys advance along the Trail each quarter and earn a patch by completing requirements listed in the *Ranger Kids Handbook* and *Ranger Kids Workbook*, 02MX2115 & 02MX2116. Requirements are integrated into the lesson plans of the *Ranger Kids Leaders Guide*, 02MX2109. Embroidered. 1½"



Antelope	15MX7210
Ram	15MX7211
Caribou	15MX7212
Buffalo	15MX7213



Beaver	15MX7215
Fox	15MX7216
Coyote	15MX7217
Badger	15MX7218



Lynx	15MX7220
Cheetah	15MX7221
Panther	15MX7222
Tiger	15MX7223



79¢ each



### 2¼" Round Patch Holder

Easily slip your patches on and off your uniform with this vinyl holder. Attaches to pocket button.

15MX7625 55¢

## Ranger Kids Achievement Patches

Boys earn achievement awards by completing requirements listed in the *Ranger Kids Handbook*, 02MX2115. Many of the criteria are integrated into the lesson plans of the *Ranger Kids Leaders Guide*, 02MX2109. Embroidered. 1½ x 1½"

## Ranger Kids Certificate of Achievement

Recognize your boys' accomplishments with this professional-looking certificate. Use them for advancements, achievements, or for any type of special recognition. Includes space for name, achievement, date, outpost church, and outpost commander. Present them in a *Sheet Protector*, 08MX0227, so boys can keep them in their workbooks. 11 x 8½"



**Sheet Protector.** Box of 100

06MX5305      25 for \$7.75  
08MX0227      \$9.95

## UNIFORMS & ACCESSORIES

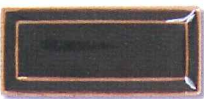

### Ranger Kids Assistant Patrol Guide Collar Bars, Single

Single green bars worn on the red shirt collar or blue denim vest by boys who are serving or have served as assistant patrol guide. One pair.

15MX7602      \$4.95

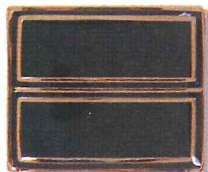

### Ranger Kids Patrol Guide Collar Bars, Double

Double green bars worn on the red shirt collar or blue denim vest by boys who are serving or have served as patrol guide. One pair.

15MX7603      \$4.95

**FAX TODAY**  
**1.800.328.0294**

	Commander's Choice Community	15MX7226
	Commander's Choice Home	15MX7227
	Commander's Choice Ministry	15MX7228
	Adventures on Wheels	15MX7229
	Arts	15MX7230
	Be a Friend	15MX7231
	Buddy Barrel	15MX7232
	Church Helper	15MX7233
	Church History	15MX7234
	Clean Body	15MX7235
	Community Helper	15MX7236
	Cooking	15MX7237
	Craft	15MX7238
	Day Camp	15MX7239
	Defender of the Word	15MX7240
	Doer of the Word	15MX7241
	Family History	15MX7242
	Firefighter	15MX7243
	Flag	15MX7244
	Games	15MX7245
	God Is Working	15MX7246
	Going Places	15MX7247
	Government	15MX7248
	Help a Neighbor	15MX7249
	Help the Commander	15MX7250
	History	15MX7251
	Home Helper	15MX7252
	In the Air	15MX7253
	Joyful Noise	15MX7254
	Keeper of the Law	15MX7255
	Light for the Lost	15MX7256
	Map	15MX7257
	Money Helper	15MX7258
	Nature	15MX7259
	Noah's Ark	15MX7260
	Old West	15MX7261
	Outing	15MX7262
	Patrol Helper	15MX7263
	Puppet	15MX7264
	Rangers about Town	15MX7265
	Safety	15MX7266
	School	15MX7267
	Sporting Event	15MX7268
	Sports	15MX7269
	Strong Body	15MX7270
	Sunday School	15MX7271
	Taking Care of God's World	15MX7272
	Telling Others about Jesus	15MX7273
	Tying Knots	15MX7274
	What's on TV	15MX7275
	Working Together	15MX7276

79¢ each

Patches pictured in alphabetical order.

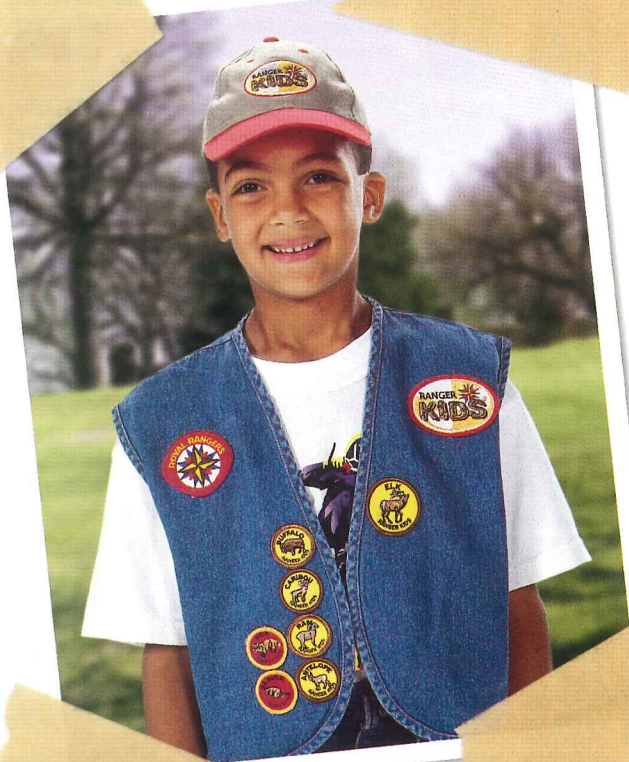

## Ranger Kids Cap

Let your boys show their excitement for Ranger Kids with this 2-toned, low-profile cap. Features velcro adjustable strap. Can be worn as part of the Class B and Class C uniforms.

<b>Youth</b>	<b>08MX7111</b>	<b>\$7.95</b>
<b>Adult</b>	<b>08MX7110</b>	<b>\$8.95</b>

## Ranger Kids Blue Denim Vest

Can be worn with Class B or Class C uniforms by boys and leaders. Blue stone-washed denim awards vest. 100% cotton. Patches worn on vest include Royal Rangers emblem, Ranger Kids emblem, advancement patches, achievement patches (can only be worn on vest), activity patches, and medals.

<b>Youth S</b>	<b>08MX0742</b>	<b>\$8.95</b>
<b>Youth M</b>	<b>08MX0743</b>	<b>\$8.95</b>
<b>Youth L</b>	<b>08MX0744</b>	<b>\$8.95</b>
<b>Youth XL. New size</b>	<b>08MX7260</b>	<b>\$8.95</b>
<b>Adult XS. New size</b>	<b>08MX7261</b>	<b>\$10.95</b>
<b>Adult S</b>	<b>08MX0745</b>	<b>\$10.95</b>
<b>Adult M</b>	<b>08MX0747</b>	<b>\$10.95</b>
<b>Adult L</b>	<b>08MX0748</b>	<b>\$10.95</b>
<b>Adult XL</b>	<b>08MX0751</b>	<b>\$10.95</b>
<b>Adult 2XL. New size</b>	<b>08MX7214</b>	<b>\$12.95</b>
<b>Adult 3XL. New size</b>	<b>08MX7215</b>	<b>\$13.95</b>
<b>Adult 4XL. New size</b>	<b>08MX7216</b>	<b>\$13.95</b>

## Ranger Kids Boys' Red Dress Shirt

Class B\* dress shirt in red poplin fabric. Pressed collar.

<b>Size 5 • Collar 11½" • Sleeve 20½"</b>	<b>08MX7095</b>	<b>\$14.50</b>
<b>Size 6 • Collar 12" • Sleeve 23"</b>	<b>08MX7096</b>	<b>\$14.50</b>
<b>Size 8 • Collar 12½" • Sleeve 24½"</b>	<b>08MX7098</b>	<b>\$14.50</b>
<b>Size 10 • Collar 13" • Sleeve 26"</b>	<b>08MX7099</b>	<b>\$14.50</b>
<b>Size 12 • Collar 13½" • Sleeve 27½"</b>	<b>08MX7100</b>	<b>\$14.50</b>
<b>Size 14 • Collar 14" • Sleeve 29½". New size</b>	<b>08MX7250</b>	<b>\$14.50</b>
<b>Size 16 • Collar 14½" • Sleeve 31½". New size</b>	<b>08MX7251</b>	<b>\$14.50</b>

## Ranger Kids Leader's Red Dress Shirt

Class B\* dress shirt in red poplin fabric. Pressed collar. Tapered tail. Includes 2 buttons on the cuff. For determining sizes when ordering for women leaders: Measure the collar and sleeve-length of a favorite shirt or blouse and order accordingly.

<b>Collar 14½" • Sleeve 32-33"</b>	<b>08MX7101</b>	<b>\$15.95</b>
<b>Collar 15½" • Sleeve 32-33"</b>	<b>08MX7103</b>	<b>\$15.95</b>
<b>Collar 15½" • Sleeve 34-35"</b>	<b>08MX7104</b>	<b>\$15.95</b>
<b>Collar 16½" • Sleeve 32-33"</b>	<b>08MX7106</b>	<b>\$15.95</b>
<b>Collar 16½" • Sleeve 34-35"</b>	<b>08MX7107</b>	<b>\$15.95</b>
<b>Collar 17½" • Sleeve 32-33"</b>	<b>08MX7108</b>	<b>\$15.95</b>
<b>Collar 17½" • Sleeve 34-35"</b>	<b>08MX7109</b>	<b>\$15.95</b>
<b>Collar 18½" • Sleeve 32-33". New size</b>	<b>08MX7252</b>	<b>\$17.95</b>
<b>Collar 18½" • Sleeve 34-35". New size</b>	<b>08MX7253</b>	<b>\$17.95</b>
<b>Collar 18½" • Sleeve 36-37". New size</b>	<b>08MX7254</b>	<b>\$17.95</b>
<b>Collar 19½" • Sleeve 32-33". New size</b>	<b>08MX7255</b>	<b>\$17.95</b>
<b>Collar 19½" • Sleeve 34-35". New size</b>	<b>08MX7256</b>	<b>\$17.95</b>
<b>Collar 19½" • Sleeve 36-37". New size</b>	<b>08MX7257</b>	<b>\$17.95</b>

\*Ranger Kids does not have a Class A uniform; however, Ranger Kids leaders may wear the standard khaki Class A for leader's events. See page 30.



**FAX TODAY**  
**1.800.328.0294**

## Ranger Kids Group Tag

Embroidered tag designating boy's placement in Ranger Kids. Worn on Class B uniforms.  
 $\frac{7}{8}$  x 4"

15MX7209 79¢



## Ranger Kids Bolo Tie

Yellow cord bolo tie with gold-plated tips and adjustable, enamel-faced Ranger Kids logo.  
 Part of the Class B uniform. Can be worn by leaders or boys.

08MX7112 \$5.99

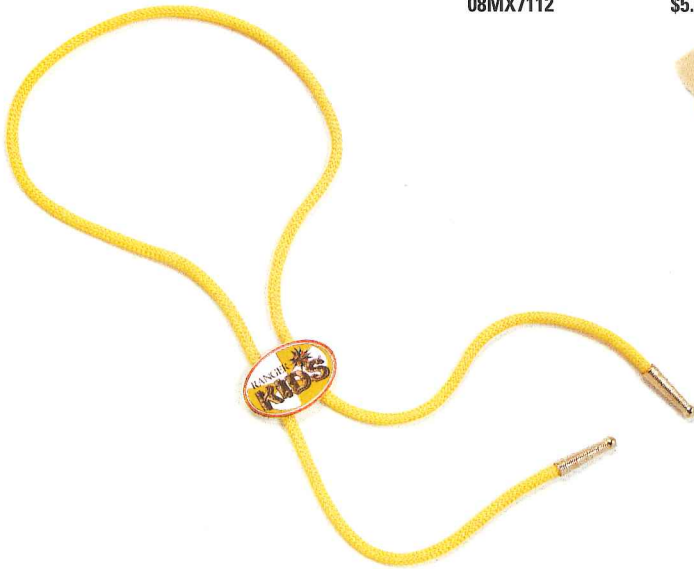

## Ranger Kids Emblem Patch

Worn on the blue denim vest. Official Ranger Kids emblem. Embroidered.  
 $3\frac{3}{4}$  x  $2\frac{1}{4}$ "

15MX7208 \$1.25

## Patch Attach

This permanent glue quickly bonds patches to practically any fabric without sewing. Ironing required. Washable and non-toxic.  
 Note: patches may be removed by reapplying heat, but glue will remain on fabric.

08MX5734 \$3.50



## Ranger Kids T-Shirt

Part of the Class C uniform. 100% heavyweight preshrunk cotton.

Youth XS	08MX7084	\$7.99
Youth S	08MX7085	\$7.99
Youth M	08MX7086	\$7.99
Youth L	08MX7097	\$7.99
Adult S	08MX7087	\$8.99
Adult M	08MX7088	\$8.99
Adult L	08MX7089	\$8.99
Adult XL	08MX7090	\$8.99
Adult 2XL	08MX7091	\$9.99
Adult 3XL	08MX7092	\$12.50
Adult 4XL	08MX7093	\$16.50

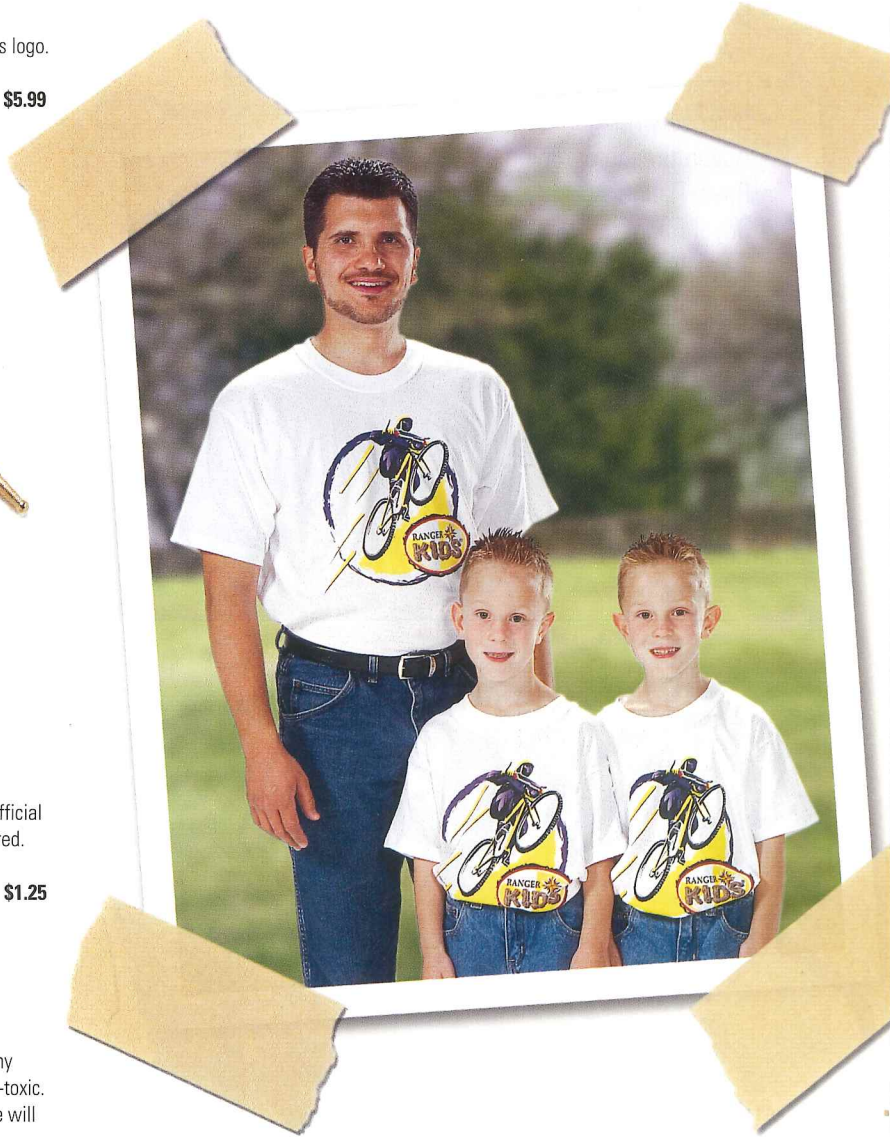

See pages 29-37 for additional uniforms & accessories and awards & recognition items.

ORDER ONLINE TODAY  
[www.royalrangers.ag.org](http://www.royalrangers.ag.org)

## What do I as the leader need for the new Discovery Rangers program?

- Discovery Rangers Leaders Guide
- Leaders Red Merits Reference
- Leaders Blue Merits Reference
- Royal Rangers Leaders Manual
- Discovery Rangers Handbook
- Discovery Rangers Workbook
- Discovery Rangers Poster
- Discovery Rangers Advancement Chart
- Discovery Rangers Sticker Sheets
- Discovery Rangers Certificates
- Adventures in Camping
- Royal Rangers Clip Art CD
- Royal Rangers Emblem Poster
- Royal Rangers Code Poster
- Royal Rangers Pledge Poster
- Royal Rangers Motto/Golden Rule Poster

### Uniforms:

Same as boys.

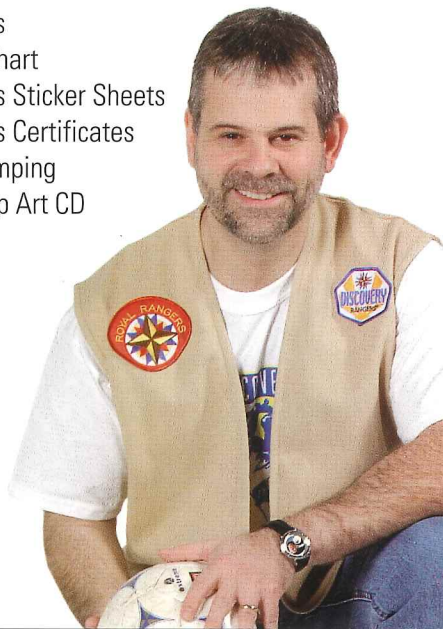

## What do my boys need for the new Discovery Rangers program?

- Discovery Rangers Handbook
- Discovery Rangers Workbook
- Adventures in Camping

### Class A Uniform:

- Khaki Uniform
- Group Tie (For leaders: Leader's Tie)
- United States Flag Patch
- Group Tag (For leaders: Royal Rangers Tag)
- District Strip and Outpost Numeral

### Class B Uniform:

- Same as Class A except Group Bolo Tie

### Class C Uniform:

- Group Cap (Can also be worn on Class B uniforms)
- Group T-Shirt

- Group Vest:** (Can also be worn with Class A, B, and C uniforms)
- Group Emblem Patch
  - Royal Rangers Emblem Patch

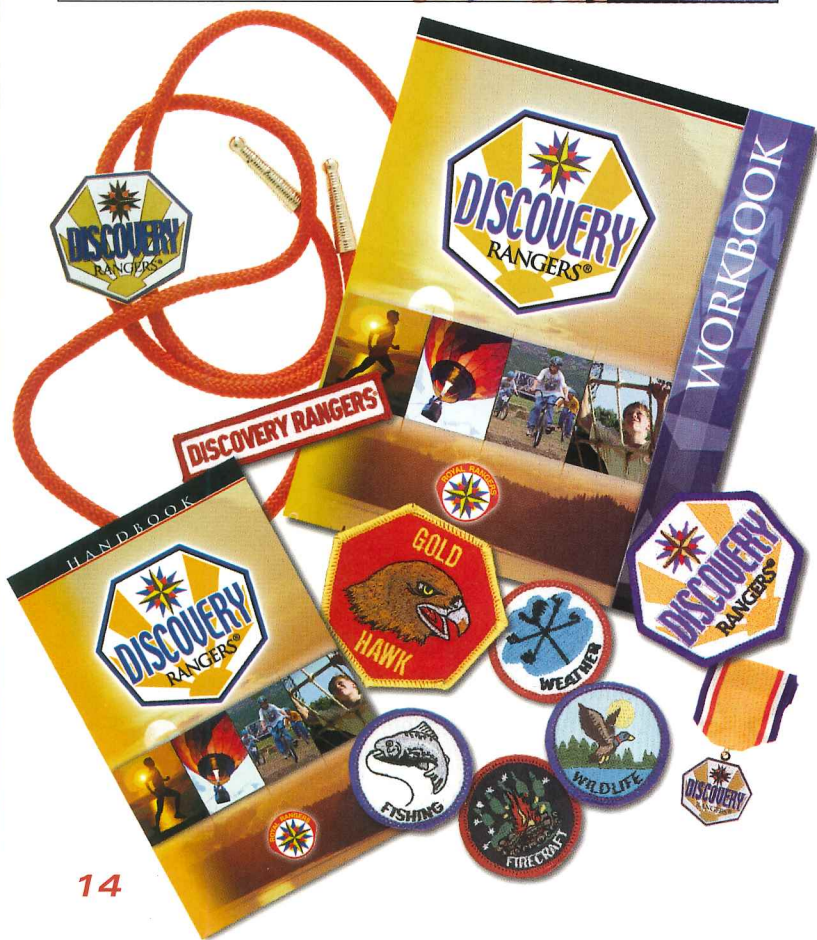

## CURRICULUM

**NEW**

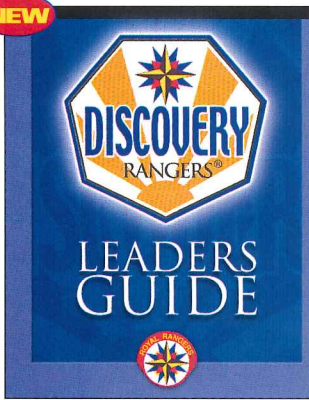

### Discovery Rangers Leaders Guide

144 complete, 10-point lesson plans for 3 years of program material for Discovery Rangers. Includes lessons, reproducible forms, plans for 12 Council of Achievement ceremonies, leadership training tips, and complete lesson plans for 24 Bible merits.

<b>With Binder.</b> 3-ring binder with tabs and cover.		
	<b>02MX2120</b>	<b>\$42.99</b>
<b>Without Binder</b>		
	<b>02MX2121</b>	<b>\$37.99</b>
<b>Binder Only.</b> 2½"		
	<b>08MX7079</b>	<b>\$6.99</b>

**NEW**

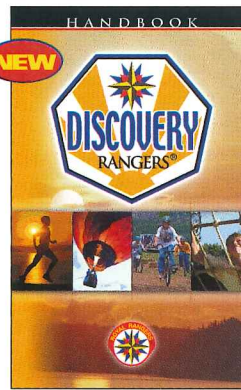

### Discovery Rangers Handbook

Explains the program and Advancement Trail from Recruit through Gold Eagle Medalist. Details how the boys should wear their uniform and how the patrol system works. Provides requirements for all red and blue merits. Includes the *Preventing Child and Substance Abuse* booklet, 02MX2137. Paper.

**02MX2126** **\$6.99**



### Royal Rangers Leaders Red and Blue Merits References

Contains the merit lesson plans and resources to be used in support of the "Program Feature" in the *Discovery Rangers Leaders Guide*, 02MX2120. Also includes an overview and answer guide for every merit. Loose-leaf.

<b>Red Merits Reference</b>	<b>02MX2129</b>	<b>\$19.99</b>
<b>Blue Merits Reference</b>	<b>02MX2130</b>	<b>\$19.99</b>

**NEW**

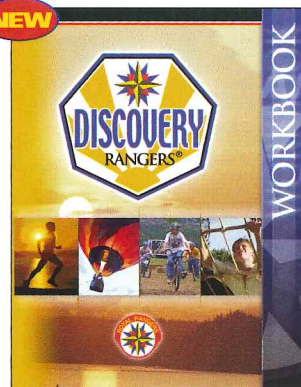

### Discovery Rangers Workbook

Orange, Red, and Blue sections include every required and elective merit for the Discovery Rangers Advancement Trail. Provides Bible stories and activities for fulfilling merit requirements. Commander's sign-off section serves as a detailed record of merit completion.

<b>With Binder.</b> 3-ring binder with tabs and cover.		
	<b>02MX2127</b>	<b>\$14.99</b>
<b>Without Binder</b>		
	<b>02MX2128</b>	<b>\$9.99</b>
<b>Binder Only.</b> 1½"		
	<b>08MX7078</b>	<b>\$6.99</b>

### God and Country Program

A mentoring program that encourages a positive relationship between young people and the Church. The **Adult Mentor Packet** provides an understanding of mentoring and areas of reflection in preparation for sessions with the child. It also includes a copy of the student materials. The **Counselor's Manual** features a guidance section for the mentor and additional activities for each session. Medals and pins are given for program completion, and are to be worn with the Class A or B uniforms or tan denim vest.

### God and Family

Offers 6 sessions that encourage Christian nurturing in the home and church. Examines God and family, friends, future, and other areas. For ages 9–10. 3-hole punched.

<b>Student Resource Packet</b>	<b>08MX0234</b>	<b>\$3.50</b>
<b>Counselor's Manual</b>	<b>08MX0233</b>	<b>\$3.50</b>
<b>Adult Mentor Packet</b>	<b>08MX1097</b>	<b>\$3.50</b>
<b>Medal</b>	<b>15MX0404</b>	<b>\$5.50</b>
<b>Pin</b>	<b>15MX0405</b>	<b>\$3.95</b>



**CALL TODAY**  
**1.800.641.4310**



## PROGRAM SUPPORT PRODUCTS & RECOGNITION



### Discovery Rangers Certificate of Achievement

Recognize your boys' accomplishments with this professional-looking certificate. Use them for advancements, achievements, or for any type of special recognition. Includes space for name, achievement, date, outpost church, and outpost commander. Present them in a *Sheet Protector*, 08MX0227, so boys can keep them in their workbooks. 11 x 8½"

06MX5306 25 for \$7.75  
08MX0227 \$9.95

Sheet Protector. Box of 100

### Discovery Rangers Advancement Chart

Help your boys keep track of their Discovery Rangers Trails advancement with this full-color chart. 35 x 24"

23MX8955 \$2.50

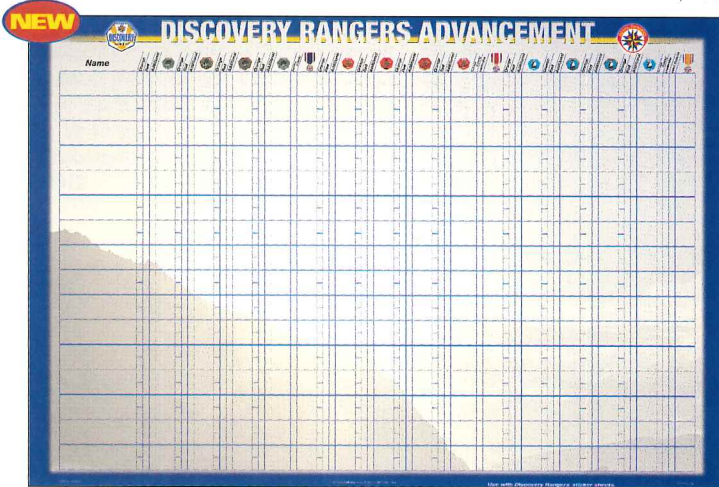

### Royal Rangers Pencils

**Royal Rangers Motto.** Black pencil with Motto imprint.

**Royal Rangers Code.** Blue pencil with Code imprint

**Royal Rangers Pledge.** Red pencil with Pledge imprint

**Royal Rangers Golden Rule.** Gold pencil with Golden Rule imprint

12 for \$3.99

16MX7196  
16MX7197  
16MX7198  
16MX7199

Set of 48. 12 of each color

16MX7200 \$14.50

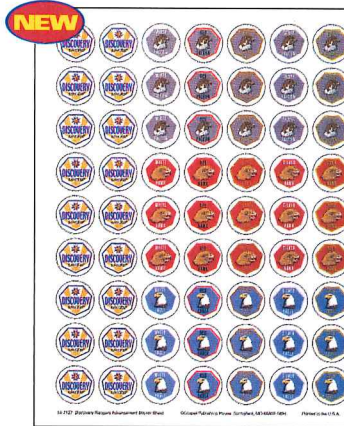

### Discovery Rangers Advancement Sticker Sheet

Use with the *Discovery Rangers Advancement Chart*, 23MX8955, on mailings, and with *Discovery Rangers Advancement Certificates*, 06MX5306. Features 63 one-inch stickers. Includes 18 Discovery Rangers emblems and 3 each of advancement award designs. Self-adhesive. Sold per sheet. 3-hole punched.

14MX7127 89¢

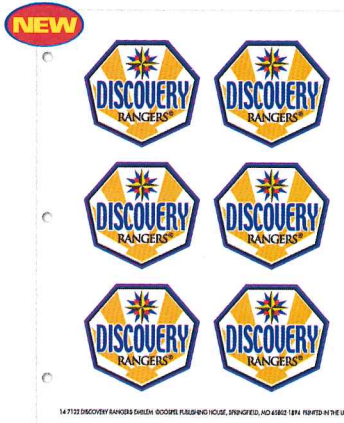

### Discovery Rangers Emblem Sticker

Official **Discovery Rangers Emblem Stickers**. Self-adhesive. 6 per sheet. Each sticker is 3 x 2½".

14MX7132 \$1.29

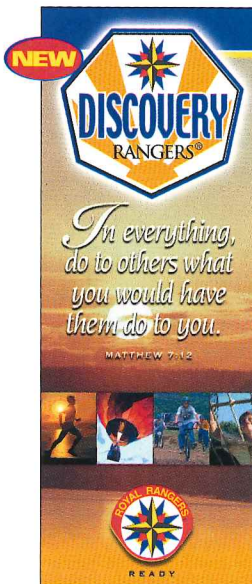

### Discovery Rangers Poster

Hang up this vivid, full-color poster to identify areas used for Discovery Rangers meetings. 10 x 26"

23MX8954 \$2.50

ORDER ONLINE TODAY  
[www.royalrangers.ag.org](http://www.royalrangers.ag.org)

## ADVANCEMENT TRAILS

### Discovery Rangers Trail Medals

Awarded to boys who have earned all 4 quarter Trail patches and completed additional requirements.

<b>Gold Falcon Medal.</b> Class A, B, or tan denim vest	<b>15MX7281</b>	<b>\$11.99</b>
<b>Gold Hawk Medal.</b> Class A, B, or tan denim vest	<b>15MX7287</b>	<b>\$11.99</b>
<b>Gold Eagle Medal.</b> Class A, B, or tan denim vest	<b>15MX7293</b>	<b>\$11.99</b>
<b>Gold Falcon Medal Ribbon.</b> Class A or B	<b>15MX7282</b>	<b>\$1.99</b>
<b>Gold Hawk Medal Ribbon.</b> Class A or B	<b>15MX7288</b>	<b>\$1.99</b>
<b>Gold Eagle Medal Ribbon.</b> Class A or B	<b>15MX7294</b>	<b>\$1.99</b>
<b>Gold Falcon Patch</b>	<b>15MX7280</b>	<b>99¢</b>
<b>Gold Hawk Patch</b>	<b>15MX7286</b>	<b>99¢</b>
<b>Gold Eagle Patch</b>	<b>15MX7292</b>	<b>99¢</b>



### Discovery Rangers Advancement Patches

Boys advance along the Trail each quarter and earn a patch by completing requirements listed in the *Discovery Rangers Handbook* and *Discovery Rangers Workbook*, 02MX2126 & 02MX2127. Requirements are integrated into the lesson plans of the *Discovery Rangers Leaders Guide*, 02MX2120. Embroidered. 2 1/2" x 2 1/2"

<b>White Falcon</b>	<b>15MX7277</b>	<b>99¢</b>
<b>Red Falcon</b>	<b>15MX7608</b>	<b>99¢</b>
<b>Bronze Falcon</b>	<b>15MX7278</b>	<b>99¢</b>
<b>Silver Falcon</b>	<b>15MX7279</b>	<b>99¢</b>
<b>White Hawk</b>	<b>15MX7283</b>	<b>99¢</b>
<b>Red Hawk</b>	<b>15MX7609</b>	<b>99¢</b>
<b>Bronze Hawk</b>	<b>15MX7284</b>	<b>99¢</b>
<b>Silver Hawk</b>	<b>15MX7285</b>	<b>99¢</b>
<b>White Eagle</b>	<b>15MX7289</b>	<b>99¢</b>
<b>Red Eagle</b>	<b>15MX7610</b>	<b>99¢</b>
<b>Bronze Eagle</b>	<b>15MX7290</b>	<b>99¢</b>
<b>Silver Eagle</b>	<b>15MX7291</b>	<b>99¢</b>



## UNIFORMS & ACCESSORIES

### Discovery Rangers Cap

Let your boys show their excitement for Discovery Rangers with this 2-toned, low-profile cap. Features velcro adjustable strap. Can be worn as part of the Class B and Class C uniforms.

08MX7129

\$9.99



### Discovery Rangers Emblem Patch

Worn on the tan denim vest. Official Discovery Rangers emblem. Embroidered. 3 x 2 1/2"

15MX7295

\$1.25



### Discovery Rangers Group Tag

Embroidered tag designating boy's placement in Discovery Rangers. Worn on Class A and B uniforms. 7/8 x 4"

15MX7297

79¢



### Patch Attach

This permanent glue quickly bonds patches to practically any fabric without sewing. Ironing required. Washable and non-toxic. Note: patches may be removed by reapplying heat, but glue will remain on fabric.

08MX5734

\$3.50



### 3 3/8" Round Patch Holder

Easily slip your patches on and off your uniform with this vinyl holder. Attaches to pocket button.

15MX7626

55¢



### Discovery Rangers Assistant Patrol Guide Collar Bars, Single

Single red bars worn on the khaki shirt collar or tan denim vest by boys who are serving or have served as assistant patrol guide. One pair.

15MX7611

\$4.95



### Discovery Rangers Patrol Guide Collar Bars, Double

Double red bars worn on the khaki shirt collar or tan denim vest by boys who are serving or have served as patrol guide. One pair.

15MX7612

\$4.95



### Discovery Rangers Senior Patrol Guide Collar Bars, Triple

Triple red bars worn on the khaki shirt collar or tan denim vest by boys who are serving or have served as senior patrol guide. One pair.

15MX7613

\$4.95

FAX TODAY  
**1.800.328.0294**

## Red Redi-Tie

Red, redi-tie. Boys size. Part of the Class A uniform. 12½"

08MX0215

\$6.50



## Royal Rangers Tie Tac

Gold-plated with Royal Rangers emblem in color-filled baked enamel.

15MX0173

\$3.95



## Discovery Rangers Bolo Tie

Red cord bolo tie with gold-plated tips and adjustable, enamel-faced Discovery Rangers logo. Can be worn by boys or leaders as part of the Class B uniform.

08MX7132

\$5.99

## Discovery Rangers T-Shirt

Part of the Class C uniform. 100% heavyweight preshrunk cotton.

Youth M	08MX7120	\$7.99
Youth L	08MX7121	\$7.99
Adult S	08MX7122	\$8.99
Adult M	08MX7123	\$8.99
Adult L	08MX7124	\$8.99
Adult XL	08MX7125	\$8.99
Adult 2XL	08MX7126	\$9.99
Adult 3XL	08MX7127	\$12.50
Adult 4XL	08MX7128	\$16.50

See pages 29-37 for additional uniforms & accessories and awards & recognition items.



## What do I as the leader need for the new Adventure Rangers program?

- Adventure Rangers Leaders Guide
- Leaders Gold Merits Reference
- Leaders Green Merits Reference
- Royal Rangers Leaders Manual
- Adventure Rangers Handbook
- Adventure Rangers Workbook
- Adventure Rangers Poster
- Adventure Rangers Advancement Chart
- Adventure Rangers Sticker Sheets
- Adventure Rangers Certificates
- Adventures in Camping
- Royal Rangers Clip Art CD
- Royal Rangers Emblem Poster
- Royal Rangers Code Poster
- Royal Rangers Pledge Poster
- Royal Rangers Motto/ Golden Rule Poster

### Uniforms:

Same as boys.

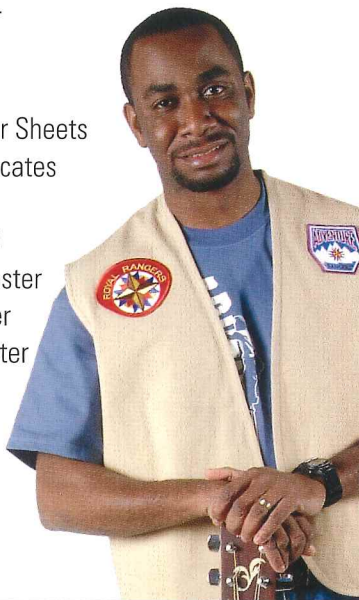

## What do my boys need for the new Adventure Rangers program?

- Adventure Rangers Handbook
- Adventure Rangers Workbook
- Adventures in Camping

### Class A Uniform:

- Khaki Uniform
- Group Tie (For leaders: Leader's Tie)
- United States Flag Patch
- Group Tag (For leaders: Royal Rangers Tag)
- District Strip and Outpost Numeral

### Class B Uniform:

- Same as Class A except Group Bolo Tie

### Class C Uniform:

- Group Cap (Can also be worn with Class B uniforms)
- Group T-Shirt

### Group Vest: (Can also be worn with Class A, B, and C uniforms)

- Group Emblem Patch
- Royal Rangers Emblem Patch



## CURRICULUM

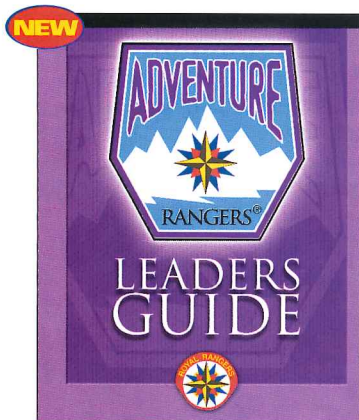

### Adventure Rangers Leaders Guide

144 complete, 10-point lesson plans for 3 years of program material for Adventure Rangers. Includes lessons, reproducible forms, plans for 12 Council of Achievement ceremonies, leadership training tips, and complete lesson plans for 24 Bible merits.

<b>With Binder.</b> 3-ring binder with tabs and cover.		
	<b>02MX2132</b>	<b>\$42.99</b>
<b>Without Binder</b>	<b>02MX2133</b>	<b>\$37.99</b>
<b>Binder Only.</b> 2 1/2"	<b>08MX7079</b>	<b>\$6.99</b>

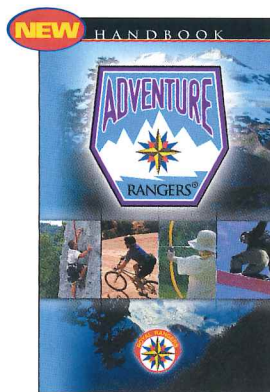

### Adventure Rangers Handbook

Explains the program and Advancement Trail from Recruit through the Gold Medal of Achievement. Details how the boys should wear their uniform and how the patrol system works. Provides requirements for all gold and green merits. Includes the *Preventing Child and Substance Abuse* booklet, 02MX2137. Paper.

**02MX2136** **\$9.99**

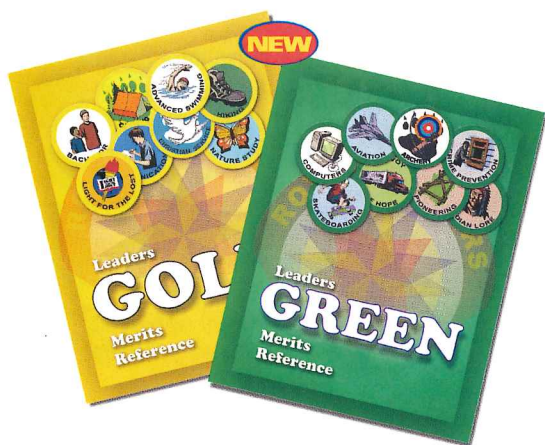

### Royal Rangers Leaders Gold and Green Merits References

Contains the merit lesson plans and resources to be used in support of the "Program Feature" in the *Adventure Rangers Leaders Guide*, 02MX2132. Also includes an overview and answer guide for every merit. Loose-leaf.

<b>Gold Merits Reference</b>	<b>02MX2134</b>	<b>\$19.99</b>
<b>Green Merits Reference</b>	<b>02MX2135</b>	<b>\$29.99</b>

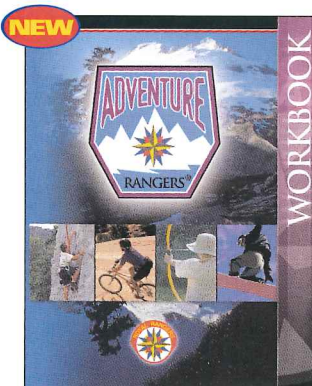

### Adventure Rangers Workbook

Brown, gold, and green sections include every required and elective merit for the Adventure Rangers Advancement Trail. Provides Bible stories and activities for fulfilling merit requirements. Commander's sign-off section serves as a detailed record of merit completion.

<b>With Binder.</b> 3-ring binder with tabs and cover.		
	<b>02MX2138</b>	<b>\$19.99</b>
<b>Without Binder</b>	<b>02MX2139</b>	<b>\$14.99</b>
<b>Binder Only.</b> 2 1/2"	<b>08MX7079</b>	<b>\$6.99</b>

### Adventure Rangers Gold Medal of Achievement Orange and Red Required Merits Pack (NOT SHOWN)

This packet is for a boy who has joined Adventure Rangers but didn't go through the *Discovery Rangers Workbook*, 02MX2127. It allows him to complete the required Gold Medal of Achievement merits that are normally earned in *Discovery Rangers*. Paper.

**02MX2099** **\$4.99**

CALL TODAY  
**1.800.641.4310**

### God and Country Program

A mentoring program that encourages a positive relationship between young people and the Church. The **Adult Mentor Packet** provides an understanding of mentoring and areas of reflection in preparation for sessions with the child. It also includes a copy of the student materials. The **Counselor's Manual** features a guidance section for the mentor and additional activities for each session. Medals and pins are given for program completion, and are to be worn with the Class A or B uniforms or tan denim vest.

### God and Church

Provides an opportunity to get to know the pastor and counselor on a more personal basis. Helps boys understand their church's structure, objectives, and mission. Student Resource Packet is divided into 2 sections: *God and His Work* and *Christians and Their Work*. For ages 11-14. 3-hole punched.

<b>Student Resource Packet</b>	<b>08MX0236</b>	<b>\$3.50</b>
<b>Counselor's Manual</b>	<b>08MX0235</b>	<b>\$3.50</b>
<b>Adult Mentor Packet</b>	<b>08MX1098</b>	<b>\$3.50</b>
<b>Medal</b>	<b>15MX0406</b>	<b>\$5.50</b>
<b>Pin</b>	<b>15MX0407</b>	<b>\$3.95</b>



## PROGRAM SUPPORT PRODUCTS & RECOGNITION

**NEW**



### Adventure Rangers Certificate of Achievement

Recognize your boys' accomplishments with this professional-looking certificate. Use them for advancements, achievements, or for any type of special recognition. Includes space for name, achievement, date, outpost church, and outpost commander. Present them in a *Sheet Protector*, 08MX0227, so boys can keep them in their workbooks. 11 x 8½"

06MX5307 25 for \$7.75  
08MX0227 \$9.95

Sheet Protector. Box of 100

### Adventure Rangers Advancement Chart

Help your boys keep track of their Adventure Rangers Trails advancement with this full-color chart. 35 x 24"

23MX8957 \$2.50

**NEW**

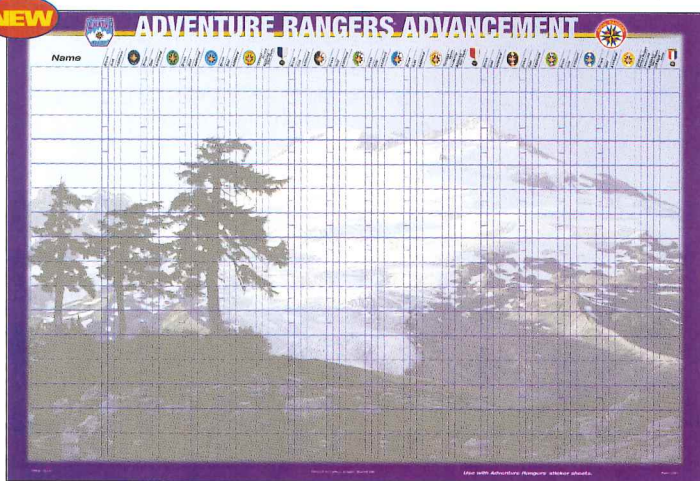

### Royal Rangers Pencils

**Royal Rangers Motto.** Black pencil with Motto imprint.

**Royal Rangers Code.** Blue pencil with Code imprint

**Royal Rangers Pledge.** Red pencil with Pledge imprint

**Royal Rangers Golden Rule.** Gold pencil with Golden Rule imprint

12 for \$3.99

16MX7196

16MX7197

16MX7198

16MX7199

Set of 48. 12 of each color

16MX7200

\$14.50



**NEW**



### Adventure Rangers Advancement Sticker Sheet

Use with the *Adventure Rangers Advancement Chart*, 23MX8957; on mailings; and with *Adventure Rangers Certificates of Achievement*, 06MX5307. Features 63 one-inch stickers. Includes 18 Adventure Rangers emblems and 3 each of advancement award designs. Self-adhesive. Sold per sheet. 3-hole punched.

14MX7128

89¢

**NEW**



### Adventure Rangers Emblem Sticker

Official **Adventure Rangers Emblem Stickers**. Self-adhesive. 6 per sheet. Each sticker is 3 x 2½"

14MX7133

\$1.29

**NEW**

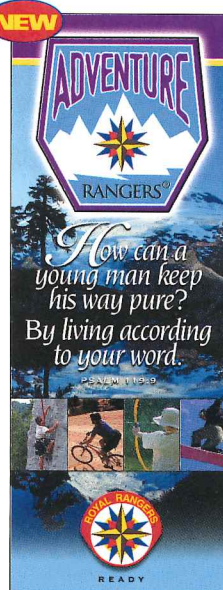

### Adventure Rangers Poster

Hang up this vivid, full-color poster to identify areas used for Adventure Rangers meetings. 10 x 26"

23MX8956

\$2.50

ORDER ONLINE TODAY  
[www.royalrangers.ag.org](http://www.royalrangers.ag.org)

## ADVANCEMENT TRAILS

### Restricted National Medals

#### Adventure Rangers Trail Medals

Awarded to boys who have earned all 4 quarter Trail patches and completed additional requirements.



**Bronze Medal.** Class A or B  
15MX7302 \$11.99

**Bronze Medal Ribbon.** Class A or B  
15MX7303 \$1.99



**Bronze Patch** 15MX7301 99¢



**Silver Medal.** Class A or B  
15MX7308 \$11.99

**Silver Medal Ribbon.** Class A or B  
15MX7309 \$1.99



**Silver Patch** 15MX7307 99¢

*These awards are restricted and may only be awarded and purchased with the approval of the National Royal Rangers Office. Applicants must meet the requirements as outlined by the National Royal Rangers Office and be approved by the National Office. Applications can be obtained from the national Royal Rangers web site.*

#### Adventure Rangers Advancement Patches

Boys advance along the Trail each quarter and earn a patch by completing requirements listed in the *Adventure Rangers Handbook* and *Adventure Rangers Workbook*, 02MX2136 & 02MX2138. Requirements are integrated into the lesson plans of the *Adventure Rangers Leaders Guide*, 02MX2132. Embroidered. 2 1/2 x 2"

<b>Powder Horn</b>	15MX7298	99¢
<b>Bowie Knife</b>	15MX7299	99¢
<b>Tomahawk</b>	15MX7604	99¢
<b>Long Rifle</b>	15MX7300	99¢



<b>Pine</b>	15MX7304	99¢
<b>Cedar</b>	15MX7305	99¢
<b>Oak</b>	15MX7605	99¢
<b>Sequoia</b>	15MX7306	99¢



<b>Second Class</b>	15MX7606	99¢
<b>First Class</b>	15MX7310	99¢
<b>Advance</b>	15MX7311	99¢
<b>Master</b>	15MX7312	99¢



### Restricted District Awards

#### Gold Buffalo Award

Rangers can continue to earn Gold Buffalo Pins for every 6 additional merits they complete after receiving their Gold Medal of Achievement.



#### Gold Buffalo Pin

Gold-finish Medal of Achievement Award pin with clutch clasp. Worn on drape of Gold Medal of Achievement.  
3/8 x 5/8"

15MX0276 \$1.75



#### Gold Buffalo Star

Worn on Gold Medal of Achievement Ribbon.

15MX0774 99¢

*These awards are restricted and may only be awarded and purchased by the District Royal Rangers Office. Applicants must meet the requirements as outlined by the National Royal Rangers Office and be approved by their district. Applications can be obtained from the national Royal Rangers web site.*



## UNIFORMS & ACCESSORIES

### Adventure Rangers Cap

Let your boys show their excitement for Adventure Rangers with this 2-toned, low-profile cap. Features velcro adjustable strap. Worn as part of the Class B and Class C uniforms.

08MX7150 \$9.99



### Adventure Rangers Emblem Patch

Worn on the tan denim vest. Official Adventure Rangers emblem. Embroidered. 3 x 2 1/2"

15MX7316 \$1.25



### Adventure Rangers Group Tag

Embroidered tag designating boy's placement in Adventure Rangers. Worn on Class A and B uniforms. 7/8 x 4"

15MX7318 79¢



### Patch Attach

This permanent glue quickly bonds patches to practically any fabric without sewing. Ironing required. Washable and non-toxic. Note: patches may be removed by reapplying heat, but glue will remain on fabric.

08MX5734 \$3.50



### 3/8" Round Patch Holder

Easily slip your patches on and off your uniform with this vinyl holder. Attaches to pocket button.

15MX7626 55¢



### Adventure Rangers Assistant Patrol Guide Collar Bars, Single

Single gold bars worn on the khaki shirt collar or tan denim vest by boys who are serving or have served as assistant patrol guide. One pair.

15MX0728 \$4.95

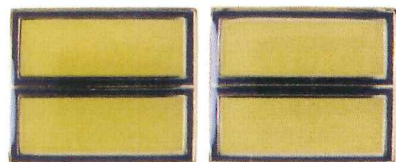

### Adventure Rangers Patrol Guide Collar Bars, Double

Double gold bars worn on the khaki shirt collar or tan denim vest by boys who are serving or have served as patrol guide. One pair.

15MX0729 \$4.95

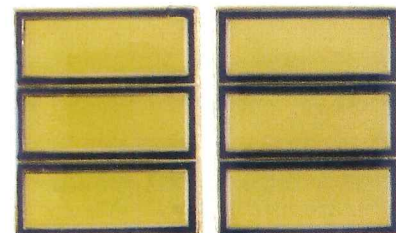

### Adventure Rangers Senior Patrol Guide Collar Bars, Triple

Triple gold bars worn on the khaki shirt collar or tan denim vest by boys who are serving or have served as senior patrol guide. One pair.

15MX0735 \$4.95

## In a Hurry?

Ordering online is as easy as 1, 2, 3.

1. Select Order Direct at the Royal Rangers Store at [www.royalrangers.ag.org](http://www.royalrangers.ag.org).
2. Insert any item or quantity into the blank order form.
3. Submit your order.

# Ordering Instructions



## ORDER BY PHONE OR FAX

Toll free: 1-800-641-4310 (\$5.00 minimum). Our toll-free phone lines are open Monday through Friday from 7:00 a.m. to 6:30 p.m., Central Standard Time. For orders of less than \$5.00 placed through our toll-free number, a \$1.00 service charge is added to the order. Our U.S. fax number is 1-800-328-0294 (\$5 minimum). Our international fax is 417-862-5881. Due to the volume of faxes received, we are unable to confirm the receipt of fax orders. To prevent duplicate orders, please do not send confirmation orders. Before you call or fax, please help us process your order more efficiently by following these guidelines:

- Write out your order in its entirety, including the 8-digit item numbers. Example: 02WA0883.
  - Please give your account number, name, daytime telephone number, and purchase order number (if applicable).
  - If you are using VISA, MasterCard, or Discover, please give your credit card number, expiration date, and cardholder's name and address.
- From the date we receive your order it is usually processed and shipped within 3 working days.  
See Shipping Information for delivery time.

## ORDER BY MAIL

For mail orders, use the order form provided in this catalog.

- Clearly print your account number, name, complete address, daytime telephone number and area code, and purchase order number (if applicable).
- If you are using a credit card, please SIGN the order form where indicated and supply your card's complete number, expiration date, and cardholder's name and address.
- Be sure to fill in the quantity, 8-digit item number, name

## 100% GUARANTEE

**We guarantee your satisfaction with every item in this catalog. If for any reason you are dissatisfied with a purchase, adjustment will be made promptly. Please read RETURN PROCEDURES elsewhere on this page. Recordings, cassettes, videos, special order items, and items advertised as non-refundable are exceptions and cannot be returned unless they are defective.**

[www.RoyalRangers.ag.org](http://www.RoyalRangers.ag.org)

**1.800.641.4310**  
CALL TOLL FREE  
(\$5 MINIMUM ORDER)

**US FAX**  
1.800.328.0294

**INTERNATIONAL FAX**  
417.862.5881



of item, and price for each item ordered. Add postage and handling charges, and add state sales tax where applicable.

- First Class mail takes up to 5 working days to reach Gospel Publishing House. Please calculate this amount of time plus the order processing and shipping time into your expected date of receiving your order.
- Accuracy is important, so double-check your order to be sure all the information is correct and complete.
- Additional order forms will be sent upon request. You will automatically receive a new order form in your package(s) when you place an order from this catalog. See Shipping Information for delivery time.

## ORDER BY INTERNET

Our secure web site is located at [www.royalrangers.ag.org](http://www.royalrangers.ag.org)

- Please review the Privacy Policy and Legal Notices on the store home page.
- Order Direct feature offers speedy ordering—just insert any item number and quantity into the blank order form.
- Prices and discounts on the web site supersede all previous web site listings, are not guaranteed, and are subject to change without notice.
- Some special pricing may not appear on the web, but may be applied when order is processed.
- Drop ship items cannot be ordered on the web site.

## PRICE STRUCTURE

You will notice in our pricing structure that we offer many items which are quantity priced. These must be ordered in the multiples stated. Examples: 25 for \$2.50, 50 for \$4.50, 100 for \$7.95. Also, we offer items per package and per pad. The descriptive information will state how many pieces per package or pad, but you should order the number of packages or pads you need, not the number of pieces within the package or pad.

## CHECK OR CHARGE?

For your convenience, we accept 6 forms of payment: VISA, MasterCard, Discover, GPH charge, check, and money order. (We cannot be responsible for currency.) To open a GPH charge account, write to Gospel Publishing House, 1445 N. Boonville Avenue, Springfield, MO 65802-1894. Charges on these accounts are due in full within 30 days from the billing date and are subject to a late payment when delinquent. When placing charge orders or making payments always give your GPH account number. Unless you have established credit, a check or money order must accompany your order.

Note: We reserve the right to refuse credit.

## SHIPPING INFORMATION

Merchandise is generally shipped by the most economical method and you are billed postage and handling according to this scale:

Less than \$10.00.....	add 15%
\$10.00-\$49.99.....	add 10%
\$50.00 or more.....	add 8%

Foreign orders will be billed actual shipping.

- Allow 7-10 days for delivery. Orders do not travel on weekends and holidays.
- For faster delivery, please give the specific date you wish to receive your order with a complete street address. Additional fees may apply.
- From the date we receive your order it is usually processed and shipped within 3 working days.
- Items too large for parcel post or UPS, such as some chalkboards and letterboards, will be shipped via commercial truck with freight charges payable upon delivery.
- Drop ship items take 3-4 weeks for delivery.

## RETURN PROCEDURES

You may return merchandise within 30 days of the billing date on your invoice except as noted below. To enable us to process your return as quickly as possible, please follow these instructions:

- Wrap the merchandise securely (not in newspaper). Use the original carton if possible.
- Write a letter indicating your reason for returning the product.
- Enclose your letter and a copy of the invoice with the package.
- For your own protection, insure the merchandise, since refunds will not be made on items that are damaged or lost in the process of being returned.
- Recordings, cassettes, videos, special order items, and items advertised as non-refundable cannot be returned unless they are defective.
- Opened software cannot be returned unless defective.
- A 15% or 20% restocking fee may apply to audiovisual equipment and classroom equipment. See those pages in the General Catalog for further information.

## BUY A LOT ... SAVE A LOT ...

The following quantity discounts are offered on books and music published by Gospel Publishing House (items with item number prefix 02 and 05 only). This offer applies only to items not already listed with quantity discounts.

Quantity discount does not apply to program materials such as Missionettes, Royal Rangers, etc.

10 to 24 copies of one title.....	10%
25-49 copies of one title.....	15%
50 or more copies of one title.....	20%

We also offer a quantity discount on books and music we sell from other publishers. This includes item numbers with the prefix 03 and 04 which are not already listed with a quantity discount.

10 or more copies of one title.....	10%
-------------------------------------	-----

## ABOUT THOSE PRICES ...

The prices and discounts in this catalog supersede all previous listings, are not guaranteed, and are subject to change without notice.

## QUESTIONS? INQUIRIES?

If you have questions about your order, or if you need product information, please write or call GPH. Collect calls cannot be accepted.

GOSPEL PUBLISHING HOUSE  
1445 N. Boonville Avenue  
Springfield, Missouri 65802-1894

1-800-641-4310  
7:00 a.m.-6:30 p.m. Central Standard Time

We regret we cannot intercept in-process orders. Should you wish to change or cancel an order, please follow our RETURN PROCEDURES.

## SALES TAX

State sales tax will be added where applicable. A tax exemption certificate must be provided prior to or at the time of sale for the order to be considered tax exempt.

## NOTE:

All of the books (with item number prefix 03) in this catalog contain valuable material for discerning readers; however, some of them may contain doctrinal statements and practices not completely in harmony with the stated position of the Assemblies of God.

# Royal Rangers Order Form



**GOSPEL PUBLISHING HOUSE**  
 1445 N. Boonville Avenue  
 Springfield, MO 65802-1894

Total Quantity	
Del. Code	AD Code <b>MX</b>
PO #	

**IMPORTANT:** Read our Ordering Instructions before ordering.

GPH Account # \_\_\_\_\_ PO # \_\_\_\_\_

Ship To \_\_\_\_\_

Ship to Arrive By \_\_\_\_\_

Address \_\_\_\_\_

City \_\_\_\_\_ State \_\_\_\_\_ Zip \_\_\_\_\_

Person Placing Order \_\_\_\_\_

Daytime Phone: (\_\_\_\_\_) \_\_\_\_\_

Make checks payable to Gospel Publishing House.  
 Include your account number on all items.

BILL TO: \_\_\_\_\_

Address \_\_\_\_\_

City \_\_\_\_\_ State \_\_\_\_\_ Zip \_\_\_\_\_

Check     Money Order     GPH Charge

Card # \_\_\_\_\_ Exp. Date \_\_\_\_\_

Cardholder's Name \_\_\_\_\_

Cardholder's Address (if different than billing address)

Street \_\_\_\_\_

City \_\_\_\_\_ State \_\_\_\_\_ Zip \_\_\_\_\_

Signature \_\_\_\_\_

QTY	CATALOG NUMBER	NAME OF ITEM	PRICE EA.	TOTAL

TOTAL YOUR COMPLETE ORDER ON REVERSE SIDE ➔





## Adventure Rangers Bolo Tie

Wine cord bolo tie with gold-plated tips and adjustable, enamel-faced Adventure Rangers logo. Can be worn by leaders or boys as part of the Class B uniform.

**08MX7152 \$5.99**



## Maroon Tie

Maroon, 4-in-hand tie. Boys size. Part of the Class A uniform. 56-57"

**08MX1325 \$6.95**



## Royal Rangers Tie Tac

Gold-plated with Royal Rangers emblem in color-filled baked enamel.

**15MX0173 \$3.95**

## Adventure Rangers T-Shirt

Indigo blue T-shirts\*. Part of the Class C uniform. 100% heavyweight preshrunk cotton.

<b>Youth M</b>	<b>08MX7141</b>	<b>\$9.99</b>
<b>Youth L</b>	<b>08MX7142</b>	<b>\$9.99</b>
<b>Adult S</b>	<b>08MX7143</b>	<b>\$10.99</b>
<b>Adult M</b>	<b>08MX7144</b>	<b>\$10.99</b>
<b>Adult L</b>	<b>08MX7145</b>	<b>\$10.99</b>
<b>Adult XL</b>	<b>08MX7146</b>	<b>\$10.99</b>
<b>Adult 2XL</b>	<b>08MX7147</b>	<b>\$11.99</b>
<b>Adult 3XL</b>	<b>08MX7148</b>	<b>\$13.50</b>

\*T-shirt colors may vary.

**FAX TODAY**

**1.800.328.0294**

See pages 29-37 for additional uniforms & accessories and awards & recognition items.

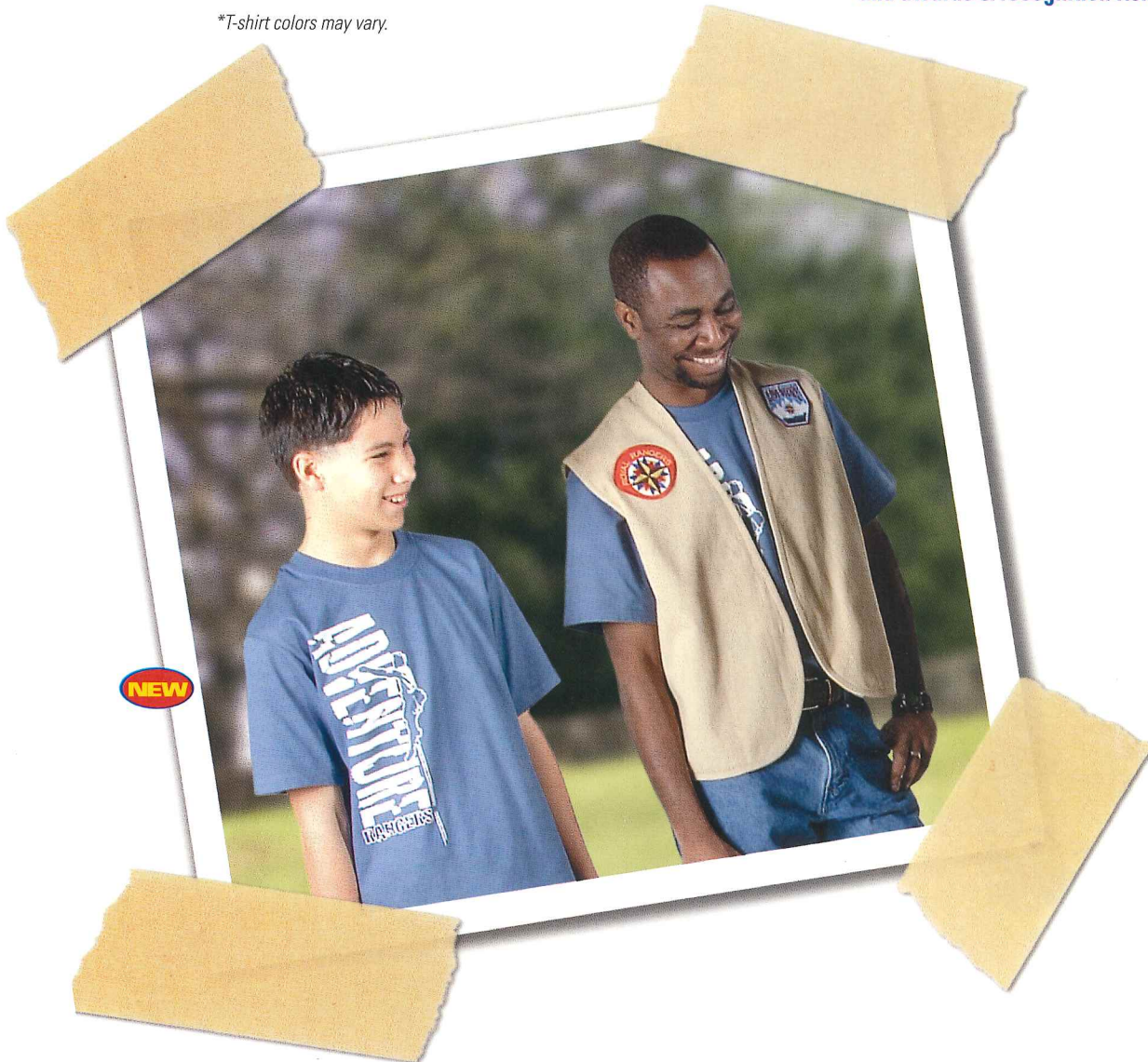



Available Fall 2003



- **Christian service and ministry events**
- **Challenging advancement system**
- **Junior Leadership Camps**

Expedition Rangers will provide you an opportunity to reach youth through a challenging advancement trail program in a variety of areas such as Air, Sea, Trail, God and Country, Chaplain, High Action, and many more.

## **Resources for boys:**

- *Expedition Rangers Handbook* thoroughly explains the program and merit requirements.
- *Expedition Rangers Workbook* provides work pages to help boys meet their merit requirements.

## **Resources for commanders:**

- *Silver Merits Reference* includes answers to the *Workbook* pages and merit reference resources.

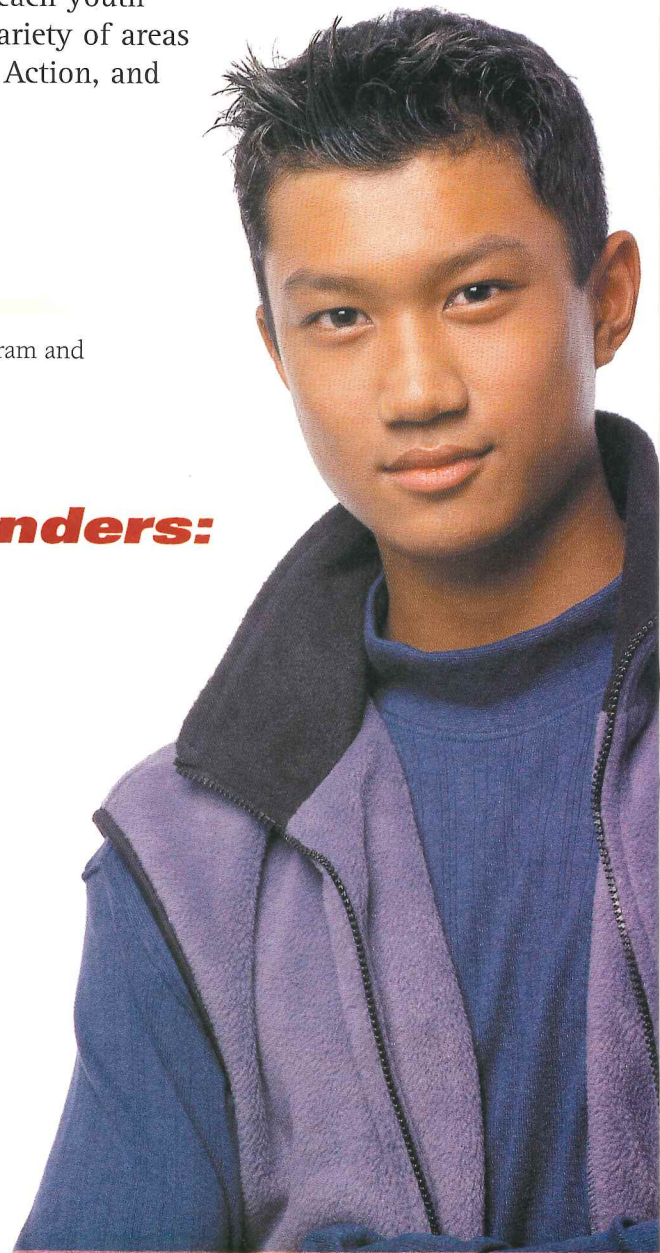

# FRONTIERSMEN CAMPING FELLOWSHIP

## Frontiersmen Camping Fellowship Award Pins

Use to recognize accomplishments within the Frontiersmen Camping Fellowship. Clutch pin clasp.

<b>FCF Frontiersman Pin.</b> 1 <sup>st</sup> level	<b>15MX6943</b>	<b>\$2.50</b>
<b>FCF Buckskin Pin.</b> 2 <sup>nd</sup> level	<b>15MX0277</b>	<b>\$6.50</b>
<b>FCF Wilderness Pin.</b> 3 <sup>rd</sup> level	<b>15MX0278</b>	<b>\$6.50</b>



<b>FCF Company Trapper.</b> 1 <sup>st</sup> level	<b>15MX0517</b>	<b>\$5.50</b>
<b>FCF Bourgeois Trapper.</b> 2 <sup>nd</sup> level	<b>15MX0518</b>	<b>\$5.50</b>
<b>FCF Free Trapper.</b> 3 <sup>rd</sup> level	<b>15MX0519</b>	<b>\$5.50</b>

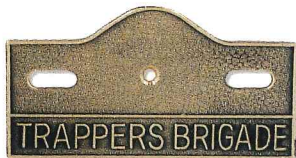

## Pathfinder Award

Worn on khaki uniform after completing Pathfinder mission trip. Clutch pin clasp.

**15MX0152** **\$5.95**

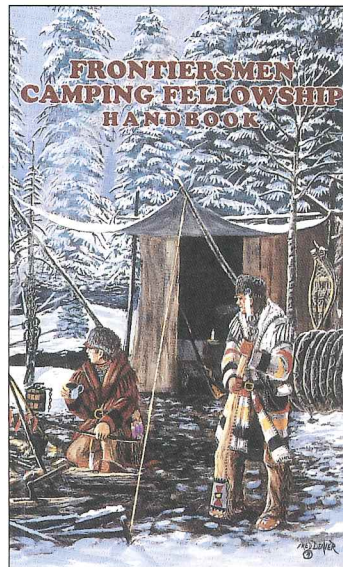

## Frontiersmen Camping Fellowship Handbook

Completely outlines the new Trail of the Grizzly advancement system. Discusses the development and structure of the FCF and provides the frontier traditions and skill requirements for all 3 levels. Required for all boys and leaders involved in FCF. Paper.

**02MX2153** **\$9.99**

## Award Numerals

Used on medal drapes and ribbon bars to distinguish the number of times a particular medal has been earned. Also used with Class B merit ribbon bars.

<b>Numeral 0</b>	<b>15MX0620</b>	<b>Numeral 5</b>	<b>15MX0625</b>
<b>Numeral 1</b>	<b>15MX0621</b>	<b>Numeral 6</b>	<b>15MX0626</b>
<b>Numeral 2</b>	<b>15MX0622</b>	<b>Numeral 7</b>	<b>15MX0627</b>
<b>Numeral 3</b>	<b>15MX0623</b>	<b>Numeral 8</b>	<b>15MX0628</b>
<b>Numeral 4</b>	<b>15MX0624</b>	<b>Numeral 9</b>	<b>15MX0629</b>

**\$1.00 each**



## Grizzly Trail Patch

Earned after completing the 8 merits identified in the *Frontiersmen Camping Fellowship Handbook*, 02MX2153. Merit requirements are found in the Discovery Rangers and Adventure Rangers handbooks and workbooks.

**15MX7554** **79¢**

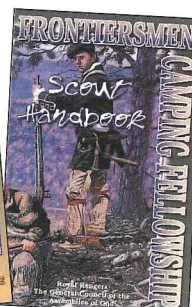

## Frontiersmen Camping Fellowship Brochure

Tells the purpose of FCF, the skills emphasized, what FCF symbols stand for, and how boys and men can join. Paper.

**72MX9018** **10¢**

**FCF Pathfinders Brochure.** Explains the FCF program for Pathfinders. Not Shown. **72MX9019** **10¢**

**FCF Scout Handbook.** **72MX9026** **\$6.00**

**ORDER ONLINE TODAY**

**www.royalrangers.ag.org**



### Royal Rangers Stainless Steel Travel Mug

Stainless steel mug features black Royal Rangers emblem on brushed steel finish. Mug has non-skid bottom and splash-proof, drink-through lid. Handwash only. 16 oz.

17MX7531 \$15.99



### Royal Rangers Sports Bottle

Durable blue plastic beverage bottle with pop-open spout and white Royal Rangers emblem. 20 oz.

17MX0344 \$3.95



### Royal Rangers Thermal Mug

Dark blue mug with white Royal Rangers emblem and no-spill lid. 22 oz.

17MX0294 \$4.25

### Royal Rangers Wallet

Nylon with Velcro™ closing features a gold Royal Rangers emblem and a pencil holder.

Brown  
Navy

17MX0167  
17MX0199  
\$4.95 each



### Buck Knife Protégé

Features a partially serrated 3" blade. Royal Rangers emblem is electro-etched on the blade. Full length is 7 1/2" locked open and 4 1/2" closed. Handle is nonslip thermoplastic rubber. Includes sheath. 3 oz.

17MX0202 \$31.99

### Bucklite Knife

Royal Rangers emblem is electro-etched on the blade. Handle constructed of black nonslip thermoplastic. Length is a compact 4 3/4" closed, with 3" drop point. Impressive 7 3/4" locked open. Weighs 2.5 oz.

17MX0106 \$35.99



### Royal Rangers Lapel Pin

Can be worn on non-uniform apparel to show support of Royal Rangers. Sell to the congregation to raise funds for the Royal Rangers program in your church.

15MX7178 \$2.50  
10-49, \$1.99 ea.  
50 or more, \$1.50 ea.

### Royal Rangers Pen

Maroon pen with gold and black accents features "Royal Rangers" and comfort rubber grip.

16MX7201 \$3.50



### MiniBuck Knife

Royal Rangers emblem is electro-etched on the blade. Handle constructed of black nonslip thermoplastic. Length is 2 7/8" closed, 4 3/4" locked open, with a 1 7/8" drop point. Weighs 1 oz. Can be conveniently attached to key chain.

17MX0107 \$18.99



### Royal Rangers Buck Knife—Folding Hunter

Rounded gold end with Royal Rangers emblem electro-etched on blade. Sharpens easily and stays sharp. Comes with black leather sheath. 4 7/8"

17MX0213 \$54.99



### Royal Rangers Buck Knife—Esquire

Easy to sharpen and stays that way. Slightly rounded silver end. Royal Rangers emblem electro-etched on blade. Comes in black leather sheath. 3 3/4" x 3"

17MX0214 \$49.99

### Royal Rangers Ceramic Mug

Cobalt blue ceramic mug with yellow imprint. Features Royal Rangers emblem and mission statement. 15 oz.

17MX7702 \$7.99



### Royal Rangers Bumper Sticker

White vinyl bumper sticker with a full-color Royal Rangers emblem. Reads: "Building Champions." 3 x 11 1/4"

17MX7800 \$1.25  
10 or more, 85¢ ea.

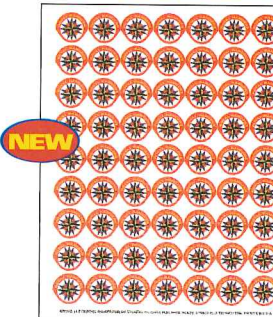

### Royal Rangers Emblem Sticker Sheet

Official Royal Rangers emblem. 63 1" adhesive stickers on 8 1/2 x 11" sheet. 3-hole punched.

14MX7130 \$1.29



### Royal Rangers Decal, Large and Small

Colorful, self-adhesive emblem to use on luggage, notebooks, camping equipment, car doors, and other items.

15 7/8 x 15 1/2" 14MX6802 \$4.99  
3 3/4 x 4 1/8" 14MX6840 60¢

3-11, 50¢ ea.  
12 or more, 35¢ ea.



## DRESS KHAKI UNIFORM

Easy-care dress shirts feature satin-lined collar and yoke, double-needle tailoring, Velcro™ closure pockets, and stitched military creases through pockets and flaps. Long sleeved shirt offers adjustable cuff, two-button closure, and elbow reinforcement. 100% Dacron™ polyester gabardine.

Pants are 100% texturized woven polyester gabardine—a soil-release fabric—with comfort-in-action waistband, quarter top pockets, triple-strength pocketing, tab closure on left rear pocket, double-thick interlined belt loops, French fly extension, self-locking brass zipper, and fashion-set permanent creases.

### Dress Khaki Short Sleeve Shirt\*

Collar 15 1/2"	08MX5881	\$39.50
Collar 16"	08MX5882	\$39.50
Collar 16 1/2"	08MX5883	\$39.50
Collar 17"	08MX5884	\$39.50
Collar 17 1/2"	08MX5885	\$39.50
Collar 18–18 1/2"	08MX5887	\$42.50
Collar 19 1/2"	08MX5888	\$42.50

### Dress Khaki Long Sleeve Shirt\*

Collar 14 1/2" • Sleeve 32–33"	08MX5860	\$42.75
Collar 15" • Sleeve 32–33"	08MX5861	\$42.75
Collar 15 1/2" • Sleeve 32–33"	08MX5862	\$42.75
Collar 15 1/2" • Sleeve 34–35"	08MX5863	\$42.75
Collar 16" • Sleeve 32–33"	08MX5864	\$42.75
Collar 16" • Sleeve 34–35"	08MX5865	\$42.75
Collar 16 1/2" • Sleeve 32–33"	08MX5866	\$42.75
Collar 16 1/2" • Sleeve 34–35"	08MX5867	\$42.75
Collar 16 1/2" • Sleeve 36–37"	08MX5868	\$42.75
Collar 17" • Sleeve 32–33"	08MX5869	\$42.75
Collar 17" • Sleeve 34–35"	08MX5870	\$42.75
Collar 17 1/2" • Sleeve 34–35"	08MX5871	\$42.75
Collar 17 1/2" • Sleeve 36–37"	08MX5872	\$42.75
Collar 18 1/2" • Sleeve 32–33"	08MX5874	\$45.75
Collar 18 1/2" • Sleeve 34–35"	08MX5875	\$45.75
Collar 18 1/2" • Sleeve 36–37"	08MX5876	\$45.75
Collar 19 1/2" • Sleeve 32–33"	08MX5878	\$45.75
Collar 19 1/2" • Sleeve 34–35"	08MX5879	\$45.75
Collar 19 1/2" • Sleeve 36–37"	08MX5880	\$45.75

\*These are professional law enforcement uniforms which include a place for badge attachment that can be removed for Royal Rangers uniform usage.

### Dress Khaki Pants, Unfinished Length

Waist 31"	08MX5889	\$41.25
Waist 32"	08MX5890	\$41.25
Waist 33"	08MX5891	\$41.25
Waist 34"	08MX5892	\$41.25
Waist 35"	08MX5893	\$41.25
Waist 36"	08MX5894	\$41.25
Waist 38"	08MX5895	\$41.25
Waist 40"	08MX5896	\$41.25
Waist 42"	08MX5897	\$41.25
Waist 44"	08MX5898	\$44.25
Waist 46"	08MX5899	\$44.25
Waist 48"	08MX5900	\$44.25
Waist 50"	08MX5901	\$44.25



**CALL TODAY**  
**1.800.641.4310**

## GENERAL KHAKI UNIFORM

The official Royal Rangers uniform is available in a wide range of sizes for men and boys. 65% polyester/35% cotton fabric is permanent press and treated for soil release and easy care. Fine quality, full cut, and tailored to fit. Shirt has the official full-color Royal Rangers emblem embroidered on sleeve—no sewing necessary.

### Men's Khaki Shirt, Short Sleeve

Collar 14½"	08MX0351	\$19.50
Collar 15½"	08MX0352	\$19.50
Collar 16½"	08MX0353	\$19.50
Collar 17½"	08MX0354	\$19.50
Collar 18½". New size	08MX7270	\$21.50
Collar 19½". New size	08MX7271	\$21.50

### Men's Khaki Shirt, Long Sleeve

Collar 14" • Sleeve 32-33"	08MX0330	\$19.95
Collar 14½" • Sleeve 32-33"	08MX0331	\$19.95
Collar 15½" • Sleeve 32-33"	08MX0335	\$19.95
Collar 15½" • Sleeve 34-35"	08MX0336	\$19.95
Collar 16½" • Sleeve 32-33"	08MX0341	\$19.95
Collar 16½" • Sleeve 34-35"	08MX0342	\$19.95
Collar 17½" • Sleeve 32-33"	08MX0346	\$19.95
Collar 17½" • Sleeve 34-35"	08MX0347	\$19.95
Collar 18½" • Sleeve 32-33". New size	08MX7272	\$21.95
Collar 18½" • Sleeve 34-35". New size	08MX7273	\$21.95
Collar 18½" • Sleeve 36-37". New size	08MX7274	\$21.95
Collar 19½" • Sleeve 32-33". New size	08MX7275	\$21.95
Collar 19½" • Sleeve 34-35". New size	08MX7276	\$21.95
Collar 19½" • Sleeve 36-37". New size	08MX7277	\$21.95

### Men's Khaki Pants—Unhemmed

Waist 29"	08MX0540	\$19.95
Waist 30"	08MX0541	\$19.95
Waist 31"	08MX0542	\$19.95
Waist 32"	08MX0543	\$19.95
Waist 33"	08MX0544	\$19.95
Waist 34"	08MX0545	\$19.95
Waist 36"	08MX0546	\$19.95
Waist 38"	08MX0547	\$19.95
Waist 40"	08MX0548	\$19.95
Waist 42"	08MX0549	\$19.95
Waist 44"	08MX0550	\$19.95
Waist 46"	08MX0551	\$19.95
Waist 48". New size	08MX0552	\$21.95
Waist 50". New size	08MX0553	\$21.95



**FAX TODAY**  
**1.800.328.0294**

## Boys' Khaki Shirt, Short Sleeve

- Size 8 • Collar 12½"
- Size 10 • Collar 13"
- Size 12 • Collar 13½"
- Size 14 • Collar 14"
- Size 16 • Collar 14½"

08MX0554	\$17.50
08MX0555	\$17.50
08MX0556	\$17.50
08MX0557	\$17.50
08MX0558	\$17.50

## Boys' Khaki Shirt, Long Sleeve

- Size 8 • Collar 12½" • Sleeve 24½"
- Size 10 • Collar 13" • Sleeve 26"
- Size 12 • Collar 13½" • Sleeve 27½"
- Size 14 • Collar 14" • Sleeve 29½"
- Size 16 • Collar 14½" • Sleeve 31½"

08MX0325	\$17.95
08MX0326	\$17.95
08MX0327	\$17.95
08MX0328	\$17.95
08MX0329	\$17.95

## Boys' Khaki Pants

- Size 8 • Waist 24" • Inseam 21½"
- Size 10 • Waist 25" • Inseam 24"
- Size 12 • Waist 26" • Inseam 26½"
- Size 14 • Waist 27" • Inseam 28½"
- Size 16 • Waist 28" • Inseam 29"

08MX0320	\$18.95
08MX0321	\$18.95
08MX0322	\$18.95
08MX0323	\$18.95
08MX0324	\$18.95

## Boys' Khaki Shorts

Can be worn as part of all groups' Class B and Class C uniforms. Khaki colored cargo shorts with 7 pockets, elastic waist, zippered front, and embroidered Royal Rangers logo. Knee length.

- Size 4 • Waist 21½"
- Size 5 • Waist 22"
- Size 6 • Waist 22½"
- Size 7 • Waist 23"
- Size 8 • Waist 24"
- Size 10 • Waist 25"
- Size 12 • Waist 26"
- Size 14 • Waist 27"
- Size 16 • Waist 28"

08MX7004	\$17.95
08MX7005	\$17.95
08MX7006	\$17.95
08MX7007	\$17.95
08MX7008	\$17.95
08MX7009	\$17.95
08MX7010	\$17.95
08MX7011	\$17.95
08MX7012	\$17.95

## Men's Khaki Shorts

- Waist 29"
- Waist 30"
- Waist 31"
- Waist 32"
- Waist 33"
- Waist 34"
- Waist 36"
- Waist 38"
- Waist 40"
- Waist 42"
- Waist 44"
- Waist 46"
- Waist 48". New size
- Waist 50". New size

08MX7013	\$18.95
08MX7014	\$18.95
08MX7015	\$18.95
08MX7016	\$18.95
08MX7017	\$18.95
08MX7018	\$18.95
08MX7019	\$18.95
08MX7020	\$18.95
08MX7021	\$18.95
08MX7022	\$18.95
08MX7023	\$20.95
08MX7024	\$20.95
08MX7025	\$20.95
08MX7026	\$20.95



## ACCESSORIES

### Tan Denim Vest

Tan stone-washed denim. Part of Class B and C uniforms in Discovery and Adventure Rangers. Can be worn by boys and leaders. 100% cotton.

Youth M	08MX7221	\$8.95
Youth L	08MX7222	\$8.95
Youth XL	08MX7258	\$8.95
Adult XS	08MX7259	\$10.95
Adult S	08MX7223	\$10.95
Adult M	08MX7224	\$10.95
Adult L	08MX7225	\$10.95
Adult XL	08MX7226	\$10.95
Adult 2XL	08MX7227	\$12.95
Adult 3XL	08MX7228	\$13.95
Adult 4XL	08MX7229	\$13.95

### Royal Rangers Cap

Navy brushed cotton twill cap with Royal Rangers emblem embroidered on front. Features adjustable Velcro™ strap. May be worn with Class B and C uniforms.

08MX7268

\$7.99



### Royal Rangers Beret

Tailored of 100% wool. Royal blue with Royal Rangers emblem. May be worn with Class A, B, and C uniforms.

Small • 6 <sup>5</sup> / <sub>8</sub> –6 <sup>3</sup> / <sub>4</sub> "	08MX0271	\$11.50
Medium • 6 <sup>7</sup> / <sub>8</sub> –7"	08MX0272	\$11.50
Large • 7 <sup>1</sup> / <sub>8</sub> –7 <sup>1</sup> / <sub>4</sub> "	08MX0273	\$11.50
XLarge • 7 <sup>3</sup> / <sub>8</sub> –7 <sup>1</sup> / <sub>2</sub> "	08MX0252	\$11.50
2XLarge • 7 <sup>5</sup> / <sub>8</sub> –7 <sup>3</sup> / <sub>4</sub> "	08MX0250	\$11.50



### Royal Rangers Tie Tac

Gold-plated with Royal Rangers emblem in color-filled baked enamel. 5/8"

15MX0173 \$3.95



### Royal Rangers Belt

Khaki color with brass finish buckle. 1<sup>1</sup>/<sub>4</sub> x 1<sup>3</sup>/<sub>4</sub>"

Adjusts to 42"	08MX0214	\$3.75
Adjusts to 48"	08MX0277	\$4.25
Adjusts to 60"	08MX0332	\$4.75

### Royal Rangers Socks

White socks feature embroidered applique of colorful Royal Rangers emblem. Great for wearing with shorts.

Ankle • Size 9–11	08MX7213	\$3.99
Ankle • Size 10–13	08MX7265	\$3.99
Full-Length • Size 9–11	08MX7266	\$4.99
Full-Length • Size 10–13	08MX7267	\$4.99

### Patch Holders

Eliminates the need for sewing or gluing advancement patches and event patches. Vinyl patch holder attaches to the pocket of a shirt to display patch.

2 <sup>1</sup> / <sub>2</sub> " Round. Ranger Kids Advancement Patches	15MX7625	55¢
3 <sup>1</sup> / <sub>8</sub> " Round. Discovery and Adventure Ranger Patches	15MX7626	55¢
3 <sup>1</sup> / <sub>4</sub> " Square. Event Patches. Not shown.	15MX7647	55¢



NEW

## Royal Rangers Emblem Patch

Official emblem embroidered in full-color on white twill background. Apply to awards vests, dress khaki uniforms, and Ranger Kids uniforms.

4 1/4" • Adult

15MX6936 \$3.95

2 1/2" • Youth

15MX6946 \$2.00

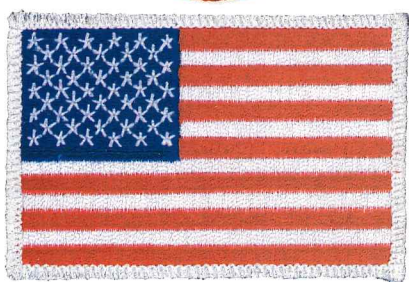

## United States Flag Patch

Required on all Class A and B red and khaki uniforms. Embroidered.

15MX0148 \$1.25

## Class B Ribbon Mounting Bars

Single	15MX0197	75¢
Double	15MX0198	85¢
Triple	15MX0199	95¢

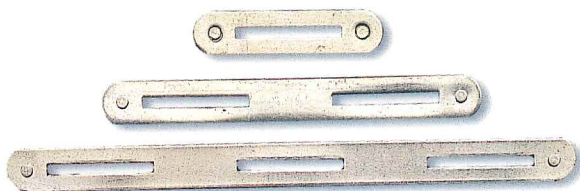

## Outpost Numerals

Numeral 0	15MX0184	Numeral 5	15MX0189
Numeral 1	15MX0185	Numeral 6	15MX0190
Numeral 2	15MX0186	Numeral 7	15MX0191
Numeral 3	15MX0187	Numeral 8	15MX0192
Numeral 4	15MX0188	Numeral 9	15MX0193

65¢ each



## Miniature Outpost Numerals (FOR YOUTH SIZE SHIRTS)

Mini Numeral 0	15MX0594	Mini Numeral 5	15MX0599
Mini Numeral 1	15MX0595	Mini Numeral 6	15MX0600
Mini Numeral 2	15MX0596	Mini Numeral 7	15MX0601
Mini Numeral 3	15MX0597	Mini Numeral 8	15MX0602
Mini Numeral 4	15MX0598	Mini Numeral 9	15MX0603

55¢ each



## District Strips

1 x 3 3/8"

Alabama	15MX0200	No. Cal.-Nevada	15MX0223
Alaska	15MX0245	No. Missouri	15MX0225
Appalachian	15MX0201	No. New England	15MX0224
Arizona	15MX0202	No. Pacific Latin	15MX0846
Arkansas	15MX0203	Northwest	15MX0226
The Bahamas	15MX0195	Ohio	15MX0227
Central Latin	15MX0147	Oklahoma	15MX0228
Georgia	15MX0205	Oregon	15MX0229
German	15MX0262	Pen. Florida	15MX0230
Gulf Latin	15MX0249	Penn.-Del	15MX0194
Hawaii	15MX0246	Potomac	15MX0231
Illinois	15MX0206	Puerto Rico	15MX0161
Indiana	15MX0207	Rocky Mountain	15MX0232
Iowa	15MX0208	S. Carolina	15MX0233
Kansas	15MX0209	S. Dakota	15MX0234
Kentucky	15MX0210	S.E. Spanish	15MX0248
Louisiana	15MX0211	S. Texas	15MX0235
Michigan	15MX0212	So. California	15MX0236
Midwest Latin	15MX0174	So. Idaho	15MX0237
Minnesota	15MX0213	So. Missouri	15MX0238
Mississippi	15MX0214	So. New England	15MX0239
Montana	15MX0215	So. Pacific Latin	15MX0847
Nebraska	15MX0216	Spanish Eastern	15MX0247
New Jersey	15MX0217	Tennessee	15MX0240
New Mexico	15MX0218	West Florida	15MX0241
New York	15MX0219	West Texas	15MX0242
N. Carolina	15MX0220	Wis.-N. Mich	15MX0243
N. Dakota	15MX0221	Wyoming	15MX0244
N. Texas	15MX0222		

75¢ each

## Miniature District Strips (FOR YOUTH SIZE SHIRTS)

3/4 x 2 1/4"

Alabama	15MX0540	No. Cal.-Nevada	15MX0567
Alaska	15MX0541	No. Missouri	15MX0568
Appalachian	15MX0542	No. New England	15MX0569
Arizona	15MX0543	No. Pacific Latin	15MX0848
Arkansas	15MX0544	Northwest	15MX0570
The Bahamas	15MX0611	Ohio	15MX0571
Central Latin	15MX0545	Oklahoma	15MX0572
Georgia	15MX0546	Oregon	15MX0573
German	15MX0610	Pen. Florida	15MX0575
Gulf Latin	15MX0547	Penn.-Del.	15MX0576
Hawaii	15MX0548	Potomac	15MX0577
Illinois	15MX0549	Puerto Rico	15MX0578
Indiana	15MX0550	Rocky Mountain	15MX0579
Iowa	15MX0551	S. Carolina	15MX0580
Kansas	15MX0552	S. Dakota	15MX0581
Kentucky	15MX0553	S.E. Spanish	15MX0593
Louisiana	15MX0554	S. Texas	15MX0582
Michigan	15MX0555	So. California	15MX0583
Midwest Latin	15MX0556	So. Idaho	15MX0584
Minnesota	15MX0557	So. Missouri	15MX0585
Mississippi	15MX0558	So. New England	15MX0586
Montana	15MX0559	So. Pacific Latin	15MX0849
Nebraska	15MX0560	Spanish Eastern	15MX0592
New Jersey	15MX0561	Tennessee	15MX0587
New Mexico	15MX0562	West Florida	15MX0588
New York	15MX0563	West Texas	15MX0589
N. Carolina	15MX0564	Wis.-N. Mich	15MX0590
N. Dakota	15MX0565	Wyoming	15MX0591
N. Texas	15MX0566		

65¢ each

## Restricted National Medals



### Medal of Courage

Special award for any Royal Ranger or leader who has saved a life at no risk of his own.

**Medal.** Class A, B, or denim vest  
15MX0794 \$12.50

**Ribbon.** Class A or B  
15MX0795 \$2.99



### Medal of Valor

Special award for any Royal Ranger or leader who has saved a life at risk of his own.

**Medal.** Class A, B, or denim vest  
15MX0166 \$12.50

**Ribbon.** Class A or B  
15MX0633 \$2.99



*These Awards are restricted and may only be awarded and purchased with the approval of the National Royal Rangers Office. Applicants must meet the requirements outlined by the National Royal Rangers Office and be approved by the National Office. Applications can be obtained from the national Royal Rangers web site.*

## Restricted District Awards



### Gold Buffalo Pin

Gold-finish Medal of Achievement Award pin with clutch clasp. Adventure and Expedition Rangers can continue to earn Gold Buffalo Pins for every 6 additional merits they complete after receiving their Gold Medal of Achievement. 3/8" x 5/8"

15MX0276 \$1.75



### Gold Buffalo Star

Place on Gold Medal of Achievement Ribbon when Royal Rangers earn the Gold Buffalo Pin.

15MX0774 99¢



### Junior Leaders Service Medal

Awarded to Jr. Commanders, Sr. Patrol Guides, and Patrol Guides who have demonstrated outstanding ability in achieving the goals of the Royal Rangers ministry.

**Medal.** Class A, B, or denim vest  
15MX7639 \$11.99

**Ribbon.** Class A or B  
15MX0632 \$1.99



*These Awards are restricted and may only be awarded and purchased by the District Royal Rangers Offices. Applicants must meet the requirements outlined by the National Royal Rangers Office and be approved by their district. Requirements and applications can be obtained from the national Royal Rangers web site.*

## MEDALS & AWARDS



### Missions Project Medal

Can be earned by boys and leaders who have participated in at least a five-day missions trip approved by the MAPS office.

**Medal.** Class A, B, or denim vest  
15MX0151 \$7.50

**Ribbon.** Class A or B  
15MX0734 \$1.99



### Award Numerals

Used on medal drapes and ribbon bars to distinguish the number of times a particular medal has been earned. Also used with Class B merit ribbon bars.

<b>Numeral 0</b>	15MX0620	<b>Numeral 5</b>	15MX0625
<b>Numeral 1</b>	15MX0621	<b>Numeral 6</b>	15MX0626
<b>Numeral 2</b>	15MX0622	<b>Numeral 7</b>	15MX0627
<b>Numeral 3</b>	15MX0623	<b>Numeral 8</b>	15MX0628
<b>Numeral 4</b>	15MX0624	<b>Numeral 9</b>	15MX0629

\$1.00 each



ORDER ONLINE TODAY  
[www.royalrangers.ag.org](http://www.royalrangers.ag.org)

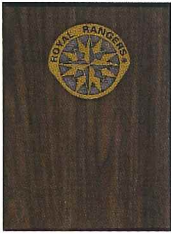

## Royal Rangers Award Plaque

Walnut veneer with Royal Rangers logo die cast in a bronze finish. Comes with detachable 3 x 5" brass plate for engraving. 7 x 9"  
**21MX8210 \$22.95**

**NEW**



## Royal Ranger of the Year Certificate

Recognize every Royal Ranger who meets the standards for Ranger of the Year. Present certificates in *Sheet Protectors, 080227*, so boys can keep them in their workbooks. 11 x 8 1/2"

**Certificates 06MX5303 25 for \$7.75**  
**Sheet Protectors. Box of 100 08MX0227 \$9.95**

**NEW**



## Royal Rangers Junior Leadership Certificate

Recognize Royal Rangers who serve in a leadership capacity. Present certificates in *Sheet Protectors, 080227*, so boys can keep them in their workbooks. 11 x 8 1/2"

**Certificates 06MX5302 25 for \$7.75**  
**Sheet Protectors. Box of 100 08MX0227 100 for \$9.95**

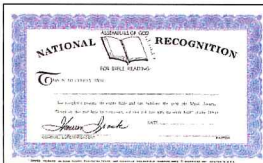

## Bible Reading Certificate

Certificate of recognition for those who complete a full reading of the Bible. 8 x 5 1/4"

**06MX5106 25 for \$3.75**  
**50 for \$5.25**



## Bible Reading Pin

Recognize those who have read the entire Bible with this gold-finish pin and the *Bible Reading Certificate, 06MX5106*. Pin can be worn on the denim awards vest or as a hat pin.

**15MX6977 \$2.50**

## Lock and Beads Award System

Recognizes Royal Rangers in areas of camping, field trips, and hikes; Sunday School and church attendance; Royal Rangers attendance; special service, projects, and events; and other outstanding accomplishments. Each award set contains a leather lock with Royal Rangers emblem and belt slits, 5 leather straps, a bead identification chart, and instructions.

**Lock with Straps 15MX0799 \$2.00**

### Flat Beads

White	15MX0800	Green/Marble	15MX0810
Blue	15MX0801	Blue/Marble	15MX0811
Black	15MX0802	Orange	15MX0812
Green	15MX0803	Brown	15MX0813
Yellow	15MX0804	Red	15MX0816
Yellow/Tan	15MX0805	Red/Marble	15MX0817
Dark Green	15MX0806	Purple	15MX0818
Clear	15MX0808		

### Spherical Beads

Green	15MX0807	White	15MX0814
Purple	15MX0809	Red	15MX0815

20 for \$1.50

Minimum of 20 of any color.



## Firearm Safety Card

Awarded to boys who successfully complete the Firearm Safety Merit. Includes 10 firearm safety rules on back. 2 x 3 1/2"

**07MX5298 25 for \$3.50**



## Tool Craft Safety Card

Awarded to boys who successfully complete the Tool Craft Safety Merit. Includes 3 outdoor tool use rules on back. 2 x 3 1/2"

**07MX5297 25 for \$3.50**

## Mile Award Patches

Awarded to Rangers who complete a 25, 50, or 100 mile bike ride, hike, or canoe trip.

Worn on denim awards vest. Embroidered. 2 3/4 x 4"

<b>25-Mile Award</b>	<b>15MX7618</b>	<b>\$1.75</b>
<b>50-Mile Award</b>	<b>15MX7619</b>	<b>\$1.75</b>
<b>100-Mile Award</b>	<b>15MX7620</b>	<b>\$1.75</b>



## Junior Leadership Patches

Recognize the Royal Rangers who serve in junior leadership positions. Worn on denim awards vest. Embroidered. 2" round

<b>Outpost Chaplain's Assistant</b>	<b>15MX7621</b>	<b>99¢</b>
<b>Outpost Quartermaster</b>	<b>15MX7623</b>	<b>99¢</b>
<b>Outpost Scout</b>	<b>15MX7622</b>	<b>99¢</b>
<b>Outpost Scribe</b>	<b>15MX7624</b>	<b>99¢</b>



# RECOGNITION & AWARDS

## MERIT AWARDS

### Merit Ribbon Bar

Worn on Class A and B uniforms to represent merits earned from a color group. Use with Award Numerals, page 34.

Red	15MX7331	Green	15MX7336
Blue	15MX7332	Brown	15MX7334
Orange	15MX7333	Silver	15MX7337
Gold	15MX7335		

\$1.99 each

### Royal Rangers Merits

Earned by boys and leaders in Discovery Rangers, Adventure Rangers, and Expedition Rangers. Merit requirements are found in boys' handbooks and workbooks. Merit color denoted from its edge. Embroidered. 1 1/2" round

#### Red Merits

Art	15MX7407	Insect Study	15MX7416
BGMC	15MX7191	Jr. LFTL	15MX7417
Bird Study	15MX7436	Lashing	15MX7418
Church	15MX7408	Models & Design	15MX7419
Compass	15MX7410	Rocketry	15MX7446
Cooking	15MX7411	Rope Craft	15MX7422
Family Life	15MX7413	Safety	15MX7423
Fingerprinting	15MX7441	Space Exploration	15MX7425
Fire Craft	15MX7414	Tool Craft	15MX7426
First Aid Skills	15MX7415	Weather	15MX7427

#### Blue Merits

Astronomy	15MX7429	Junior Bible Quiz	15MX7193
Basic Sign Language	15MX7432	Law Enforcement	15MX7445
Basketry	15MX7433	Marksmanship	15MX7440
BB Gun	15MX7434	Music	15MX7447
Chess	15MX7437	Painting	15MX7448
Coin Collecting	15MX7438	Pets	15MX7449
Collections	15MX7409	Pioneer Lore	15MX7420
Darts	15MX7439	Presidents	15MX7421
Disability Awareness	15MX7412	Railroading	15MX7450
Dog Care	15MX7632	Reading	15MX7451
Firearm Safety	15MX7192	Roller Skating	15MX7453
Fishing	15MX7442	Rowing	15MX7454
Hobby	15MX7443	Sculpture	15MX7456
Ice Skating	15MX7444	Senior Citizens	15MX7424
In-Line Skating	15MX7452	Wildlife	15MX7457

#### Orange Merits

Genesis	15MX7359	2 Chronicles	15MX7371
Exodus	15MX7360	Ezra	15MX7372
Numbers	15MX7361	Nehemiah	15MX7373
Deuteronomy	15MX7362	Esther	15MX7374
Joshua	15MX7363	Daniel	15MX7375
Judges	15MX7364	Joel	15MX7376
Ruth	15MX7365	Jonah	15MX7377
1 Samuel	15MX7366	Matthew	15MX7378
2 Samuel	15MX7367	Mark	15MX7379
1 Kings	15MX7368	Luke	15MX7380
2 Kings	15MX7369	John	15MX7381
1 Chronicles	15MX7370	Acts	15MX7382

#### Gold Merits

Advanced Swimming	15MX7524	Environmental Science	15MX7468
Bachelor	15MX7458	First Aid—CPR	15MX7469
Bible	15MX7459	Hiking	15MX7471
Camp Safety	15MX7461	Home Safety	15MX7472
Camping	15MX7460	International Service	15MX7574
Christian Missions	15MX7463	Lifesaving	15MX7473
Christian Service	15MX7462	Light for the Lost	15MX7474
Citizenship	15MX7464	Nature Study	15MX7475
Communications	15MX7466	Physical Fitness	15MX7477
Cycling	15MX7467	Public Speaking	15MX7478
Emergency Preparedness	15MX7541		

79¢ each





# RECOGNITION & AWARDS

## Green Merits

Academics	15MX7598	Forestry	15MX7470
Advanced Disability	15MX7465	Gardening	15MX7499
Awareness	15MX7599	Home Repair	15MX7501
Advanced Marksmanship	15MX7428	Horsemanship	15MX7502
Air Rifle	15MX7480	Indian Lore	15MX7504
Amateur Radio	15MX7481	Knife & Hawk	15MX7505
American History	15MX7482	Leather Craft	15MX7506
Archery	15MX7483	Orienteering	15MX7476
Aviation	15MX7430	Photography	15MX7508
Backpacking	15MX7431	Pioneering	15MX7507
Baseball	15MX7484	Plant Science	15MX7509
Basketball	15MX7484	Pottery	15MX7510
BB Gun	15MX7600	Primitive Shelters	15MX7511
Bible Quiz	15MX7435	Primitive Snares	15MX7518
Bugling	15MX7486	Puppeteer	15MX7512
Canoeing	15MX7487	Reptile Study	15MX7569
Carpentry	15MX7488	Salesmanship	15MX7513
Church History	15MX7489	Skateboarding	15MX7514
Computers	15MX7490	Soccer	15MX7601
Convoy of Hope	15MX7491	Sports	15MX7515
Crime Prevention	15MX7492	Stamp Collecting	15MX7516
Dutch Oven Cooking	15MX7493	Swimming	15MX7479
Energy	15MX7494	Tennis	15MX7517
Family History	15MX7495	Truck Transportation	15MX7519
Fire Safety	15MX7496	Wood Carving	15MX7520
Football	15MX7498	Wrestling	15MX7521

## Brown Merits

Psalms	15MX7383	2 Thessalonians	15MX7395
Proverbs	15MX7384	1 Timothy	15MX7396
Isaiah	15MX7385	2 Timothy	15MX7397
Jeremiah	15MX7386	Titus	15MX7398
Romans	15MX7387	Philemon	15MX7399
1 Corinthians	15MX7388	Hebrews	15MX7400
2 Corinthians	15MX7389	James	15MX7401
Galatians	15MX7390	1 Peter	15MX7402
Ephesians	15MX7391	2 Peter	15MX7403
Philippians	15MX7392	1 John	15MX7404
Colossians	15MX7393	2 & 3 John, Jude	15MX7405
1 Thessalonians	15MX7394	Revelation	15MX7406

## Silver Merits (PARTIAL RELEASE)

Auto Mechanics	15MX7530	Sign Language	15MX7576
Black Powder	15MX7485	Skiing	15MX7577
Chemistry	15MX7533	Track	15MX7584
Foreign Language	15MX7545	Water Safety Instructor	15MX7587
Golf	15MX7548	Wilderness Survival	15MX7590
Hide Tanning	15MX7500	Winter Camping	15MX7591
Home Missions	15MX7556	World Missions	15MX7546
Construction	15MX7556	World Missions	15MX7557
Hunter Education/ Safety	15MX7503	Construction	15MX7525
Sailing	15MX7572	Youth Missions	

79¢ each



CALL TODAY  
**1.800.641.4310**



**Royal Rangers Back Pack**  
 Show yourself ready anytime, anyplace. Sturdy black nylon backpack with bold white Royal Rangers emblem on front. Includes convenient side pockets. Front compartment unzips to an assortment of pouches. 11<sup>3</sup>/<sub>4</sub> x 15<sup>1</sup>/<sub>4</sub> x 6<sup>1</sup>/<sub>4</sub>"  
**17MX7667 \$21.95**

**Sports Bag**  
 Navy cotton canvas with reinforced web straps and self-repairing zipper. Features white imprinted Royal Rangers emblem. 9 x 16"  
**17MX0169 \$12.99**

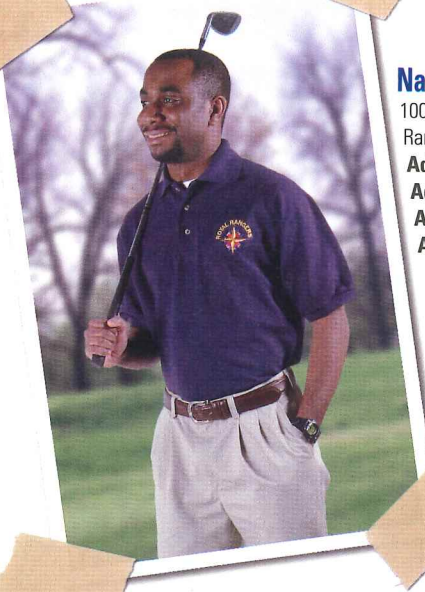

**Navy Deluxe Polo Shirt**  
 100% preshrunk navy cotton pique with Royal Rangers starburst embroidered on left chest.  
**Adult M 08MX6216 \$27.99**  
**Adult L 08MX6217 \$27.99**  
**Adult XL 08MX6218 \$27.99**  
**Adult 2XL 08MX6219 \$29.99**



**Ready Low-Profile Cap**  
 Forest green, brushed cotton, low-profile cap with "Ready," embroidered on front and "Royal Rangers" on back. Adjustable strap.  
**08MX1410 \$12.99**



**Royal Rangers T-Shirt Left Front Emblem**  
 Colorful Royal Rangers emblem on white, 100% heavyweight, preshrunk cotton T-shirt.  
**Youth S • 6-8 08MX0700 \$7.99**  
**Youth M • 10-12 08MX0701 \$7.99**  
**Youth L • 14-16 08MX0703 \$7.99**  
**Adult S 08MX0704 \$8.99**  
**Adult M 08MX0705 \$8.99**  
**Adult L 08MX0706 \$8.99**  
**Adult XL 08MX0707 \$8.99**  
**Adult 2XL 08MX0723 \$9.99**  
**Adult 3XL 08MX1736 \$12.50**  
**Adult 4XL 08MX1737 \$16.50**

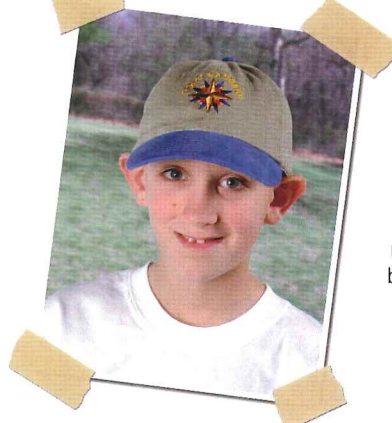

**Royal Rangers 2-Tone Low-Profile Cap**  
 Khaki crown with faded royal blue bill. Royal Rangers starburst is embroidered on front of cap. Brushed cotton with matching fabric strap closure and snapped brass buckle.  
**08MX6240 \$12.99**

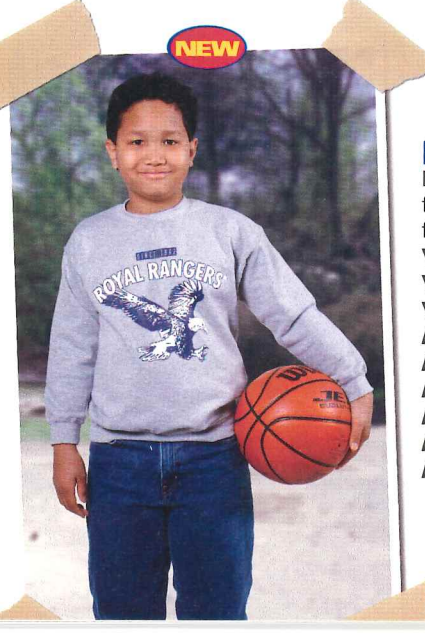

**Royal Rangers Sweatshirt**  
 Durable and comfortable gray sweatshirt features eagle and "Royal Rangers" on front. 50% cotton/50% polyester.  
**Youth S • 6-8 08MX7230 \$14.99**  
**Youth M • 10-12 08MX7231 \$14.99**  
**Youth L • 14-16 08MX7232 \$14.99**  
**Adult S 08MX7233 \$16.99**  
**Adult M 08MX7234 \$16.99**  
**Adult L 08MX7235 \$16.99**  
**Adult XL 08MX7236 \$16.99**  
**Adult 2XL 08MX7237 \$17.99**  
**Adult 3XL 08MX7238 \$20.99**



**Royal Rangers Black Low-Profile Cap**  
 Pro-style, low-crown, brushed cotton cap with matching fabric snap closure and antique brass buckle. Royal Rangers starburst embroidered on front of cap.  
**08MX6220 \$12.99**

## Royal Rangers Starburst T-Shirt

Light gray T-shirt with Royal Rangers starburst and "Royal Rangers" spelled out in red and blue on upper left chest. 100% heavyweight, preshrunk cotton.

<b>Youth M • 10-12</b>	<b>08MX1053</b>	<b>\$6.95</b>
<b>Youth L • 14-16</b>	<b>08MX1054</b>	<b>\$6.95</b>
<b>Adult S</b>	<b>08MX1055</b>	<b>\$7.95</b>
<b>Adult M</b>	<b>08MX1056</b>	<b>\$7.95</b>
<b>Adult L</b>	<b>08MX1057</b>	<b>\$7.95</b>
<b>Adult XL</b>	<b>08MX1058</b>	<b>\$7.95</b>
<b>Adult 2XL</b>	<b>08MX1059</b>	<b>\$8.95</b>
<b>Adult 3XL</b>	<b>08MX1738</b>	<b>\$12.50</b>

## Royal Rangers T-Shirt, Center Front Emblem

White shirts with colorful Royal Rangers emblem. 100% heavyweight, preshrunk cotton.

<b>Youth S • 6-8</b>	<b>08MX0253</b>	<b>\$7.99</b>
<b>Youth M • 10-12</b>	<b>08MX0255</b>	<b>\$7.99</b>
<b>Youth L • 14-16</b>	<b>08MX0256</b>	<b>\$7.99</b>
<b>Adult S</b>	<b>08MX0257</b>	<b>\$8.99</b>
<b>Adult M</b>	<b>08MX0258</b>	<b>\$8.99</b>
<b>Adult L</b>	<b>08MX0259</b>	<b>\$8.99</b>
<b>Adult XL</b>	<b>08MX0260</b>	<b>\$8.99</b>
<b>Adult 2XL</b>	<b>08MX0298</b>	<b>\$9.99</b>
<b>Adult 3XL</b>	<b>08MX1735</b>	<b>\$12.50</b>
<b>Adult 4XL</b>	<b>08MX0316</b>	<b>\$16.50</b>

## Orange Long Sleeve T-Shirt

Orange T-shirt with "Extreme Rangers" down arm and on back. Encourages boys to be "Mentally, Physically, Spiritually Alert." 100% cotton.

<b>Youth S • 6-8</b>	<b>08MX7240</b>	<b>\$12.99</b>
<b>Youth M • 10-12</b>	<b>08MX7241</b>	<b>\$12.99</b>
<b>Youth L • 14-16</b>	<b>08MX7242</b>	<b>\$12.99</b>
<b>Adult S</b>	<b>08MX7243</b>	<b>\$14.99</b>
<b>Adult M</b>	<b>08MX7244</b>	<b>\$14.99</b>
<b>Adult L</b>	<b>08MX7245</b>	<b>\$14.99</b>
<b>Adult XL</b>	<b>08MX7246</b>	<b>\$14.99</b>
<b>Adult 2XL</b>	<b>08MX7247</b>	<b>\$15.99</b>
<b>Adult 3XL</b>	<b>08MX7248</b>	<b>\$16.99</b>

## Ready for Anything T-Shirt

Black 100% heavyweight, preshrunk cotton T-shirt has "Ready." on front and "Ready for Anything. Period!" imprinted on back.

<b>Youth S • 6-8</b>	<b>08MX1411</b>	<b>\$9.99</b>
<b>Youth M • 10-12</b>	<b>08MX1412</b>	<b>\$9.99</b>
<b>Youth L • 14-16</b>	<b>08MX1413</b>	<b>\$9.99</b>
<b>Adult S</b>	<b>08MX1414</b>	<b>\$10.99</b>
<b>Adult M</b>	<b>08MX1415</b>	<b>\$10.99</b>
<b>Adult L</b>	<b>08MX1416</b>	<b>\$10.99</b>
<b>Adult XL</b>	<b>08MX1417</b>	<b>\$10.99</b>
<b>Adult 2XL</b>	<b>08MX1418</b>	<b>\$11.99</b>
<b>Adult 3XL</b>	<b>08MX1419</b>	<b>\$13.50</b>
<b>Adult 4XL</b>	<b>08MX1420</b>	<b>\$17.50</b>



**NEW**

**FAX TODAY**  
**1.800.328.0294**

## RESOURCES

### Racemaster Electric-Eye Finish-Line Detector

Instantly know the winner of every race with the Finish-Line Detector. Using high-speed sensors, this easy-to-read digital display accurately pinpoints the winner and flashes the winning lane, providing unquestionable race results.

Other features include:

- Easy installation and operation,
- Viewable display from 40 feet,
- Accuracy to within 1/5000 of a second,
- 100% lifetime warranty.

2, 3, or 4 lane

08MX5757

\$385.00\*

5 or 6 lane

08MX5758

\$450.00\*

\*Price includes standard shipping. Allow 4–6 weeks for delivery. When ordering, please specify number of lanes.

*For returns other than a defective product, a 10% restocking fee will be applied.*

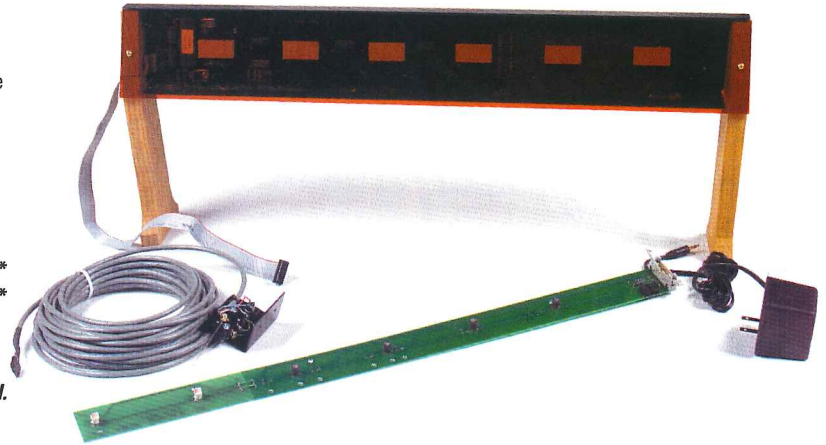

### Racer Display Stand

Sleek metal stand mounted on oak base holds one racer in a trophy-like position. Car not included.

17MX5960

\$4.98

### Checkered Flags

Build race-day excitement and decorate your race areas with this string of black and white checkered flags. Each flag 9 1/8 x 1 1/2". 30' string.

17MX7398

\$6.50



### The Pinewood Derby Video

Upbeat video identifies Pinewood Derby as one of the most popular Royal Rangers events. Take a look at real film footage from a derby, with tips for leaders. Approximately 5 minutes.

72MX9099

\$16.95

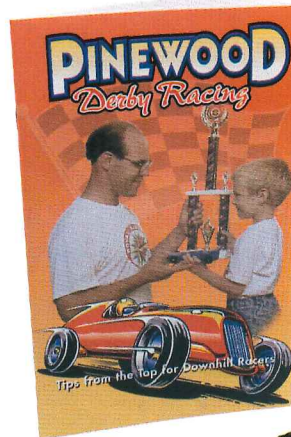
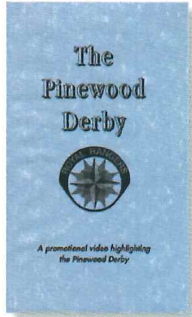

### Pinewood Derby Racing: Tips from the Top for Downhill Racers

Win derby races with a car built like pinewood pros. Features include: How to build a car, how to make your racer faster, how to build a track, setting up the race, and sample forms. Paper.

02MX5060

\$2.99

10 or more, \$1.99 ea.

## APPAREL

### Pinewood Derby T-Shirt

Outfit your racers in style with this T-shirt featuring a derby car and "Pinewood Derby—Feel the Excitement!" 100% heavyweight, preshrunk cotton.

Youth S • 6–8

08MX6400

\$7.99

Youth M • 10–12

08MX6401

\$7.99

Youth L • 14–16

08MX6402

\$7.99

Adult S

08MX6403

\$8.99

Adult M

08MX6404

\$8.99

Adult L

08MX6405

\$8.99

Adult XL

08MX6406

\$8.99

Adult 2XL

08MX6407

\$9.99

Adult 3XL

08MX6408

\$12.50

Adult 4XL

08MX6409

\$16.50



## CAR KITS & ACCESSORIES

### Pinewood Car Kit

Contains all necessary parts for a basic car:  
Pine body, black plastic wheels, axles, and screws.

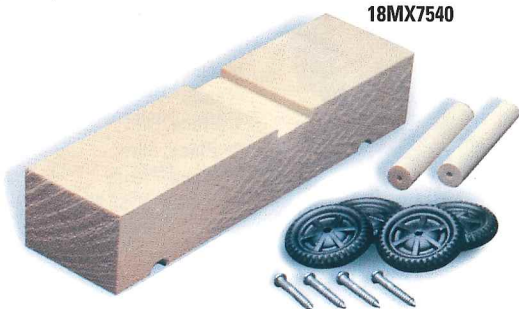

**18MX7540** **\$2.50**



### Windshield Kit

Customize your car with one of several design options. Kit includes: Driver, roll bar, seatback, and vinyl patterns. Attaches with glue.

**17MX5955** **\$2.98**

### Custom Parts

Easily transform a simple car project into an exciting work of pride!

**A. Formulator.** Exhaust pipes, driver's head, windshield, roll bar, and engine.

**17MX0125** **\$2.98**

**B. Dune Buster.** Roll bar, exhaust pipes, and lights.

**17MX0122** **\$2.98**

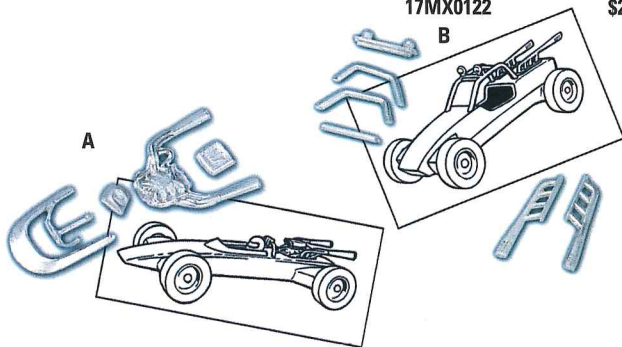

### Canopy Set

Transforms a plain pinewood car into a red-hot racing machine. Package contains 3 styles to choose from, including colorful stick-on decals.

**17MX0118** **\$2.98**



### Personalized Plates Stickers

Provides at least 4 of every letter and number to create up to 4 personalized adhesive sticker license plates.

**14MX6829** **\$1.75**

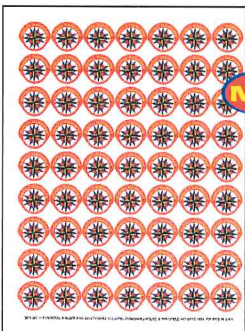

### Royal Rangers Emblem Sticker Sheet

Official Royal Rangers Emblem. 63 1" adhesive stickers on 8 1/2 x 11" sheet. 3-hole punched.

**14MX7130** **\$1.29**



### Headlights

Come in pairs ready to paint and glue on to car.

**17MX7400** **20¢**



### Steering Wheel

Wooden steering wheel attaches to car with screw (included) and turns.

**17MX7399** **20¢**

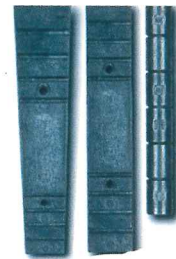

### Weights

**Lead Weight.** 3.5 oz.

**18MX7543** **\$1.95**

**Strip Weight\***. Approx. 2 oz.

**17MX5958** **\$3.29**

**Combo Weight\***. Approx. 2 oz.

**17MX5959** **\$3.29**

\* 99.9% lead free



### Formula Glue

Hi-tack, fast-setting white glue adheres to metal, plastic, and wood. Dries clear. Nontoxic and nonflammable. 5 oz.

**18MX7535** **\$2.79**

### Graphite Lube

Micro-fine graphite keeps wheels running smoothly race after race. 21 oz.

**18MX7542** **\$1.75**



### Acrylic Paint Kit

Provides 6 mini-pots of paint: Red, blue, green, yellow, white, and black. Brush included.

**18MX7541** **\$1.75**

CALL TODAY  
**1.800.641.4310**

## RECOGNITION & AWARDS

### Pinewood Derby Trophies

Eye-catching wood and plastic trophies display a Pinewood Derby car and place of finish.

<b>1<sup>st</sup> Place.</b> 7"	<b>17MX7390</b>	<b>\$7.75</b>
<b>2<sup>nd</sup> Place.</b> 5 1/2"	<b>17MX7391</b>	<b>\$5.75</b>
<b>3<sup>rd</sup> Place.</b> 4"	<b>17MX7392</b>	<b>\$4.75</b>



### Pinewood Derby Medals

Each gold, silver, or bronze medal comes with a red, white, and blue ribbon. Medals are engraved with "Pinewood Derby" and car. Can be worn on non-uniform apparel to show support of Royal Rangers. Safety pin back.

<b>1<sup>st</sup> Place.</b> Gold	<b>17MX7436</b>
<b>2<sup>nd</sup> Place.</b> Silver	<b>17MX7437</b>
<b>3<sup>rd</sup> Place.</b> Bronze	<b>17MX7439</b>
	<b>\$2.95 each</b>



### Pinewood Derby Ribbons

Combined with trophies or given individually, these ribbons assure that every Royal Ranger receives an award for effort.

<b>1<sup>st</sup> Place.</b> Blue	<b>17MX7393</b>	<b>55¢</b>
<b>2<sup>nd</sup> Place.</b> Red	<b>17MX7394</b>	<b>55¢</b>
<b>3<sup>rd</sup> Place.</b> White	<b>17MX7396</b>	<b>55¢</b>
<b>Participant.</b> Light Blue	<b>17MX7397</b>	<b>55¢</b>



### Pinewood Derby Racing Flag Pins

A checkered flag, Royal Rangers flag, and number are featured on these brightly-colored enamel and gold-tone pins. Great for use as yearly participant awards or as prizes for race placement. Can also be worn on non-uniform apparel to show support of Royal Rangers. 1 1/4 x 7/8"

<b>1<sup>st</sup></b>	<b>15MX7140</b>	<b>\$2.25</b>
<b>2<sup>nd</sup></b>	<b>15MX7141</b>	<b>\$2.25</b>
<b>3<sup>rd</sup></b>	<b>15MX7142</b>	<b>\$2.25</b>
<b>4<sup>th</sup></b>	<b>15MX7143</b>	<b>\$2.25</b>



### Lapel Pin

Full-color enameled pin has Pinewood racer, checkered flag, and gold highlights. Can be worn on non-uniform apparel to show support of Royal Rangers. Clutch pin back. 7/8 x 1 1/8"

<b>15MX0117</b>	<b>\$1.99</b>
-----------------	---------------

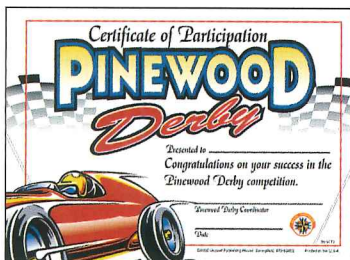

### Royal Rangers Pinewood Derby Placement Certificate

Colorful award certificate providing spaces for winner's name and competition category, class, and division. Also provides signature space for Derby Coordinator. 7 1/2 x 5 1/2"

<b>06MX5108</b>	<b>25 for \$5.50</b>
-----------------	----------------------



### Royal Rangers Pinewood Derby Participant Certificate

Colorful certificate congratulating those who participated in the derby. Provides spaces for participant's name and class of competition. 7 1/2 x 5 1/2"

<b>06MX5112</b>	<b>25 for \$5.50</b>
-----------------	----------------------

ORDER ONLINE TODAY  
[www.royalrangers.ag.org](http://www.royalrangers.ag.org)

## RACING DECALS

### Templates and Stick-On Decals

Transforms a block of wood into a sleek racer. Includes templates and full-body, stick-on decals.

**Track Twister.** 3 1/2 x 7 1/2" sheet

17MX0130

\$3.98

**Hot Wings.** 3 1/2 x 7 1/2" sheet

17MX0141

\$3.98



### Dry Transfer Decals

Rub-on decals apply in seconds. Perfect for contours and textured surfaces.

**Sponsors and Numbers.** 4 x 5" sheet

14MX6900

\$4.69

**Nascar.** 4 x 5" sheet

14MX6901

\$4.69

**Custom Designs.** 4 x 5" sheet

14MX6902

\$4.69

**Stripes and Flames.** 4 x 5" sheet

14MX6904

\$4.69

**Off Road.** 4 x 5" sheet

14MX6910

\$4.69

**Dragon Fire.** 4 x 2" sheet

14MX6905

\$3.29

**Magnum.** 4 x 2" sheet

14MX6906

\$3.29

**Stinger.** 4 x 2" sheet

14MX6907

\$3.29

**Spyder.** 4 x 2" sheet

14MX6908

\$3.29

**Turbo.** 4 x 2" sheet

14MX6909

\$3.29

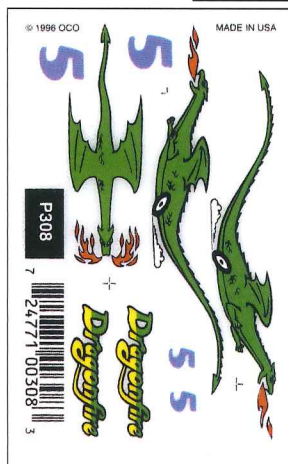

## Wet Process Decals

Get a professional detail look with these easy-to-use decals. Dip in water, hold in place, and remove backing paper. Requires a glossy surface.

<b>Flames</b>	<b>14MX6826</b>	<b>\$2.65</b>
<b>Number Sheet #24</b>	<b>14MX6830</b>	<b>\$2.65</b>

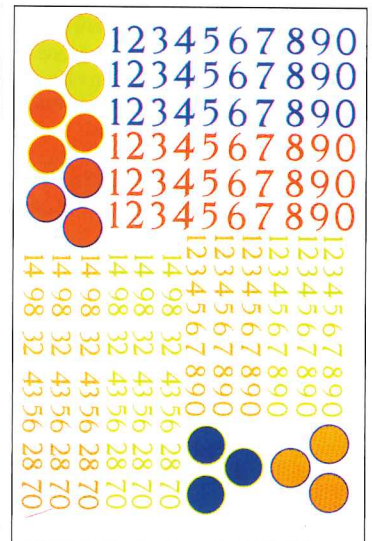

## Stick-on Decals

Featuring new designs—vivid colors, high quality, easy-to-use. All a racer has to do is cut them out, peel them off, and stick them on.

<b>Silver Shark</b> . 4 x 2 1/2" sheet	<b>14MX7080</b>	<b>\$2.69</b>
<b>Road Rocket</b> . 4 x 5" sheet	<b>14MX7081</b>	<b>\$3.69</b>
<b>Horse Power</b> . 4 x 5" sheet	<b>14MX7082</b>	<b>\$3.69</b>
<b>NEW Stars and Stripes</b>	<b>14MX6858</b>	<b>\$3.49</b>

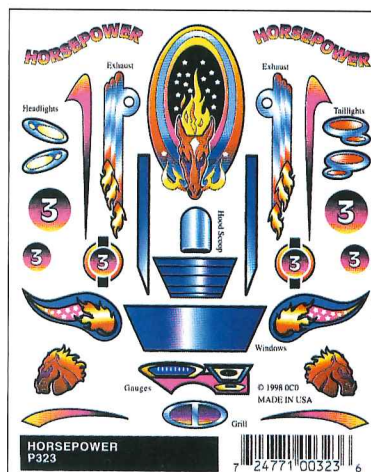
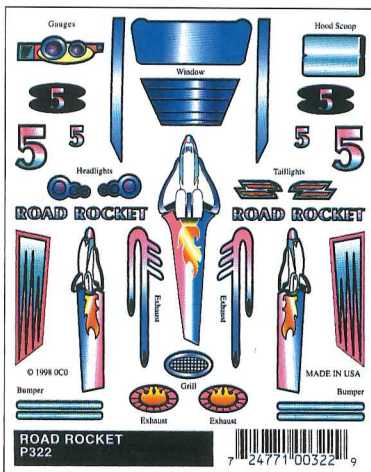

## Christian Symbol Stickers

Adhesive stickers show your Christian witness all the way to the finish line. Sticker sheet contains 15 designs with Christian symbols and themes.

<b>14MX6869</b>	<b>\$3.55</b>
-----------------	---------------

**FAX TODAY**  
**1.800.328.0294**





## CAMPING KNOWLEDGE & PREPARATION

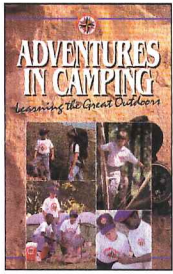

### Adventures in Camping

This manual is important reading for every Royal Ranger. Teaches boys and commanders what they need to know to have a safe and comfortable outing. Also provides pictures and instructions for many camping related activities such as knots, fire building, and campcraft projects. Paper.

02MX1036 \$7.95

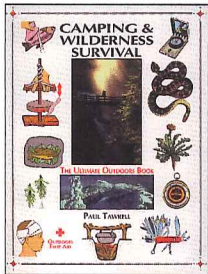

### Camping and Wilderness Survival

by Paul Tawrell

Written to help Rangers acquire skills to enjoy the wilderness. Tells how to travel, make a camp, understand the environment, and choose equipment. In case of an emergency, it explains how to find water, food, shelter, and how to care for yourself if you are sick or injured. Easy-to-read with numerous instructive diagrams and illustrations. Paper. 350 pages. 8 1/2 x 11"

03MX5278 \$24.95

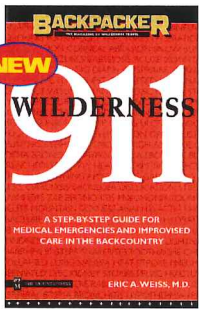

### Wilderness 911

by Eric Weiss

Be prepared for medical problems and emergencies by reading and carrying **Wilderness 911**. Step-by-step guidance keeps things simple, allowing you to quickly diagnose signs and symptoms, treat a wide variety of minor to severe problems, and recognize the need for immediate evacuation. Also explains what to do when first-aid supplies are scarce or non-existent and how to prevent emergencies. Paper.

03MX7166 \$16.95

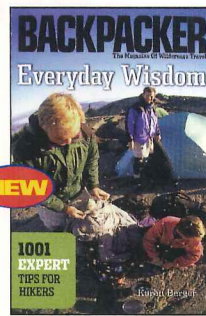

### Everyday Wisdom

by Karen Berger

Learn from seasoned experts how to make do in the backcountry. A one-stop collection of practical advice, time-saving tips, problem-solving techniques, and brilliant improvisations that teaches hikers how to prepare for the predictable and solve problems by avoiding them. Paper.

03MX7301 \$16.95

### The Handbook of Knots

by Des Pawson

Clear instructions and step-by-step photographs teach readers how to tie more than 100 knots. Quick-reference symbols show which knots to choose for camping, fishing, sailing, climbing, and general or decorative use. Also discusses selecting the correct type of rope. Paper.

03MX7560 \$16.95

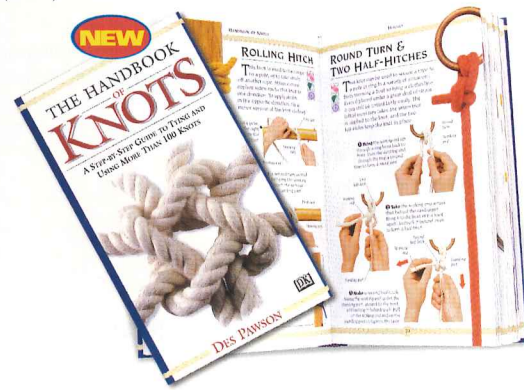

## ESSENTIALS & PERSONAL GEAR



### Royal Rangers Back Pack

Show yourself ready anytime, anyplace. Sturdy black nylon backpack with bold white Royal Rangers emblem on front. Includes convenient side pockets. Front compartment unzips to an assortment of pouches. 11 3/4 x 15 1/4 x 6 1/4"

17MX7667 \$21.95



### Sports Bag

Navy cotton canvas with reinforced web straps and self-repairing zipper. Features white imprinted Royal Rangers emblem. 9 x 16"

17MX0169 \$12.99



### Survival Candle

Lightweight and compact candle burns 12 to 36 hours depending on the number of wicks lighted.

08MX5727 \$3.99



### Trail Box First Aid Kit

Assortment of 43 essential first aid items stored in a lightweight, unbreakable plastic box. Moleskin and first aid guide included. 3 1/2 x 4" size fits in back pack or tackle box.

08MX6014 \$4.99



### 5-in-1 Survival Whistle

All-in-one survival whistle comes with shrill signal whistle, compass with luminous dial, waterproof match container, signal mirror, and flint fire starter. Lightweight plastic case with lanyard. Color may vary. 1 x 4 3/8"

08MX6011 \$4.50

### Emergency Survival Kit

Essential items packed in heavy-gauge vinyl waterproof utility pouch with carrying cord and self-sealing Velcro™ closure. Contains poncho, signal mirror, waterproof match box, waterproof matches, flashlight, whistle, compass, wire saw, emergency blanket, fish hooks, leader line and sinkers, sewing needle, and razor. 6 x 9"

08MX6013 \$14.99



## SHELTER, COOKING GEAR, & MISCELLANEOUS EQUIPMENT



### Polarshield Emergency Blanket

Compact emergency protection in all weather conditions. Retains 90% of body heat. Waterproof and windproof, will not crack, mildew, or shrink. 12 oz. 82 x 50"

08MX5721 \$1.99

### The Tube Tent

Light and compact waterproof tent sets up in minutes. Sleeps 2 comfortably. Constructed of heavyweight vinyl. Can be used as an emergency shelter or ground cloth.

08MX5726 \$4.99



### Collapsible Cup

Sturdy plastic, telescoping drinking cup. Collapses easily for portability. Includes 2 cups. 4 oz.

08MX6009 \$1.99



### Knife, Fork, and Spoon Set

Durable, rust-proof stainless steel set attaches together in one compact unit. Comes in a vinyl carrying case.

08MX5722 \$1.99



### Deluxe Camp Saw

Durable steel frame with 15" detachable cross-cut blade bolted with lock nuts at 4 stress points. Self-locking handle.

08MX6015 \$6.49



### 3-in-1 Can Opener

Durable tempered-steel can opener, bottle opener, and spoon combination. 2 per pkg.

08MX5723 \$1.49



### One-Quart Plastic Canteen and Cover Set

High impact plastic canteen with screw-on cap and security strap. Insulated, fully lined cotton cover designed to fit on pistol belt.

08MX0782 \$4.99

### Double Folding Survival Shovel

Durable tempered steel blade and metal handle. Compactly folds up in 3 sections from a total length of 23 1/2" to 9" for easy storage. G.I. style. Blade size is 6 x 8 1/4".

08MX6017 \$9.99

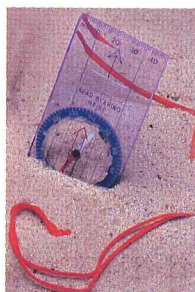

### Map Compass

Features easy-to-grip rotating compass ring and 2 degree increments for accurate readings. Liquid filled. Measures length and distance. Includes built-in magnifier for easy map reading. 2 1/2 x 4"

08MX6016 \$7.99

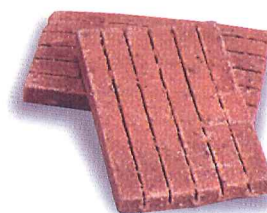

### Fire Starter Stick

Starts fires quickly and safely. Leaves no odor and burns completely. Waterproof. Easy to pack and store. Non-toxic. Contains 12 sticks.

08MX6010 \$2.49

## Design and Text Pencils

Brightly colored round lead pencils. No. 2 black lead.

**Happy Birthday.** White imprint on assorted colors.

**Books of the New Testament.** Assorted neon colors with black imprint.

**Sign Language Pencil.** Blue imprint displays the sign alphabet.

6 for \$1.80

16WA7110

16WA7062

16WA7163



## Styrofoam Plane

White lightweight flyer says, "Fly high with Jesus." 9" wing span.

17WA7313

79¢

## Neon Rulers

Neon rulers in assorted colors. 12"

**Rule for Life.** Plastic

**Fruit of the Spirit.** Plastic

**Old & New Testaments.** Wooden

**Old & New Testaments—Spanish.** Wooden

17MX7684

\$1.10

17MX7685

\$1.10

17MX7686

\$1.10

17MX7687

\$1.10

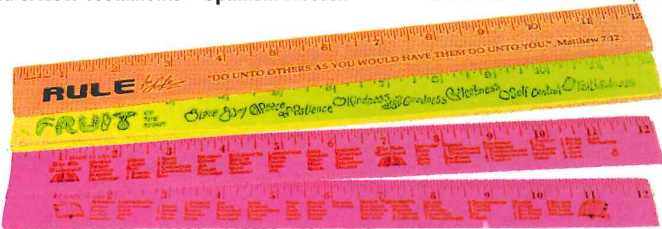

## New Kid in the Spirit Tract

Cartoon tract explains who the Holy Spirit is, what He does in a Christian's life, and that He works in children as well as adults. Includes corresponding Scripture verses and how to be filled with the Holy Spirit. 5½ x 4¼"

03MX6289

10 for \$7.99

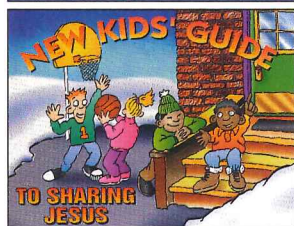

## New Kids' Guide to Sharing Jesus Tract

Cartoon tract explains witnessing and why children should actively participate. Includes corresponding Scripture verses and 4 steps to get you started. 5½ x 4¼"

03MX6290

10 for \$7.99



## New Kid in the Kingdom Tract

Cartoon tract explains the plan of salvation and kids' need for it. Includes corresponding Scripture verses, prayer for salvation, and what to do next. 5½ x 4¼"

03MX6292

10 for \$7.99

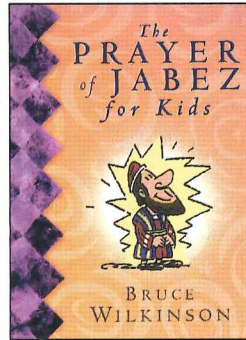

## The Prayer of Jabez for Kids

by Bruce H. Wilkinson

Brings the same size, format, and most importantly, the same message of *The Prayer of Jabez*. Adds terrific features that will appeal to kids such as line art cartoons, friendly designs and snapshots of key biblical characters who lived big for God. For ages 8–12. Hard.

03MX7270

\$9.99

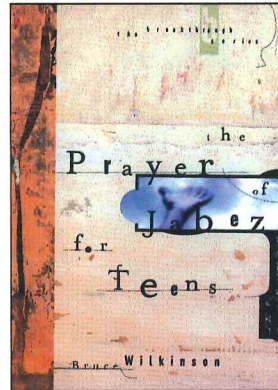

## The Prayer of Jabez for Teens

by Bruce H. Wilkinson

Now teens can receive extravagant blessing as they discover in peer-based stories, supporting Scripture, and interactive questions how to pray the remarkable prayer of Jabez. Includes study guide questions for personal or group use. Hard.

03MX6555

\$9.99

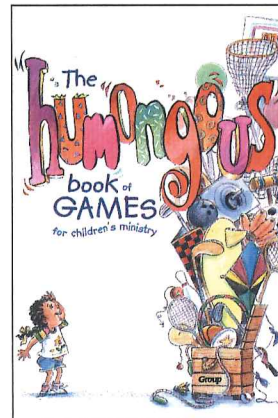

## The Humongous Book of Games for Children's Ministry

Features hundreds of games that connect with various topics and hundreds of Scriptures. Divided into 3 age groups: Preschool, lower elementary, and upper elementary. Includes energy-level index and Scripture index. Paper.

03MX5798

\$21.99

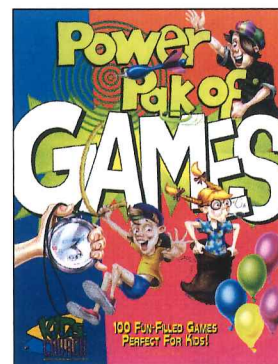

## Power Pak of Games

Fuel up children's programs with more than 100 fun games divided into 8 categories: Water games, action, food and drink, hide and seek, relay, strength and skill, toss and throw, and guessing. Prop lists and complete instructions. Paper.

03MX3541

\$12.99

CALL TODAY  
**1.800.641.4310**

## 2:52 SOUL GEAR

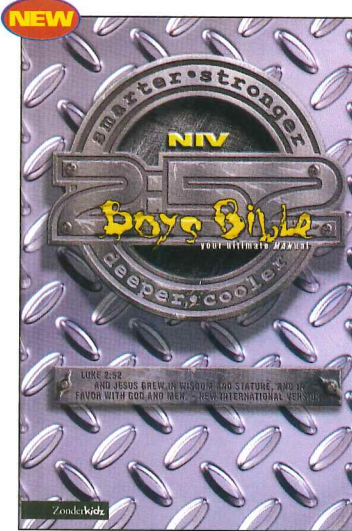

### The Boys Bible

The "ultimate manual" for boys ages 8 to 12. Based on Luke 2:52, "And Jesus grew in wisdom and stature, and in favor with God and man," **The Boys Bible** challenges boys to become more like Jesus mentally, physically, spiritually, and socially—smarter, stronger, deeper, and cooler. Contains the full-text of the NIV® plus additional features: *Make It Stick*, entry spaces for fun doodles and quick responses to the text; *Gross*, gross facts in the Bible; and *Get a Load of This*, interesting facts about Bible times and characters.

**Hard** 01MX0108 \$26.99  
**Paper** 01MX0109 \$21.99

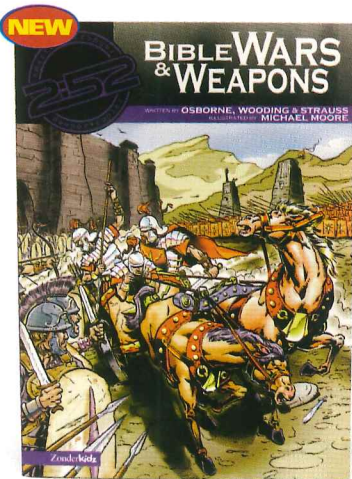

### Bible Wars and Weapons

by Rick Osborne, Marnie Wooding, and Ed Strauss

Filled with maps and illustrations of army units, **Bible Wars and Weapons** takes readers to the frontlines of Bible-time battles. It describes the people who fought the wars and the equipment and armor they used. Shows boys ages 8 to 12 what the battles of the Bible can teach them in the pursuit to be smarter, stronger, deeper, and cooler. Paper.

03MX5198 \$7.99

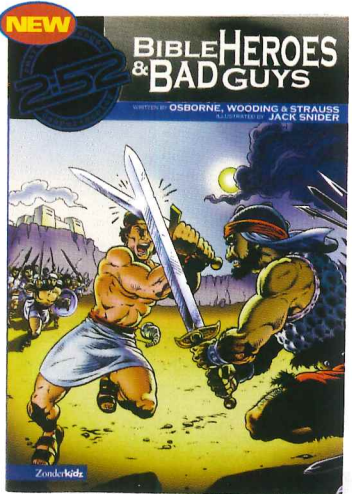

### Bible Heroes and Bad Guys

by Rick Osborne, Marnie Wooding, and Ed Strauss

There's more to being a hero than just having muscles. **Bible Heroes and Bad Guys** teaches kids about Bible men and women who were heroic in their courage, mercy, trust, honesty, and wisdom. Paper.

03MX5197 \$7.99



### Bible Fortresses, Temples and Tombs

by Rick Osborne, Marnie Wooding, and Ed Strauss

Takes boys on an expedition to uncover hidden mysteries of biblical cities. Starting at the Tower of Babel and ending in the New Jerusalem, readers will visit pyramids, death pits, and dung heaps in their quest to learn more about the Bible. Paper.

03MX5199 \$7.99

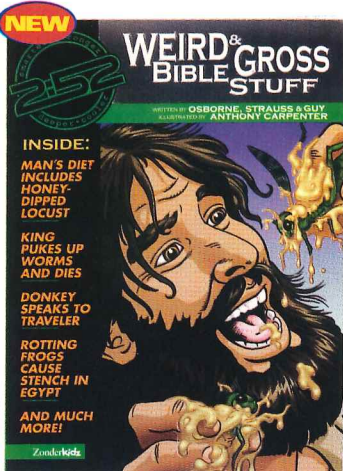

### Weird and Gross Bible Stuff

by Rick Osborne, Ed Strauss, and Quentin Guy

Boys who have an appetite for the weird and grotesque will be captivated by accounts of *Bizarre Healings*, *Weird Wonders*, *Outrageous Lies and Excuses*, *Beasts and Beings*, and *Bloopers and Blunders*. These stories and more will teach boys biblical truths and encourage them to become more like Jesus. Paper.

03MX7167 \$7.99

ORDER ONLINE TODAY

[www.royalrangers.ag.org](http://www.royalrangers.ag.org)

"Your handbell music is great! The first time my Ranger Kids performed, the audience loved it. A standing ovation! I wasn't sure the applause would ever stop."

Jean Lawson  
Ranger Kids Leader  
Praise Assembly



## Handbell Music and Bells

Enjoy an instant handbell choir without hours of practice. Each set of music includes chord cards and a CD with practice and professional accompaniment tracks. 8 brightly colored, metal bells have solid plastic handles and a durable plastic clapper.

	<b>Handbell Music Set 1.</b> <i>All Hail the Power of Jesus' Name, Battle Hymn of the Republic, Christ the Lord is Risen Today, Joy to the World, and O Holy Night.</i>	<b>28MX0168</b>	<b>\$44.95</b>
<b>New Music</b>	<b>Handbell Music Set 2.</b> <i>Amazing Grace; Oh, How I Love Jesus; Standing on the Promises; Victory in Jesus; and What a Friend We Have in Jesus.</i>	<b>28MX0208</b>	<b>\$44.95</b>
<b>New Music</b>	<b>Handbell Music Set 3.</b> <i>Available Summer 2003. Deep and Wide; Down in My Heart; God Is So Good; Hallelu, Hallelu; He's Got the Whole World; His Banner Over Me; Jesus Loves Me; The B-I-B-L-E; This Little Light of Mine; and What a Mighty God.</i>	<b>28MX0209</b>	<b>\$44.95</b>
	<b>Handbells</b>	<b>08MX0282</b>	<b>\$44.95</b>
<b>Best Value</b>	<b>Handbell Starter Kit 1.</b> Includes Music Set 1 and handbells.	<b>08MX0284</b>	<b>\$79.95</b>
<b>Best Value</b>	<b>Handbell Starter Kit 2.</b> Includes Music Set 2 and handbells.	<b>08MX0290</b>	<b>\$79.95</b>
<b>Best Value</b>	<b>Handbell Starter Kit 3.</b> Available Summer 2003. Includes Music Set 3 and handbells.	<b>08MX0291</b>	<b>\$79.95</b>

## The Super Heroes Bible

Teaches kids ages 6 to 10 what it takes to be a hero of faith. This full-text Bible in the New International Reader's Version® (the NIV for kids) highlights more than 200 men, women, and kids who displayed super hero characteristics—bravery, faithfulness, honesty, patience, strength, and more. Additional features include 40 full-color illustrated pages, a dictionary to explain meanings of hard words, maps, and reading plans to help keep kids on track for regular time in God's Word. Hard.

**01MX0130**      **\$26.99**



**CALL TODAY**  
**1.800.641.4310**

**FAX TODAY**  
**1.800.328.0294**



Gospel Publishing House  
1445 North Boonville Avenue  
Springfield, Missouri 65802-1894

NONPROFIT ORG.  
U.S. POSTAGE  
**PAID**  
PERMIT NO. 48  
SPRINGFIELD, MO

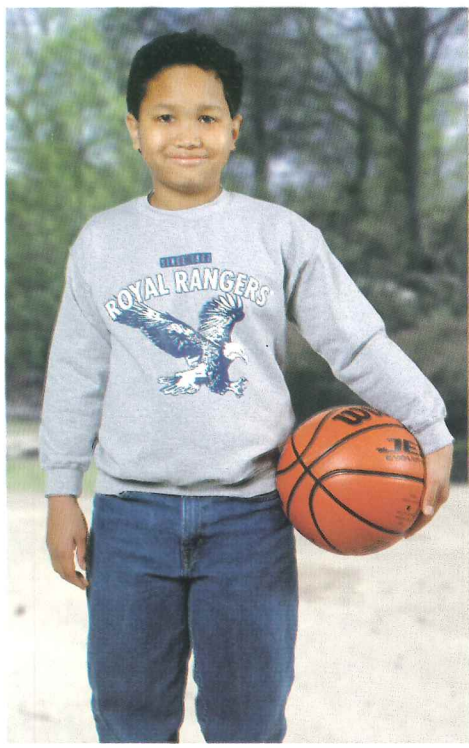

20M 2/03