

FALL 1990

# High Adventure

LEADERS EDITION

A ROYAL RANGERS MAGAZINE  
FOR BOYS

**The Real Top Gun  
Boy Balloonist  
Astronaut David Hilmers  
TV: Blessing or Curse?**







Page 4



Page 7



Page 8



Cover model is Royal Ranger  
Kevin Dawson

# HIGH ADVENTURE

FALL 1990

**The Real Top Gun**

**3**

**And God Created the Heavens**

**7**

**Hiking the Missions Trail**

**8**

**Emergency Flight**

**10**

**Craft**

**12**

**Dare To Dream**

**13**

**TV: Blessing or Curse?**

**14**

Cover Photo by Melvin Snyder

**HIGH ADVENTURE STAFF:**

Ken Hunt, Director of Publications; Marshall Bruner, Editor; Larry Bangle, Art; Ron Day, Layout

**NATIONAL COMMITTEE:**

Silas Gaither, Ken Riemenschneider, Ken Hunt, Paul Stanek

**HIGH ADVENTURE**—Volume 20, Number 2 ISSN (0190-3802) published quarterly by Royal Rangers, 1445 Boonville Avenue, Springfield, MO 65802. Subscription rates: single subscription \$1.75 a year; bundle (minimum of five subscriptions, all mailed to one address) \$1.50 a year. Copyrighted 1990 General Council of the Assemblies of God, Inc., Gospel Publishing House. Printed in USA. Second-class postage paid at Springfield, Mo., and at additional offices. POSTMASTER: Send address changes to High Adventure, 1445 Boonville, Springfield, MO 65802.

MEMBER  EVANGELICAL PRESS ASSOCIATION





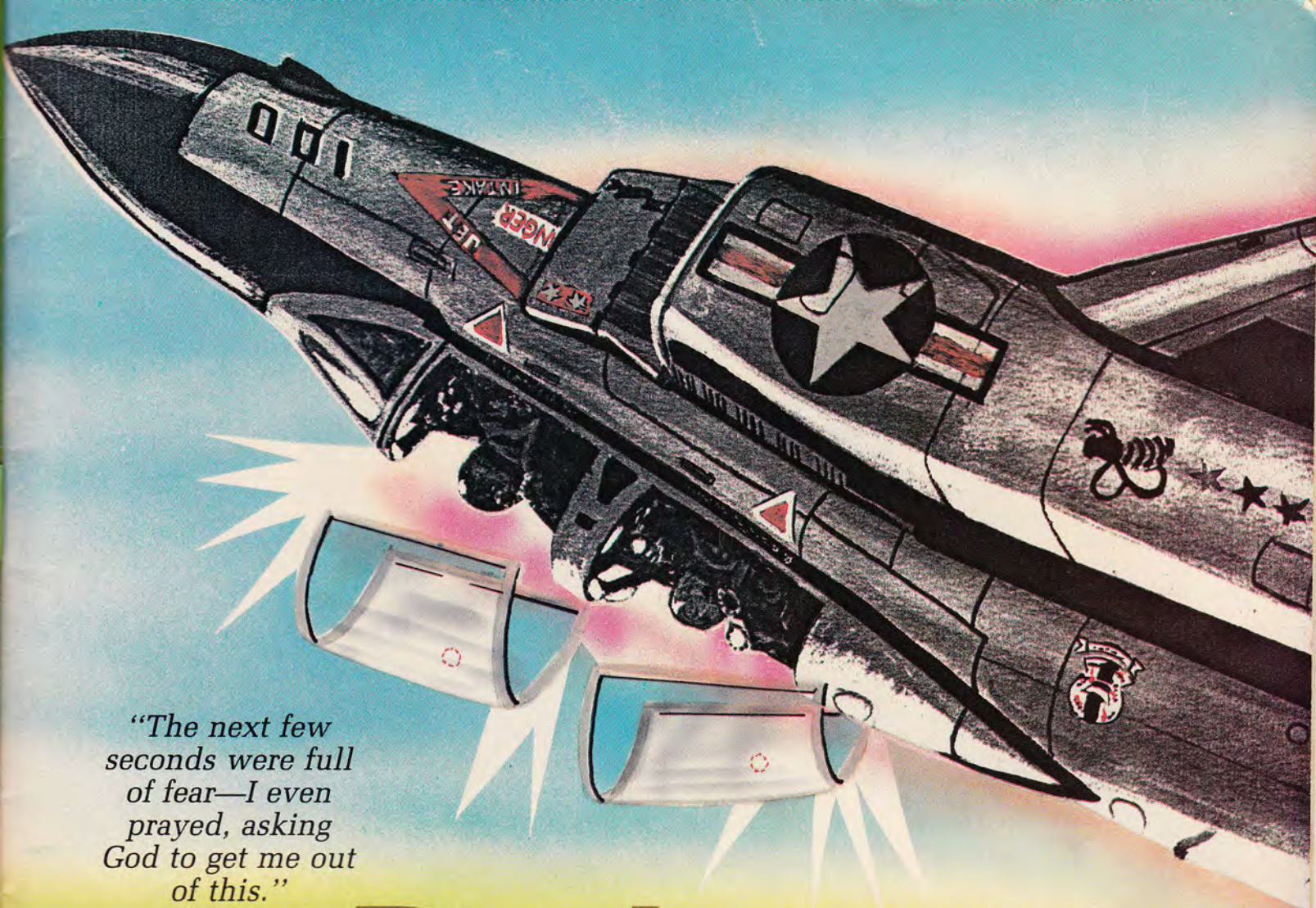

*"The next few seconds were full of fear—I even prayed, asking God to get me out of this."*

# The Real Top Gun

*The airplane fighting sequences of the movie Top Gun were heavily based on Randy Cunningham's experiences as the first U.S. fighter pilot ace in the Vietnam Conflict.*

The year was 1972. The place, Vietnam. Lt. Randy ("Duke") Cunningham had just become the first U.S. fighter pilot ace—the real top gun—in the Vietnam Conflict after shooting down his fifth MiG (enemy fighter plane). His triumph was in defeating one of the enemy's top fighter pilots after several minutes of courageous, seemingly impossible maneuvers and encounters.

Randy had flown mission after mission over Vietnam, dodging bullets and missiles—continually looking into the eyes of death. Yet, suddenly Randy and his buddy Bill ("Irish") Driscoll—the radar intercept officer who occupied the back seat of the two-man F-4 *Phantom*—found themselves faced with something they had never encountered.

Here is Randy's account taken from his book *Fox Two*:

"Glancing over the starboard I watched an SA-2 heading straight for us. Before I could maneuver the SAM [Surface-to-Air Missile] went off. The resultant concussion was not too violent but my head felt like it went down to my stomach. . . .

"About 45 seconds later the aircraft yawed violently to the left. . . .

"The aircraft was burning. . . . I told [Irish] to reselect the ejection sequence handle so that if he decided to go, I wouldn't go with him. . . . 'Okay, Duke,' replied Irish, 'I'm staying with you until you give the word, but I'm placing the ejection handle so that we both go when I eject.'

"The next few seconds were full of fear—I even prayed, asking God to

get me out of this. The aircraft rolled out, and I thought [God] didn't have anything to do with it. Then the F-4 rolled uncontrollably again, and I thought to myself, 'God, I didn't mean it!'

"An explosion ripped through the *Phantom* and I almost ejected, but we were still over land. The radio was full of screams from our buddies to punch out [to bail out from the jet aircraft]. They knew the burning F-4 could explode any second. A-7s and F-4s [fighter planes] were all around us—I caught glimpses of them as we rolled up and down. Any MiG [an enemy fighter jet] wandering within 10 miles of the area would have been sorry; a situation like this gets pilots hopping mad.

"Just as we crossed the coast we

*please turn to page 5*





FRED EVER



lost our last utility system and another violent explosion shook our fighter. A few seconds earlier and we would have been forced to come down in enemy territory. Someone up there must have heard my prayer. At that moment I prayed the classic 'foxhole prayer' and pledged to myself that I would seek to understand and accept Jesus Christ if I made it. . . .

"The F-4 stalled and went into a spin.

"Each revolution I could see land, then ocean; incredible as it may seem, my fear kept me in the aircraft. . . .

" 'We are going to have to get out' finally left my mouth.

" 'Duke, the handle is set . . . when I go, you're going with me. Good luck.'

"I got out, 'Irish e- . . . ' and I heard his seat fire. . . . I heard his canopy go and thought my seat had malfunctioned. As I started to reach for the ejection cord, my seat fired, driving me up the rail and away from *Showtime 100* [Randy's aircraft]."

*Randy and Bill  
were furiously  
jolted from their  
flaming  
aircraft. . . .*

Randy and Bill were furiously jolted from their flaming aircraft when Bill operated the ejection mechanism. Randy's mind was racing as his parachute carried him toward the muddy Red River below. He wondered what he might face if he safely landed and again vowed to change his life-style for the better.

God answered Randy's prayer. Both Randy and Bill survived that mission; it was Randy's last in Vietnam.

During his naval career, Randy "flew 300 combat missions and was awarded the Navy Cross, two Silver Stars, 15 Air Medals and the Purple Heart," states *Fox Two*. "He was also decorated by the South Vietnamese government."

Many call Randy a hero. But to Randy, he was just a guy who did his job very well with the support of a lot of other people.

Randy certainly doesn't consider himself a hero. But among the thousands of U.S. military pilots, he is

one of a small group who have fought well enough to earn the title "ace."

Randy grew up in Shelbina, Missouri, and went with his parents to a local church there. But as Randy became older, he shied away from God; he was looking for excitement. Following high school Randy attended and graduated from the University of Missouri in 1964. He then earned a master's degree the next year.

After college and 2 years of teaching, Randy joined the Navy in 1967. He received flight training at Miramar Naval Air Station, also known as Top Gun, near San Diego, California. Then Randy went to Vietnam.

Randy's first tour of duty was pretty basic. His second, however, was quite the opposite. "His second WestPac tour . . . saw him emerge as the first American ace of the war, the first all-missile ace and the first ace mounted on the F-4," states *Fox Two*.

Randy found the excitement he thought would make his life complete . . . but he was still missing something—Jesus Christ. Randy cried

out to the One who was missing in his life, however, when he was shot down by enemy aircraft in 1972.

"A lot of people make promises to God and don't stick to them," Randy said. "But when something is etched into your mind under that duress, you don't forget those promises."

Randy didn't forget. After Vietnam he came to know Jesus Christ as Savior. Just like his career as a fighter pilot, his decision for Christ was possible because of the support of a lot of others.

People who helped Randy fulfill his promise to God were Hal Lindsey, Johnny Cash, June Carter, and Dan McKinnon. They helped Randy realize that his life had meaning and purpose and that God was the only One who could provide the missing element in his life.

Randy was told in training that belief in God is one of the main things that will sustain men who are shot down in battle. Randy found out that belief in God will also sustain you in life. 

## Lock 'em Up

By Margaret Cheesebro

Match these famous prisoners with the statement that tells something about their lives.

- |                     |   |
|---------------------|---|
| 1. Joseph           | A. He said he was the voice of one crying in the wilderness. A dancer, who pleased King Herod, asked Herod to bring his head to her on a platter. |
| 2. Samson           | B. He was frequently in prison or escaping from people who wanted to harm him because he was spreading the gospel of Jesus Christ in many lands.  |
| 3. Jeremiah         | C. His jealous brothers sold him into slavery. His slave owner's wife lied about him, causing him to be put into jail.                            |
| 4. John the Baptist | D. He was arrested at night in the Garden of Gethsemene after one of his followers betrayed him.  |
| 5. Jesus            | E. This criminal was released during the same Passover season in which Jesus was crucified.   |
| 6. Paul             | F. He was too strong to be captured until the woman he loved betrayed him by telling his enemies to cut his hair.                                 |
| 7. Barabbas         | G. He was a prophet who told the Israelites they lacked love and devotion for God. He was put into a dungeon by a king.                           |

ANSWERS: 1. C, 2. F, 3. G, 4. A, 5. D, 6. B, 7. E



# Edward Warren— The Boy Balloonist

By L. W. Smith

Most people in Baltimore seemed to have gathered for the spectacular event that day in June 1784. Thirteen-year-old Edward Warren was among them. In fact, he was gradually squeezing his way toward the front of the crowd. For once, Edward thought as he ducked under an elbow, being small and unimportant was proving to be helpful.

When Edward reached the front, he finally saw the object everyone was talking about. A huge, cloth bag stretched across the ground. A big, smoky, smelly fire burned near its open end. As the bag filled with hot air, it began to expand and rise. Soon the balloon was inflated to its fullest—36 feet in diameter.

Nearby a big man supervised the activity. Edward recognized him as Peter Carnes, a prominent lawyer in the city. At last Carnes turned to face the waiting crowd. "My friends," he said as he waved his hat with a flourish, "you are about to witness a great moment in the history of these newly United States of America."

The crowd cheered loudly, and Edward joined them. Carnes bowed deeply, then began to speak again. "As you may know, the Messieurs Montgolfier sent up a hot air balloon for the first time just last year in France. We shall do the same thing on American soil today."

Again the crowd roared its approval. The balloon tugged at the ropes holding it to earth—as if it, too, were growing impatient. Several men struggled to hold down the balloon as final adjustments were made.

Then Carnes directed the men, "Release the ropes!" The balloon began to float skyward. As it rose higher and higher, it seemed to lift Edward's dreams with it. Edward knew that manned flights had already occurred in Europe. Perhaps one day he, too, would ride a balloon to the clouds. Finally the balloon bobbed in the air overhead, held in place by a few stout anchor lines.

After awhile the balloon began drifting downward. The entire show was then repeated several times, always with success. Edward watched the whole process in awestruck stillness.

At last Carnes addressed the watching crowd once more: "That concludes the day's experiments. I believe I can now say that the scientific study of flight holds great promise. A balloon such as this one is. . . ."

---

*Edward knew it  
was a great  
achievement. He  
was the first  
American citizen  
to ride in a  
balloon over  
United States soil.*

---

Suddenly, a voice in the crowd interrupted. "It's a mortal danger; that's what I say," yelled a woman. A few other voices shouted their agreement.

"I assure you, madam, that this balloon is quite safe."

"If it's so safe, why don't you ride in it?" shouted a man standing next to Edward.

"An excellent question, my good man," replied Carnes. "I am afraid that the lifting power of this craft is not sufficient for a man of my, er, stature." Carnes patted his belly grandly and grinned.

Most of the crowd laughed. Some started to leave. But Edward had an idea, if only he could muster enough courage to suggest it. Carnes himself turned away and began issuing orders. In a few minutes the balloon would be deflated, then it would be too late.

"Please, sir!" Edward said in a shaky voice. No one seemed to take

notice. Edward tried again, much louder. "Please, sir!" This time Carnes turned his head. "I know it is not my place, and I know that I appear small, although I am 13 years old." Edward took a deep breath. "But it is for this very reason that I may be of service. I would like to volunteer to ride in your balloon."

The man standing next to Edward gasped. Carnes himself appeared shocked. "Do you realize what you are saying, lad?" asked Carnes.

"Yes, sir," Edward answered steadily.

Carnes looked him over in silence for several moments. Edward tried to return the unwavering stare. Meanwhile, excited whispers passed back and forth between other members of the suddenly quiet crowd.

Finally, Carnes spoke to his helpers. The men began preparing a sort of basket in which Edward could ride. Within minutes launch preparations were completed. Edward stepped forward and climbed inside the object.

Almost before Edward knew it, the balloon was sailing. Ten feet, 20 feet, then 30 feet off the ground. Only the anchor lines, still firmly attached to earth, kept the balloon from floating even higher. Edward knew it was a great achievement. He was the first American citizen to ride in a balloon over United States soil.

At last Edward dared to look down. The people far below appeared tiny. Yet, Edward could still hear them. They were cheering and clapping even more wildly than before. Carnes himself was waving and pointing enthusiastically. All eyes were on Edward now.

Edward waved his hat grandly to the crowd. No longer did he feel unimportant. Edward knew that people would remember this day forever. And when they did, he thought, they would also remember Edward Warren. 



# And God Created the Heavens



Photos by NASA

Guess what? A Royal Rangers patch was sent into outer space in February. The patch was flown aboard the U.S. space shuttle *Atlantis* on its mission that lasted February 28-March 4, 1990.

Lieutenant Colonel David C. Hilmer, a Christian and a NASA astronaut, took the Royal Rangers emblem aboard the *Atlantis* during his recent flight into orbit.

David reports: "Launching from the Kennedy Space Center in Florida, *Atlantis* completed 72 orbits of the earth, traveling 1.87 million miles before landing at Edwards Air Force Base in California.

"Some of you may be blessed in the future, as I have, to see from outer space what God has created. Others of you may have a different calling in life. But no matter what you do, you should be of the mind of the apostle Paul when he said, 'And whatever you do, whether in word or deed, do it all in the name of the Lord Jesus, giving thanks to God the Father through him' (Colossians 3:17, NIV).

"I was happy to carry your patch on board the space shuttle *Atlantis* during the mission of STS-36. Thank you for the opportunity to serve you."

David was born on January 28, 1950, in Clinton, Iowa, and his hometown is DeWitt, Iowa. He graduated from the high school there. With high honors David went on to graduate with a mathematics degree in 1968, a master's degree in electrical engi-



ASTRONAUT DAVID C. HILMER

neering in 1977, and an electrical engineering degree from the U.S. Naval Postgraduate School in 1978.

David joined the Marine Corps in July 1972. He was selected to be a NASA astronaut in July 1980 and has since spent several hundreds of hours in training and in orbital operations.

David is married and has two boys. In his spare time he enjoys being with his family, sports, and playing the piano.

Like David you, too, can excel in

life by putting God first in all you do, by reading His Word, by honoring your parents, and by applying yourself in school.

You may or may not become an astronaut. You may or may not grow up to have a successful job. But the most important thing in life is not success, fame, or money; it's God! And don't forget David's advice: "No matter what you do . . . 'do it all in the name of the Lord Jesus. . .'"





## HIKING The MISSION TRAIL

By Anthony (Tony) L. McCreary,  
Home Missions missionary to  
Philadelphia

**I**t was a gray Saturday morning, but laughter could be heard as children listened to stories about Jesus. This was at the Super Snoopy Saturday Sunday school in North Philadelphia, a Puerto Rican and black ghetto area.

That morning some of the boys and girls became born-again Christians at New Life Church.

Every Saturday, upon hearing the church's bullhorn, dirty-faced and sometimes scantily dressed children would stream out of their sagging, often abandoned homes. They climbed impatiently into an old 1971 red school bus that carried them to the shabby warehouse—this their church.

The church sits across the street from a junkyard filled with rundown cars and trucks. Not your common church setting by any stretch of the imagination.

Then in March 1990 our staff began a new approach to evangelism: Super Snoopy sidewalk Sunday school. By using converted rental trucks, we now hold 21 Sunday school services throughout North Philadelphia. As we go from neighborhood to neighborhood, we open up one side of each truck and use the truck beds for stages.

When we first began the Super Snoopy Sunday school, we were ministering to 235 kids. But with the mobile Sunday school, we are now telling more than 4,000 kids about Jesus.

New Life Church is also reaching kids and adults during regular Sunday, Wednesday, and Friday services. About 100 boys at New Life



## Reaching the Kids of North Philadelphia

Church are involved in Royal Rangers. This program has become a major key to reaching boys for Christ. The reason: Many boys in the ghettos of North Philadelphia have no father at home. The Royal Rangers program provides the needed male role model such boys lack.

Few people would imagine such a mission field existing in the United States. But there it is, seemingly forgotten by humanity. But not so with God!

The sin of North Philadelphia must have weighed heavily upon God's heart in January 1985. He began to awaken me daily at 5 a.m. during a time of fasting and prayer. Some mornings I could almost hear voices of the lost souls crying out from hell. The sound lingered in my mind throughout the day.

I felt God was calling me and my family to Philadelphia. A Scripture verse, "For the dark places of the earth are full of the habitations of cruelty" (Psalm 74:20), was quickened to my heart. So I went.

I found shocking circumstances in North Philadelphia. At every street corner were cocaine and crack drug dealers. I soon discovered that mothers commonly sold their children's clothing and food or went without heat so they could buy drugs. It was apparent children were uncared for in the neighborhood.

Even the flop-eared, lovable Snoopy we used to capture the imagination of the neighborhood was met with much suspicion.

"At first I thought Pastor was a cop coming to bust the drug dealers," said 11-year-old Shareef Holmes.



# High Adventure FALL 1990 Leader

2

Prayer Availeth Much

*One-on-One*

4

Somebody Prayed

6

Born To Fly

8

News

10

Devotion for Boys

12

Craft

*Marshall F. Brumer*

The words "the history of aviation reads like an exciting adventure story" remain as true today as they did when first published in the *Air-Sea-Trail Rangers Handbook*. Man has long desired to fly like a bird in God's blue heavens. His thirst for skyward adventure has remained unquenched and has been well captured in history books.

For this reason and that boys will become inspired and drawn closer to God, this issue was born. National Royal Rangers leaders had many months ago initiated the idea of developing an aviation-oriented *High Adventure* magazine. Then God began to work. He provided the means to produce a story that could direct the eternal destiny of the thousands of boys who will read it. This story—see *High Adventure*, pages 3-5—is about Randy Cunningham. Randy became the first U.S. Navy fighter pilot during the Vietnam Conflict to earn the title "ace." Randy's calling out to God during that time set into motion a series of events that brought him to the saving knowledge of Jesus Christ.

In rapid succession the Lord continued to open doors, making it possible for both *High Adventure* and *High Adventure Leader* to bulge with aviation-related articles. Following this page are true accounts of how God intervened through the act of prayer. You will also read of historic and ongoing events that can be applied to everyday Christian principles.

I trust that the contents of this magazine will not only be useful to you during your outpost meetings, but will also serve as a tool to "reach, teach, and keep boys for Christ." Thanks to everyone who helped make this issue possible.

High Adventure Editor



# Prayer Availeth Much

By Jim Kennedy, FCF field advisor

I remember the morning well. The day was October 9, 1972. As an Army helicopter pilot, I had been assigned to fly with a combat aviation group in the Republic of Vietnam.

Our group was working a "troops in contact" mission. Some soldiers had been under enemy fire and were in dire need of aerial fire support. I was the aircraft commander flying as the wingman in the second pair of

AH-1 Cobra gunships. Flying with me was Carrol Kern, a warrant officer who was training to become an aircraft commander.

During our attack on enemy positions, the intensity of ground fire became overwhelming. I attempted to pull out from our attack dive, but a round of enemy fire severed the tail rotor drive shaft of our aircraft. The craft began to spin, yet we managed to make a semi-controlled crash into

a flooded area. Carrol exited his flight compartment, only to find that I was trapped.

The Cobra began to sink as it filled with water. Carrol managed to smash his way into the cockpit and to help me out. By then we were standing on part of the aircraft that was slightly beneath water.

I took out my survival radio and attempted to use it, but it had been damaged. Knowing we had become

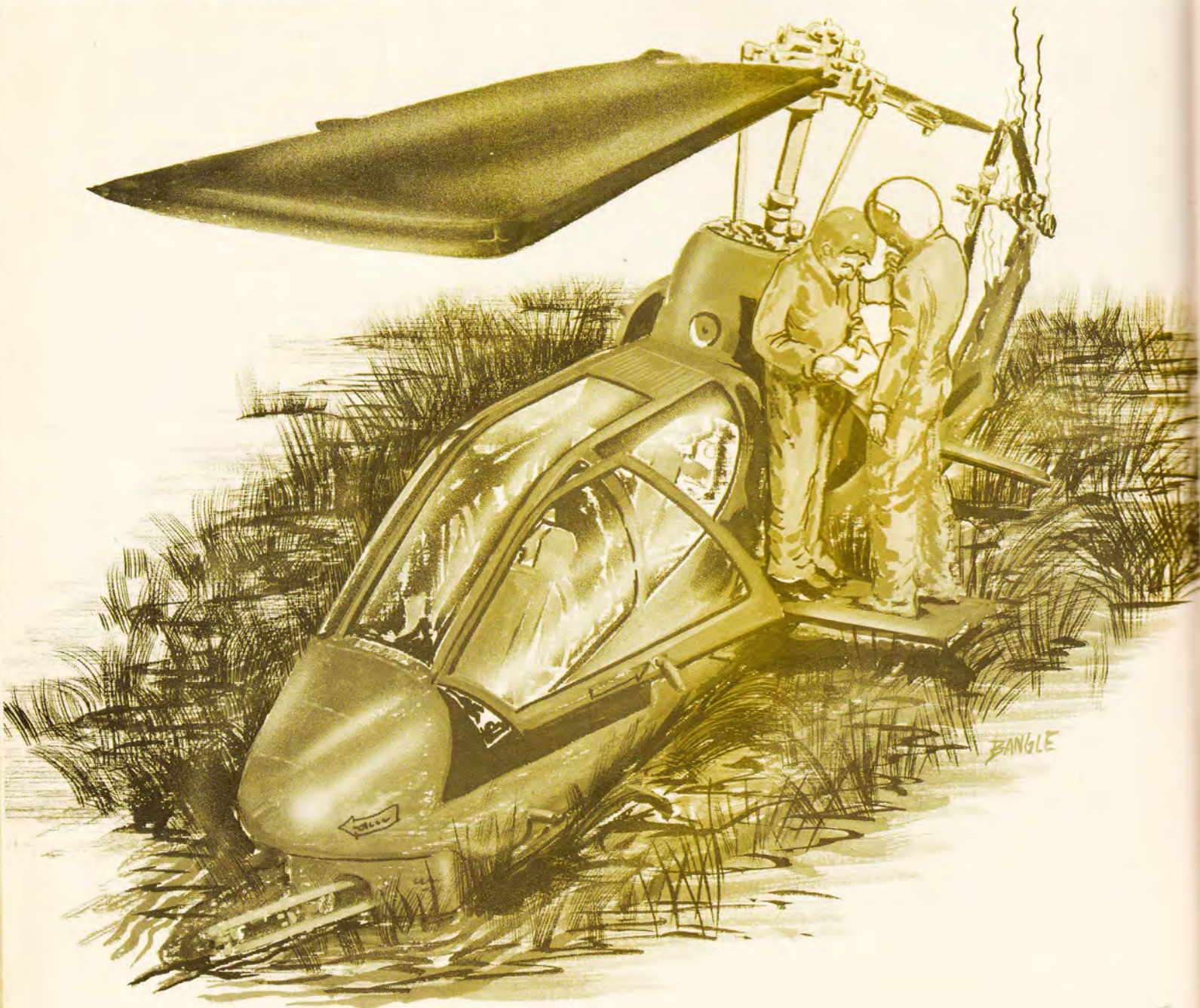



separated from the other aircraft and unsure of our safety, we decided to swim.

One calamity followed another, however, as Carrol jumped into the water. He landed on a portion of submerged wreckage and injured himself. I quickly managed to pull Carrol back to the downed aircraft. With the nearest land being more than half a mile away, the idea of swimming had suddenly been squelched.

More than an hour passed as we clung to the submerged wreckage. Finally, an aircraft crew spotted us. With complete disregard to potential danger, the pilot, Ron Willis, came to our rescue. Safe at last!

*The craft began to spin, yet we managed to make a semi-controlled crash into a flooded area.*

Little did I then know that the Lord had set into motion this and other events that would make a dynamic impact on my life. Shortly after I had departed for Vietnam months earlier, my wife Glenda had begun to attend an Assemblies of God church in Georgia. She had been saved only a short time that October day in 1972 when the Spirit of the Lord woke her and impressed her to pray for me—an unbeliever.

In a vision God showed Glenda the area where Carrol and I had crashed. Glenda, after praying before the Lord for some time, then felt a release in her spirit. She knew I was safe.

Though I didn't know Christ as my Savior that day, He still loved me and kept His loving hand on me. I later returned home from war, and Glenda continued to pray for my salvation. Once again her prayers were answered. On October 23, 1973, I accepted Christ as Lord.

One day as Glenda and I were home looking at some photos I had taken in Vietnam, she exclaimed, "That's the area I saw!" The photo at which she was looking had been taken of the area where Carrol and I had crashed in October 1972.

I praise God for a wife who was and is obedient to the call of intercessory prayer.

*Editor's note: Jim Kennedy and Carrol Kern were awarded the Distinguished Flying Cross for heroism.*

# Men of the Bible

By Helen Friesen

Place the names of men from the Bible in this puzzle. A = Across, D = Down.

- 1A: Adam's and Eve's second son (Genesis 4:2).
- 2A: Fifteenth book of the Old Testament.
- 5A: A Philistine king of Gerar (Genesis 20:1-18).
- 6A: He was the father of Caleb (Joshua 14:14).
- 8A: Name of the third book in the New Testament.
- 9A: A son born to Adam and Eve

after Abel's death (Genesis 4:25).

- 1D: Steward over the house of Elah (1 Kings 16:8-10).
- 3D: Father of Aholibamah, who was one of Esau's wives (Genesis 36:2).
- 4D: Descendent of Gershom, ruler of treasures in house of God (1 Chronicles 23:16).
- 6D: The book in the Old Testament after Hosea.
- 7D: Second son of Canaan (Genesis 10:15).

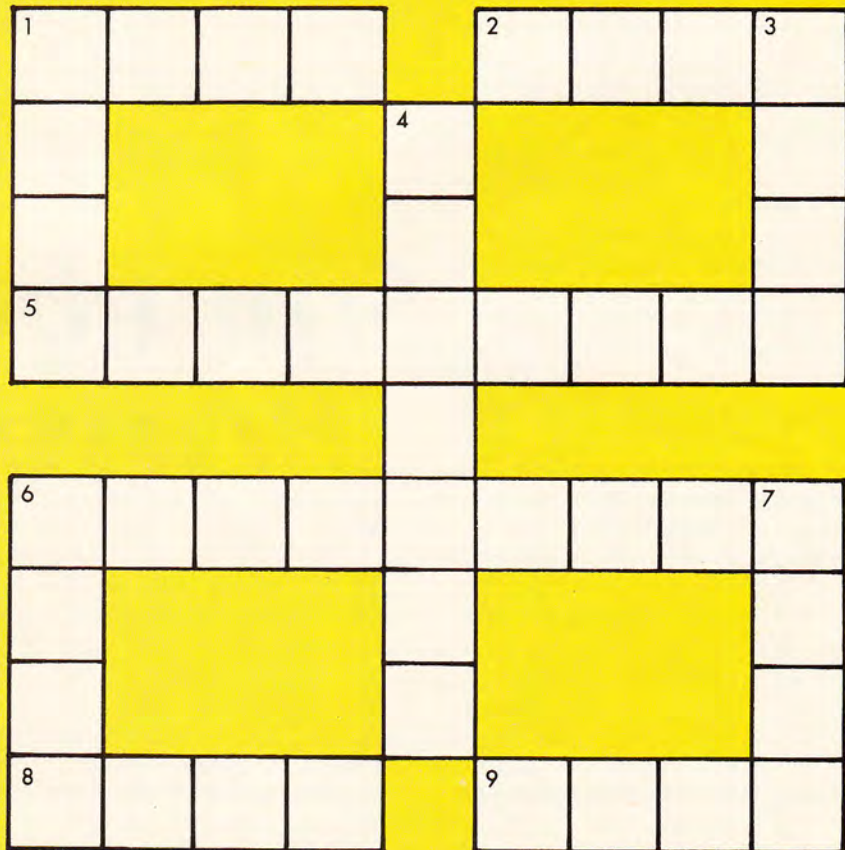

**Answers:**

- 1A: Abel
- 2A: Ezra
- 5A: Abimelech
- 6A: Jephunneh
- 8A: Luke
- 9A: Seth
- 1D: Arza
- 3D: Anah
- 4D: Shebuel
- 6D: Joel
- 7D: Heth



## Prayer . . .

**B**e looking for open land in case of an emergency landing," came the pilot's haunting words. The single-engine Cessna vibrated as its engine malfunctioned and the plane lost altitude. While struggling to maintain control, the pilot grabbed a map and radioed his location to a Mission Aviation Fellowship ground control in Zaire, Central Africa.

*Oh, no,* Peggy thought, her panic rising. *This can't be happening to us.*

Until then, the flight had been routine for Missionaries Ernie and Margorie Jones, Peggy Johnson, and Joann Butrin during their flight from Isiro, Zaire, to the National General Conference in Bodi.

"I'm sorry, but we can't turn back. There's nothing but solid jungle behind us," the pilot continued. "I'm going to change our destination."

Struggling for control, the pilot zig-zagged the plane while he and Ernie searched for a place to land. Prayer began to resound in the plane's cabin as the three ladies sought God. The result had to be under His control . . . nothing else worked.

Peggy fought to pray but couldn't because her thoughts were stifled by fear. *I'm so scared I can hardly pray,* she thought. *Lord, please lay us on the hearts of Christians to pray for us—even if it means waking them up!*

The plane kept a slow pace for 30 minutes while the men searched for a landing place. Minutes seemed like hours to the passengers as the engine continued to malfunction.

It was nearing 9 a.m. in Zaire when God woke a Christian in the United States at 1 a.m. to pray for Peggy. The man knew only that she was in some life-threatening danger. The Holy Spirit urged him to continue to pray for some time. Then his burden lifted.

The engine sounded as though it



# Somebody Prayed

could stop at any moment, but God intervened. The pilot spotted a landing site in Dungu and nursed the plane to the runway. Slowly, the plane circled twice then landed . . . SAFELY! The applause of praise to God filled the plane's cabin.

Four missionaries and one pilot sighed as their feet touched solid ground. The pilot searched the Cessna engine, then approached the weak-kneed passengers with a piece of broken tubing in his hand.

"The fuel injection line to the engine's sixth cylinder broke, and fuel had been pouring over the engine for 30 minutes," the pilot said. Once again the thankful passengers praised

God for His goodness.

What kept the hot engine from exploding? How did the passengers manage to escape against such odds? Under normal circumstances the engine should have burst into flames in midair.

"I'm convinced," said Peggy, "that God placed us on several hearts at home during those hours of need. It's a kind of mystery and ministry of the family of God."

Somebody prayed . . . and God heard. 





# The Thunderbirds

## Devotion for Boys

Photo by Stephenie Slahor

By Dr. Stephenie Slahor

**P**residents, prime ministers, celebrities, and fans have been thrilled by their maneuvers performed in a carefully planned show of flying skill. They are the Thunderbirds.

Since the team was formed in 1953, the Thunderbirds have flown in shows throughout the United States and in 52 other countries. The Thunderbirds have flown about 3,000 performances before a total of some 224 million people.

Each of the 11 Thunderbird members had been carefully screened and chosen from among many hundreds of U.S. Air Force pilots who had applied for the volunteer program. Six of the squadron members are pilots; three are support officers. The remaining two members are involved in logistics and narration of the shows.

With the many qualified pilots in the U.S. Air Force, one can easily understand how talented a person must be to become a Thunderbird. After semifinalists have been selected, they may accompany the squadron during a few tours. The finalists then go to Nellis Air Force Base in Nevada for more interviews, airmanship tests, and medical tests. Once picked to join the team, the new officers serve 2 years with the Thunderbirds.

Flying the jets is only a portion of what is required to present the Thunderbirds show. Many support people are needed to carry out the other jobs that make the show a success.

About 130 enlisted U.S. Air Force personnel assist the flying team. For example, some of the behind-the-

scene workers handle aircraft maintenance, public affairs, operations, supply, life support, communications, administration, photography, and graphics.

The maintenance people ensure that the jets are safe and ready to fly. The operations people reserve air space for training sessions and the shows. The communications personnel check the public address systems so the audiences can understand the narrator. The public affairs staff writes press releases about the show, the jets, and the people involved in the show. The photographers take action shots to be used for publications about the Thunderbirds. Supply people order parts and equipment that may be needed by anyone.

Many hours of practice and preparation are put in by the Thunderbird team and their supporting workers. Everything must be right—timing, speed, position, entry and exit points, coordination, and the numerous other details that make up a show.

Then comes the Thunderbirds show. The public watches in awe as the F-16 Fighting Falcon jets swoop across the sky with great speed and agility. The public leaves not thinking of the many hours of preparation, but that the Thunderbirds are a competent, highly skilled flying team.

It's an important job, and one that the fans certainly appreciate.

### Editor's note:

Just as many members must work together to make the Thunderbirds show a success, so must the Christian body work together as a team so the

Lord can be glorified in all His splendor. And all Christians have an important role to play on Christ's team! We *must* do our part in spreading the good news about Jesus.

Few boys and girls at school really know or understand that Jesus loves them. Perhaps they haven't been told that Jesus died for them. Maybe their parents aren't Christians. Or maybe someone like you hasn't taken the time to tell them. We must work together to spread the good news about Jesus.

Team effort is also vital in your local church. Though the pastor is the most visible, the strength of the church greatly depends on its members. Sunday school workers are needed to teach lessons. Ushers are needed to greet visitors and to seat them. Layworkers are needed to visit the sick and the imprisoned. Janitors are needed to clean God's holy house. Commanders are needed to lead the Royal Rangers. You are needed to encourage, to love, and to help others.

You may not think you are an important member of God's team, but you are! The body of Christ is not complete without you and your help.

Just like the Thunderbirds cannot perform without the aid of their mechanics and numerous other helpers, likewise God's body cannot effectively function without you.

Take a few moments to read 1 Corinthians 12. Meditate on these verses and realize your importance as a member of God's team. Now take a pencil and paper. Mark today's date on the upper right-hand corner.

Next, form two columns—the left labeled "Team Member Today," the second marked "Team Member To Be." In the left column list ways you are actively involved in God's team. When you finish, list on the right-hand column new ways you can be a better team member in the future.

Now pray and ask the Lord to help you to keep your personal commitment to Him. After you finish, put the paper in your Bible, and read it at least once a week. This will help you keep up your team spirit and to remember the commitment you made to the Lord on the date written on your paper.







# Born To Fly

By George H. Davis

**I**t all started when I was 8 years old and had no idea I would ever pilot a plane. My mother challenged me to read the entire Bible in a year. She promised me that if I did, she would give me my very own Bible—the kind with the words of Jesus in red and the pictures in color!

That year the Bible became the Book of God's precious promises to me. My favorite promise became, "The eternal God is thy refuge, and underneath are the everlasting arms" (Deuteronomy 33:27). What Scripture verse could be more appropriate for a pilot?

Looking back over the years, however, I see something even more meaningful to me than the bare promise. I see the implication God knew, even when I was a boy, that one day I would become a missionary pilot. Airborne. I was born to fly!

## God's Promises

God's promises are sure. He has said, "Lo, I am with you alway" (Matthew 28:20). As a pilot I can say,

"High, He is with me always too."

For instance, once my wife and I had an emergency landing in Gran Chaco, Bolivia. Due to a misunderstanding with officials, we were detained overnight in jail. We were not fearful because we remembered God's promise to be with us always. We were very pleased the next morning, of course, when the misunderstanding was cleared up and we were permitted to leave.

Another of God's promises is, "My God shall supply all your need" (Philippians 4:19). He has done this in miraculous ways more than once during my flying career.

On my first flight across Panama in a single-engine Cessna, I was forced to change routes due to bad weather. My fuel supply became critically low. In desperation I called Panama radio. My plea for help was quickly answered by the U.S. Air Force.

"Cessna, November, 7382, Mike [my airplane identification number N7382M], what is your problem?" asked the airman.

"We're almost out of fuel," I re-

plied. "Is there a field nearby that has a fuel supply?"

"We have you on radar," answered the man. "You're just 30 miles from Rio Hato. It is marked closed, but you're permitted to land. We'll send a Beaver airplane to escort you and a helicopter to fish you out of the water if you don't make it."

When I landed, a big semitrailer gas truck came up alongside my plane. Two GIs from Texas asked politely, "What can we do for you?"

"Fill 'er up," I replied. The next problem was to get the big nozzle leading from their truck into the little filler hole of my gas tank. When they finished I asked coyly, "How much do I owe you?"

One of the men grinned and said, "We never charge for the planes we service." I wished I had a bigger tank! I was reminded how God had sent the ravens to Elijah by the brook with his daily bread while he was in exile. That was a miracle. But I needed gasoline worse than I needed bread. To me the fuel He had supplied in Panama was just as miraculous.



## God, Man, and Airplanes

I am convinced that God intended many of us to fly in planes and that He designed the earth and the heavens with this in mind. For example, God planted the magnetic North Pole as a universal reference point to orient our compasses and to guide us. He also designed barometric pressure in such a way that it can influence the airplane altimeter, so we pilots can know how high we are flying.

The airplane has taught me many spiritual and philosophical princi-

***"I am convinced  
that God intended  
many of us to fly  
in planes. . . ."***

ples. Certainly it illustrates the principle of divine-human cooperation. Flying allows us to develop our skills, knowledge, judgment, and discipline. Never should we become presumptuous.

God's promise to be with us, to protect us, and to watch over us is never an excuse for us to be careless. While God has no accidents or tragedies or emergencies, we do from time to time. All of life's experiences are filled with dangers, risks, and problems. But what a team we are with God when we offer Him our skills and obedience and when He offers us His wisdom and protection!

I have found that when I have checked the weather and have planned my flight then find myself in trouble, I prayed with more faith than if I blundered into problems knowingly. Faith in God is no excuse for recklessness on our part. This principle can be applied on the playground, in sports, or in any activity.

Even the instruments on the airplane panel can teach us some interesting points of philosophy. For instance, the plane's "attitude indicator" (formerly called "artificial horizon") can teach us that we should maintain a good attitude. In comparison, our attitude as to how we confront life can be as important as the flying attitude of a plane.

Some time ago I was planning a long trip of several thousand miles.

The distance seemed overwhelming. Then I remembered that I did not have to make the entire trip in one flight or in one day. It could be divided up into segments or legs of shorter duration. In other words, I adjusted my attitude. I developed the philosophy that I only had to fly to the next airport.

That is the way life is. Just live one day at a time. God has promised, "As thy days, so shall thy strength be" (Deuteronomy 33:25). Along life's journey I have said to others, "Don't change course in the valley."

During discouraging times we may be tempted to make a 180 degree turn and go back to where we began. But if we plod ahead until we come over the next hill, we can escape from the valley because our goal is much nearer. Therefore, we can commit our ways and our days to Him every day.

## Our Goal

Always have a goal in life. Just as a pilot must have a definite destination on his flight plan, so should each Christian have a goal.

One flight student put on his flight plan "E.D." His instructor quizzed him, "What do you mean by that?"

"That means estimated destination," he replied. One will never get to the right place until he knows where he is going.

Flying has taught me to prepare myself the best I can, to commit my plans to God like a flight plan, to listen for His voice like I listen for the voice from an aviaional control center, and to remember that God will be with me always.

Likewise, may we all be prepared for our journey in life, stay on course, and maintain constant radio contact with the Master of the Control Tower—the Lord God. He knows what lies ahead and our final destination. But . . . it is up to us to stay in tune and on course.

Happy flying!



*George Davis has been an Assemblies of God missionary for more than 33 years. He also serves as a special aide-de-camp for the Royal Rangers.*



# Around the Universe

By Martha J. Beckman

**H**ow is your knowledge on many different subjects? For a taste of miscellany, choose the right answer for the 12 topics below and find out. Ten correct makes you "well-rounded."

1. World War I began in . . . 1900, 1908, 1914, or 1939?
2. The sewing machine was invented by . . . Jacob Singer, Elias Howe, Betsy Ross, or John Deere?
3. A baker's dozen is . . . 12, 13, 20, or 24?
4. "The Star-Spangled Banner" was written by . . . George Gershwin, Stephen Foster, Francis Scott Key, or Jenny Lind?
5. The first vice president of the United States was . . . Alexander Hamilton, George Washington, John Kennedy, or John Adams?
6. "Seward's Folly" refers to what state . . . Alaska, Minnesota, California, or Hawaii?
7. A calorie is a measure of . . . heat, volume, length, or weight?
8. The planet nearest the sun is . . . Earth, Pluto, Mercury, or Venus?
9. The largest nation in the world is . . . Brazil, Japan, USSR, or USA?
10. The first explorer to sail around the world was . . . Columbus, Magellan, Cortez, or DaGama?
11. *Treasure Island* was written by . . . Charles Dickens, Abraham Lincoln, R. L. Stevenson, or Louisa Mae Alcott?
12. "I came, I saw, I conquered," is recognized as familiar from what language . . . Latin, English, Spanish, or Hungarian?

## Answers:

1914, Howe, 13, Key, Adams, Alaska, heat, Mercury, USSR, Magellan, Stevenson, Latin



# Royal Rangers Leaders Gather for 1990 National Council

The words *unity* and *vision* for reaching, teaching, and keeping boys for Christ rang clear March 14-16 as 248 Royal Rangers leaders and wives gathered in Springfield, Mo., for the 1990 National Royal Rangers Council.

"There was a real sense of cooperation at this council," stated National Commander Ken Hunt. "And because of the God-anointed, dedicated councilmen, the wheels were set in motion to see great things come about for Christ in the years to come."

At the onset of the meetings members elected National Council officers. David Wharton, of Mt. Juliet, Tenn., was voted president; the Rev. Mark Gentry, pastor of Faith A/G in Fort Smith, Ark., was voted first vice president; and James Barger, of Findlay, Ohio, was voted second vice president.

During sessions the Council ratified several motions presented by the Executive Royal Rangers Committee that would strengthen the evangelistic outreach to boys.

The motion was passed to implement a Decade of Harvest Task Force Committee of about six men. The committee will formulate Decade of Harvest goals and implement ways of achieving them.

During the Council Commander Hunt shared his vision to begin a strong missions thrust in the near future. Light-for-the-Lost was a possible means of missions involvement Commander Hunt discussed.

The Council also approved to appoint a Constitution and Bylaws Committee. The committee will study and strengthen the existing Royal Rangers *Constitution and Bylaws*.

Extensively discussed was the 1990 International Camporama, which was held June 26-30. About 3,500 boys and men attended the camping excursion at the National Royal Rangers Training Center near Eagle Rock, Mo.

Another ratification of the Council is to present the Royal Ranger of the Year award by region. The provision allows eight boys to receive the award. The Council also approved suggested revisions of the Frontiersman Camping Fraternity program. As part of this change, the special honor society was renamed the Frontiersmen Camping Fellowship.

Among other items addressed on the Council floor were the topics of child abuse prevention and the church and



A time of special prayer for Nat. Comm. Ken Hunt and his wife Sharon (both center) during the opening service of the 1990 National Royal Rangers Council.

Photo by Ruben Gonzalez

law. Each council day ended with special services.

During his March 16 message Commander Hunt inspired and challenged the National Council with his message entitled "Prepare ye the way of the Lord." In conveying the urgency to evangelize boys for Christ, Commander Hunt spoke on four main topics: our mission, our preparation, our vision, and our focus.

"The Council was a tremendous success," said Commander Hunt. "God has sent us forth with new goals and a new vision."

"Along with our Decade of Harvest Committee and our reorganization attempts to strengthen the Royal Rangers program, I truly believe we are going to touch the world for Jesus Christ."

## Florida Air Rangers Flight School Gains Popularity



Above: Participants of the first Air Rangers, Inc. flight school.

The article below exemplifies how Royal Rangers in one district are learning about aviation. The program is not sponsored by the Peninsular Florida District or by the national Royal Rangers office.

An Air Rangers flying school in Wauchula, Fla., is gradually gaining nationwide attention after nearly a year of existence.

In December 1989 an Air Rangers flying school was conceived in Wauchula, following 4 years of weekend at-

tempts to teach Royal Rangers the skill of flying an airplane.

According to the Rev. Ed White, Royal Rangers Southeast regional coordinator, the Intensified Aeronautical Training School was held December 26-31 at the Wauchula Municipal Airport in Wauchula. RVs served as lodging and eating facilities. A cook was also provided. The staff and students remained on the training grounds for the duration of the school.

Seven students completed the course taught by three in-



structors, said White. Three airplanes were used for training.

From 8 a.m. until 11 p.m. each day the students underwent three phases of training: 14 hours of video flight training, basic training on airplane mechanics, and 12 hours of flight training in the air. The students were then given a written examination—all passed.

On the final day of the flight school, each student flew solo. "I'd never seen so much excitement as when the students landed their planes after soloing," said White. "One student, when finishing his solo, threw up his hands and yelled, 'Praise the Lord! I made it.' That was the basic reaction of each student."

For successfully completing the program, each student received a certificate issued by the Air Rangers, Inc.

According to White the Royal Rangers executive committee of the Peninsular Florida District presented the concept of a nonprofit flying school to their district officials. The district leaders approved the program wholeheartedly.

White continued by stating that he and others then purchased liability insurance, consulted with attorneys, and covered every legal basis before instigating the program. They then initiated the name Air Rangers, Inc., under the premises that chapters can be begun in various locations of the United States.

The turning point for the Air Rangers, Inc., White said, was in November last year. At the Royal Rangers Commanders Conference, White and others distributed fliers about the newly conceived Intensified Aeronautical Training School.

During the conference the need to purchase an airplane for the Air Rangers, Inc., was presented to the constituents.

"Immediately someone spoke up and said, 'Let's buy it!'" said White. "So we took up pledges and were able to purchase a Cessna airplane."

Three airplanes were needed to have an effective flight training school, said White. That need was quickly met. Soon after the November conference an airplane fuselage became available to the

Air Rangers, Inc., for \$850. About a week later a man donated the needed parts to the fuselage to assemble an airplane. By the first week of December, the Men's Ministries of the Peninsular Florida District purchased an airplane, which will be leased to the Air Rangers, Inc., during flight schools.

"We've had a lot of inquiries about the flight school," stated White. "We're now preparing to hold two flight schools per year. Each school will be 6 days in duration."

According to White individuals in other states have expressed an interest in beginning Air Rangers, Inc., chapters in their states.

## Texas Royal Rangers Promote Space '89



Photo by Fred Dickerson

Royal Ranger Joe Ruiz, Outpost 67, poses behind life-size photograph at the NASA space center near Houston.

For the second consecutive year the San Antonio section and the San Juancito section in Texas have consolidated their efforts to hold a Royal Rangers outing (called "Space '89") at the Lyndon B. Johnson Space Center near Houston, Tex.

In November 1989 the two sections—consisting of about 700 Royal Rangers boys, leaders, and parents—gathered for an exclusive tour of areas at the space center.

According to Commander John Crowley—Outpost 175 in Houston—the tour began by

meeting a NASA astronaut. Lt. Col. David Hilmers (see "Royal Rangers Patch Reaches Outer Space") spoke to the group for 15 minutes about the space program. He also gave his Christian testimony.

Crowley, who is chief of the Shuttle Landing Support Division for NASA, said the Royal Rangers were then given a tour of the Missions Control Center. There they were permitted to view the hub of the Control Center. Among other unique opportunities, the Royal Rangers were allowed to go inside the mock space

shuttle *Freedom*.

Crowley noted an intensified interest in outer space among Royal Rangers in the South Texas District. The theme for the district's powwow in April was "Rendezvous in Space."

During past and present years, Crowley, an Air Force pilot himself, has been actively involved in promoting aviation at powwows and sectional meetings. Boys are being given opportunities to participate in fly-ins during powwows and to ride in airplanes at sectional gatherings.

## Royal Rangers Patch Reached Outer Space

A Royal Rangers patch was flown aboard the U.S. space shuttle *Atlantis* on its February 28-March 4, 1990 mission.

"I was happy to carry your patch aboard the space shuttle *Atlantis* during the mission of STS-38," stated NASA Astronaut David Hilmers, who claims Christ as Lord. "Launching from the Kennedy Space Center in Florida, *Atlantis* completed 72 orbits of the earth, traveling 1.87 million miles before landing at Edwards Air Force Base in California.

"Some of you may be blessed in the future, as I have, to see from outer space what God has created," Hilmers concluded. "Thank you for this opportunity to have served you."

Note of interest: According to Senior Commander Bill McMillan—Outpost 216, Deer Park, Tex.—a Royal Rangers patch has also been taken to the South Pole during a recent excursion. Thanks to Commander McMillan for supplying the above information.



## Devotion for Boys

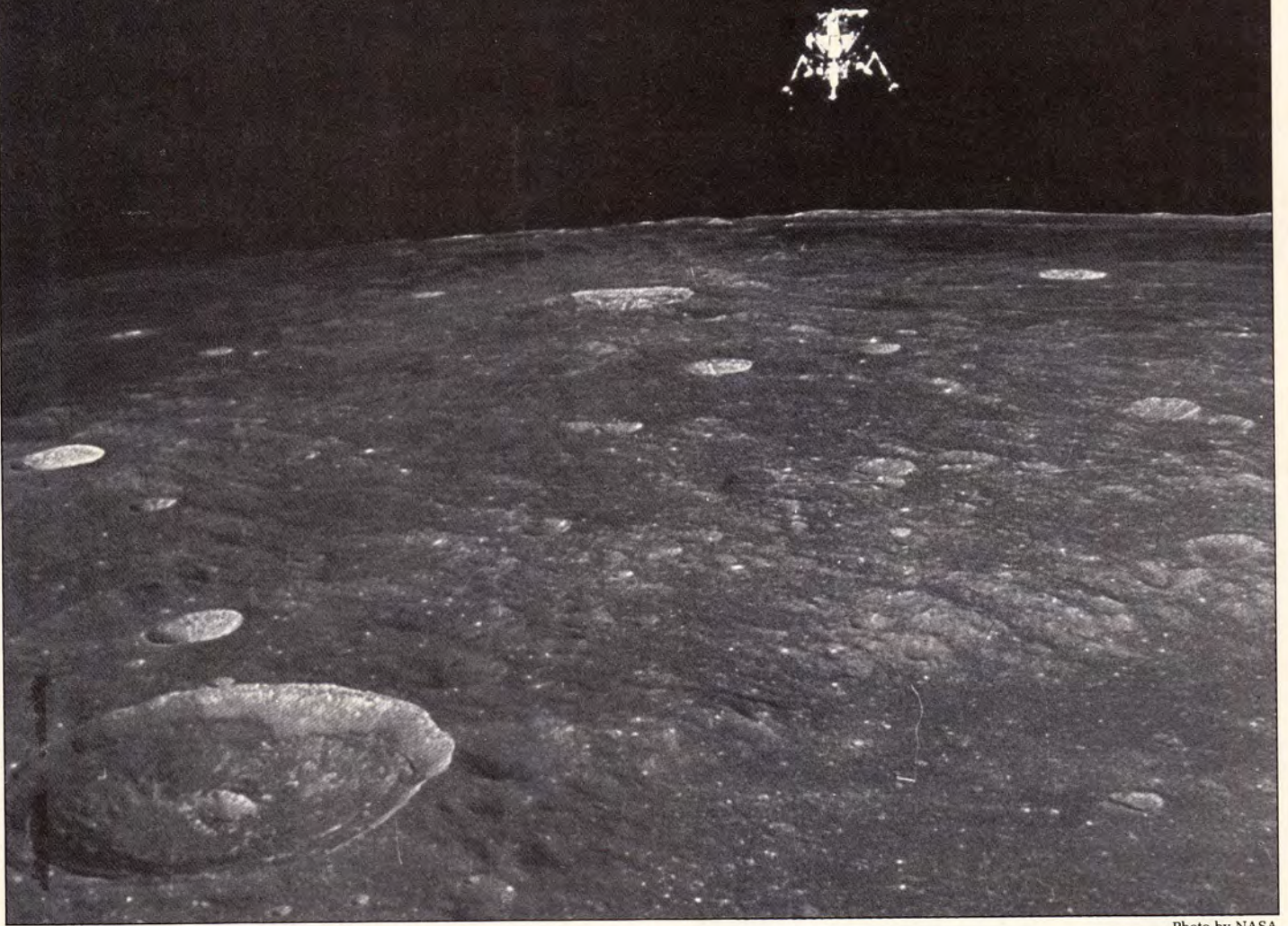

Photo by NASA

# Tranquility Base

By Michelle Lewis Starr

In 1969 two spacecraft lifted from earth in a head-to-head sprint for the moon. The *Luna 15* rose from the Baikonur Cosmodrome in Russia, the *Apollo 11* from Cape Kennedy in the United States. Their missions were identical: make a soft landing on the moon, plant the national flag, retrieve lunar rock and soil samples, and return cargo and crew safely to earth.

The *Luna 15* crashed into the moon. The *Apollo 11* accomplished all objectives. The difference between fail-

ure and success in the space race turned out to be the difference in the guidance systems employed.

The *Luna 15* was an unmanned space probe, loaded with on-board computers and robotics. The *Apollo 11* consisted of three modules. The command module housed a three-man crew. The service module contained the power systems. The third was the lunar excursion module, named *Eagle*. The *Eagle* was designed to ferry two of the three astronauts from the command and service

module to and from the lunar surface. Both the descent to and ascent from the moon's surface were made with the aid of a sophisticated guidance and navigation system.

The heart of this system was an on-board computer. It analyzed input from the altimeter. The *Eagle's* altimeter bounced radio signals off the moon, and the computer read the echoes. By measuring the time intervals between the echoes, the computer could determine the distance from the *Eagle* to the lunar surface.



By examining the shapes of those echoes, the computer could determine the type of landscape on which the *Eagle* was about to land.

Enough fuel was on board to allow for 2 minutes of hover time. If all went according to plan, the on-board computer would control the *Eagle's* descension rate. And if it detected boulders, craters, or crevices, the computer would maneuver the lunar excursion module away from danger and to a safe landing.

*As the Eagle blindly fell . . . Colonel Aldrin made a decision which saved the mission.*

But all did not go according to plan. As the *Eagle* descended the radio echoes came faster and faster. The on-board computer kept pace with the intervals between echoes and was able to give the crew a running account of the spacecraft's decrease in altitude. The computer could not, however, keep up with the shapes of the echoes. Before the computer could structure a report on the landscape, it had to compare each echo it received with the electronic echo pictures stored in its memory. If a new echo was input before a match was found for the previous echo, no output resulted.

During the final 2 minutes of the *Eagle's* descent, the crew received no computer information about the lunar surface.

As the *Eagle* blindly fell toward an unknown impact point on the basaltic regolith of Mare Tranquillitatis (Sea of Tranquility), Colonel Edwin E. Aldrin, Jr. made a decision which saved the mission. He overrode the on-board computer and took personal control of the *Eagle*.

Seeing what the computer could not and analyzing what it had no time to, Colonel Aldrin maneuvered the *Eagle* to a landing site safer than that chosen by the computer. Though he consumed 1½ minutes of the *Eagle's* 2-minute fuel supply, it was a good thing he did. The computer was dropping the *Eagle* into a field strewn

with boulders 8-10 feet in diameter. "Eagle, we copy you down," came a voice from earth.

"Houston, Tranquility Base here. The *Eagle* has landed."

There was no such exchange between *Luna 15* and earth. Once the space probe achieved lunar orbit, the last effective signal it could receive was to begin its descent. If its on-board computer decided that a course correction was necessary, it would take a signal almost 2 seconds to travel from *Luna 15* to the earth. Even if the decision from earth was instantaneous, it would take almost another 2 seconds for that decision to take effect. For this reason the success of the landing rested solely on the intelligence built into the spacecraft by its manufacturers.

That was not enough. Unlike the *Eagle*, *Luna 15* had no greater source of insight and intelligence indwelling it to take control and to land it safely. The *Luna 15* followed a way that seemed right to the computer

guiding it, but the end result was total destruction.

Consider this spiritual analogy: The Bible says, "There is a way that seems right to a man, but in the end it leads to death" (Proverbs 14:12, NIV). Without the Spirit of Christ, you have only the intelligence with which you were born, only the wisdom you have gained from experience, and only the learning you have acquired from school. As long as you live in the world and are controlled by it, you *think* you are on course. In fact, without Christ you are falling blindly toward an unknown impact point in eternity.

Give control of your life to the One who can see what you cannot and who can guide you in ways you cannot discern. With Christ in the command seat, you will have no need to worry when you face fear, danger, or an uncertain future. Through Christ you will reach the ultimate Tranquility Base. 

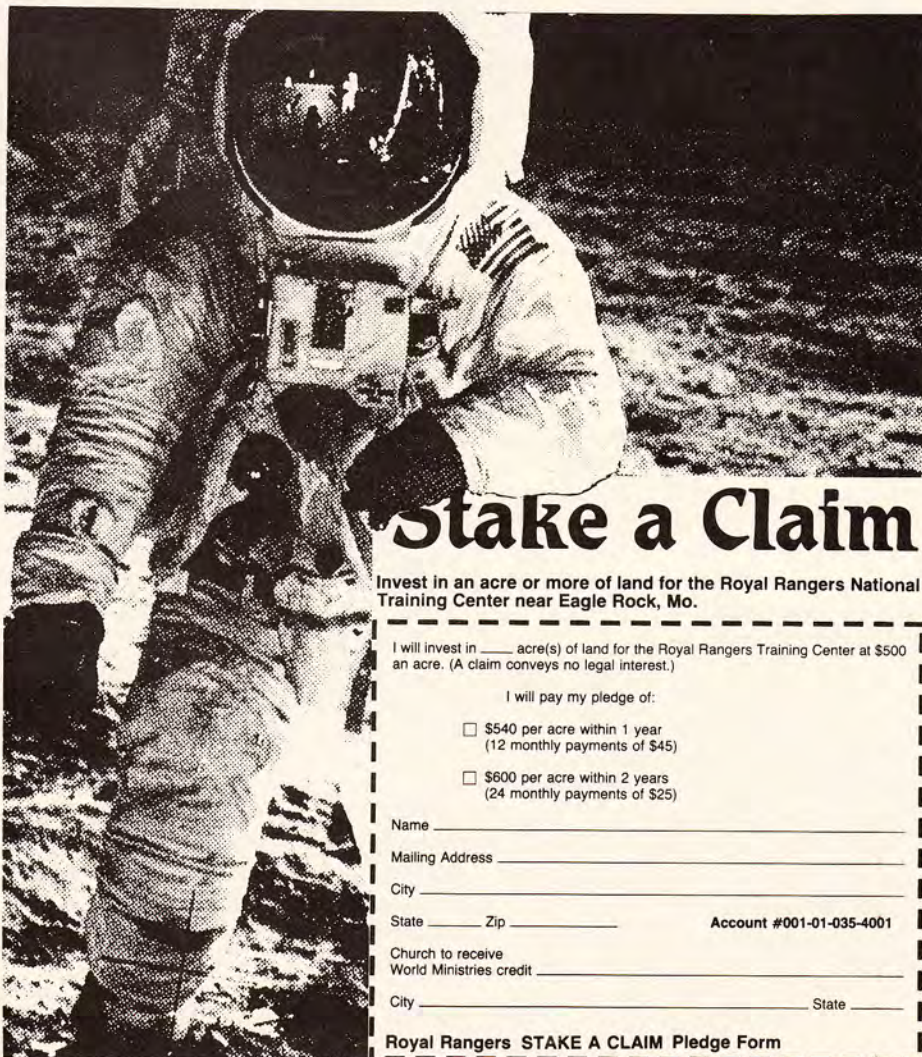

## Stake a Claim

Invest in an acre or more of land for the Royal Rangers National Training Center near Eagle Rock, Mo.

I will invest in \_\_\_\_\_ acre(s) of land for the Royal Rangers Training Center at \$500 an acre. (A claim conveys no legal interest.)

I will pay my pledge of:

\$540 per acre within 1 year  
(12 monthly payments of \$45)

\$600 per acre within 2 years  
(24 monthly payments of \$25)

Name \_\_\_\_\_

Mailing Address \_\_\_\_\_

City \_\_\_\_\_

State \_\_\_\_\_ Zip \_\_\_\_\_ Account #001-01-035-4001

Church to receive World Ministries credit \_\_\_\_\_

City \_\_\_\_\_ State \_\_\_\_\_

Royal Rangers STAKE A CLAIM Pledge Form

Photo by NASA



# Making an Airplane Windmill

By Paul Kittleman

**W**ith a little imagination, you and your Royal Rangers can have lots of fun with soda cans and a little clothes hanger wire. Use my homemade pattern and enjoy, as I do, making airplane windmills. From this simple pattern you can later make several revisions that will fill your outpost with a variety of airplane models.

Follow all safety precautions when teaching your Royal Rangers how to make their own airplanes. Sharp objects are required to construct the model. Cut up soda cans may be sharp as well. This craft requires adult supervision.

## Items Needed:

10 soda cans  
20-gauge picture hanger wire or  
3/32-inch welding rod  
Masking tape, 1/2 inch  
Fishing swivel  
1 small washer  
1 tube airplane glue  
1 pair old scissors  
Felt-tip pen  
Ice pick or nail  
Knife  
Pliers  
Wire cutters

To begin, cut off tops and bottoms of five cans. Straighten them; lay patterns marked "Wheel Strut," "Stabilizer," "Rudder," and "Wings" on flattened metal; and outline the pattern with a felt-tip pen. Make a duplicate pattern with "Wheel Strut" pattern, and make three other duplicates of "Wing" pattern. Now cut out each marked pattern.

Fold together Wheel Strut at dotted line, then fold together protruding tabs around the previous fold. Repeat instructions for second Wheel Strut. Take Rudder and perform the same folding instructions as Wheel Strut.

Now take Stabilizer and punch a hole where indicated. Next, fold over tabs as shown on pattern.

Make loose fold on Wing tabs, later to be crimped around clothes hanger wire or 3/32-inch welding rod.

Using clothes hangers or welding

rod, cut four 16-inch pieces, one 9-inch piece, two 6-inch pieces, and one 3 1/4-inch piece.

Take Pattern 1 and tape together edges marked "Bottom Center" and "Of Can." Place Pattern 1 over a soda can—"Portion A" at top of can. Punch holes in center of each marked "X."

Next, use edge of Pattern 1 to make a guideline mark around top of can (about 1/8 inch from bottom) for cutting off bottom of can. With an old pair of scissors, cut off bottom of can. Now punch a hole in center of can at bottom. This can will now be considered "Can A."

Next, take another can and make a propeller. Punch a hole in the can's center. Using Pattern 1, mark an edge around the same can 2 3/4 inches from bottom. Cut can around marked line. Now place Pattern 1 over bottom portion of can—"Portion B" of pattern along cut edge. With scissors cut vertical lines on Portion B of pattern where marked. Fold back cut portions of can at 90-degree angle to form the plane's propellers.

Now take another can (now called "Can B") and punch a hole in center of can at top—next to removed tab. Punch two holes 1/16 inch from bottom of Can B—one at top, one at bottom. Take a 6-inch piece of wire and bend one end (about 3/16 inch from end), forming a hook. Thread the curved end through the hole you've punched at top of can.

Now take Can B and insert it onto Can A—open end covering top of can B. The wire protruding from Can B will thread through center hole of Can A. Cover wire, now protruding through Can A, with ample tape to avoid injury during construction and to prevent wire from slipping through hole. Punch holes in Can B in same location as holes at top of Can A.

Next, take two pieces of 16-inch wire and thread through four holes in either side of Can A. (This will be the top of the plane.) Place cut-out Wing pattern onto top wires of either side. Crimp the folded Wing edges onto the wire. Repeat instructions for opposite side.

Take two more 16-inch wires and thread through remaining four holes

in can. Place metal Wing pattern onto the wires of either side. Again, secure the folded Wing edges around the wire. Punch small holes 1/16 inch from each end of Wings—holes will be 1/16 inch from end and 1/16 inch from edge.

Cut four 1 5/16-inch pieces of can into strips about 3/16 wide. Roll up the strips widthwise, leaving enough room to thread picture hanger wire through each. Place these wing supports between and at the end of each Wing where holes are.

Beginning at the bottom wing on one edge of the wings, thread picture hanger wire through holes and wing supports until you have completed a circular pattern. (The picture hanger wire will cross the tops and bottoms of the wings.) Now cut the wire, leaving enough to twist together the wire ends. Repeat instructions on the opposite wing ends.

Before assembling Wheel Struts onto body, thread 3 1/4-inch wire (which will be the axle) through holes of either strut. Use bottle caps, and punch a hole in center of each. These will serve as wheels. Insert wheels onto axle ends. Airplane glue can be used to secure the wheels onto the wire. Several options can be used.

Once the glue dries, secure the assembled Wheel Struts onto the plane's body between bottom Wings. Thread picture hanger wire through top ends of each Wheel Strut—where patterns had been folded over, leaving a small gap. Wrap wire around clothes hanger wire at base of plane where bottom wings are mounted.

Thread picture hanger wire through Wheel Struts again, and wrap the wire around other wing mount, on same side. Repeat instructions for the other Wheel Strut.

Next, place the 6-inch coat hanger wire through the bottom hole in Can B. Take the Stabilizer and put 6-inch wire through Stabilizer's hole. Pointed tip of Stabilizer should be directed toward front of plane. Take Rudder and insert it onto wire protruding through Stabilizer—between gap of fold. Notice the location of the small, unfolded section by the pointed tip of the Rudder. Make an



## RUDDER

incision on top of Can B for this portion of Rudder, and insert Rudder portion into Can B. Glue Rudder and Stabilizer to plane's body.

Without disturbing Rudder and Stabilizer, bend wire protruding from the bottom of Can B into a "J" shape. Bend wire at a 45-degree angle about  $\frac{3}{4}$  inch from base of plane. Make another 45-degree bend about  $\frac{1}{2}$  inch from that bend.

One of the last steps of completing

your project is to assemble the propeller. Remove the tape you earlier placed on the wire protruding from Can A, and place propeller onto Can A (wire going through center hole at base of propeller). Cut off excess wire. Secure the propeller to Can A by gluing end of protruding wire. Several options of securing propeller are available.

Now for the final step. Punch a hole at top and bottom of Can A, centering

the holes between Wings at a point where the plane will balance. Insert the remaining 9-inch wire through top and bottom holes. Place a small washer onto the wire underneath the plane. Bend end of wire 180 degrees to make a closed loop. Place a fishing swivel onto other wire end.

Congratulations! You're finished! Have fun mastering this craft and teaching your boys a skill that can bring them hours of pleasure. 

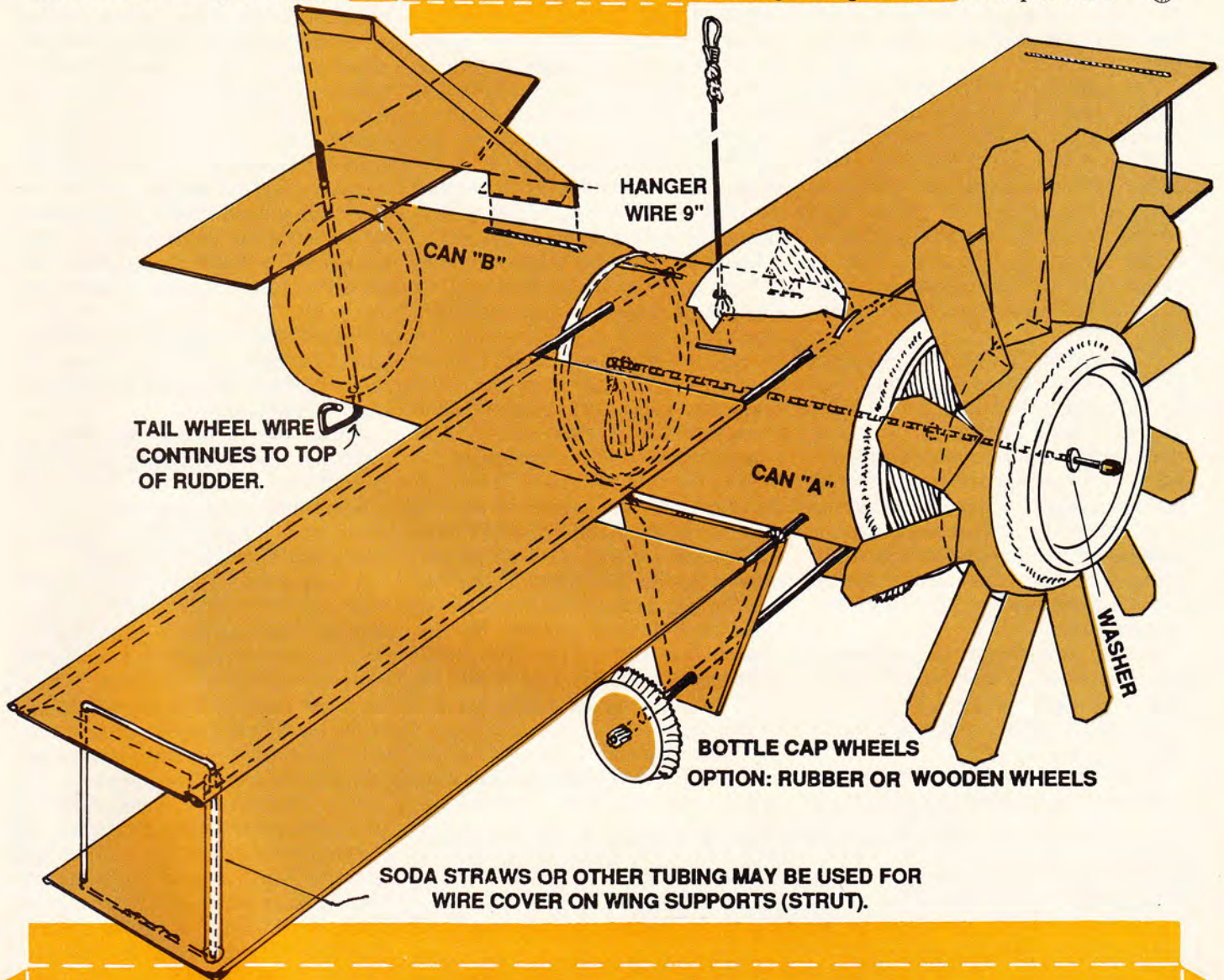

TAIL WHEEL WIRE CONTINUES TO TOP OF RUDDER.

HANGER WIRE 9"

CAN "B"

CAN "A"

WASHER

BOTTLE CAP WHEELS  
OPTION: RUBBER OR WOODEN WHEELS

SODA STRAWS OR OTHER TUBING MAY BE USED FOR WIRE COVER ON WING SUPPORTS (STRUT).

- 4 EA WING WIRES 16"
- 1 HANGER WIRE 9"
- 1 TAIL WHEEL AND RUDDER SUPPORT 6"
- 1 AXLE  $3 \frac{3}{4}$ "
- 1 PROPELLOR SHAFT WIRE 6"

ENCOURAGE CREATIVITY ON THIS PROJECT.  
DESIGN AND SOME ADDITIONS SUCH AS WINDSHIELD ARE OPTIONAL.



# The Thrill of Flying Miniature Aircraft

For boys ages 9 to 99, here's a hobby that invites eager participation: radio control model airplanes. Larry Burns, who has been actively involved in the sport since 1975, says RC airplane flying is a hobby that boys, fathers, and leaders will equally enjoy. A leader, says Larry, can involve his outpost in the year-round sport for as little as \$200.

To begin, Larry urges that you thoroughly learn the hobby first before involving your Royal Rangers. To ascertain more about RC airplanes, either contact a local hobby shop or go to a local magazine vendor that carries literature on RC airplanes. Either source can show you how to purchase kits to assemble an RC plane or how to purchase one that is assembled.

RC airplane magazines such as *RC Modeler*, *Model Airplane News*, and *RC Scale Modeler* list mail order vendors. Ordering through such vendors can save you money. However, you lack the personal advice you may gain by going to a local hobby shop.

RC model airplanes can also be purchased inexpensively from individuals. Search your local classified ads for good buys on RC planes and equipment.

Should you choose to purchase a new RC plane, you have one of three purchase options: total kit, almost ready to fly (ARF), and ready to fly (RTF).

Total kit requires the hobbyist to completely assemble his model. Larry

advises this option for those who enjoy assembling crafts. You will not only appreciate and be proud of your finished product, but you will also better understand the aircraft itself. Assembling your first kit could require as many as 300 hours—this will vary according to each person's skill, speed, and kit.

The ARF kit is mostly constructed. Only three steps are necessary to assemble an ARF model. First, install the radio receiver, servos, and battery pack—which are controlled by the radio transmitter. Second, glue together the wing halves. Third, install the engine. According to Larry, this kit will cost \$110-\$275.

The RTF plane is fully assembled and ready to fly. This option may be appealing to those who do not have time to assemble an RC plane or who do not enjoy doing so. The RTF plane is more costly, however. An RTF plane, says Larry, will cost about \$300 or higher.

But what is the least-expensive investment you can make? Through classified ads you should be able to purchase an RC plane kit for \$15-\$20.

Likewise, an engine to power the plane may be purchased for about \$20. Such an engine would be an .049 cubic inch engine—which has no throttle control. Larger, more-efficient engines can be purchased for \$75-\$100 new and are recommended for the beginner.

A two-channel radio—with receiver and servos (motorized motion output devices that control the

plane's direction)—can be bought for as little as \$50.

According to Larry, the new hobbyist should buy an RC plane with a "tricycle" landing gear, as opposed to a "tail dragger" model. A good gust of wind against an RC plane during take off can cause the tail dragger model to ground loop (go in circles) or to weather vane (veer off course).

Larry also advises the beginner to start with an RC plane that is designed with high wings or shoulder wings. The position on which the wings are mounted to the plane's fuselage are high, shoulder, mid, or low. The high- and shoulder-wing models are usually more stable while in flight. Therefore, the beginner would be less prone to crash his plane when learning to fly.

Regardless of what you purchase, Larry strongly advises aspiring RC pilots to find an experienced, competent instructor.

"There are plenty of qualified instructors who are willing to donate their time to ensure that others are able to safely enjoy their new hobby," says Larry. "They realize what it was like when they were learning."

An experienced RC flyer is needed to occasionally check your workmanship as you assemble your model. And once you've finished, you should take several hours of flying lessons from an instructor before soloing. Your hard work and money can quickly be wasted if the plane is not properly assembled or flown.

According to Larry, one should take all precautions when flying an RC plane. It is not a toy, but a miniature aircraft! Pilots should make certain they fly their RC planes in areas clear of obstacles and away from onlookers. Liability insurance can, and should, be purchased for a minimal cost for both individuals and groups, says Larry. Check with the Academy of Model Aeronautics (AMA) for further details.

If all safety rules are considered, you can provide your Royal Rangers with multiplied hours of fun. The sport would be very fitting for Air Rangers. And most any boy will be thrilled to watch the seemingly boundless RC plane in flight as it pierces the air. 



Larry flying his Sweet Sick RC plane



# LAUGHS FOR LEADERS

Seat belts are nothing new. Grandpa had one hanging next to his bathroom sink.

\*\*\*

These days it's hard to tell whether a pedestrian is walking to reduce . . . or reduced to walking.

"You mean all we're having for supper is cheese?" the newlywed husband asked his wife.

"Well," she replied, "you see, when the chops caught on fire and fell into the dessert, I had to put them out with the soup."

Martha Beckman  
Granada Hills, California

"All right, you dummies, fall out!" barked the drill sergeant.

With much confusion and clatter, every man in the platoon except one scattered. The sergeant glared at the remaining recruit and said, "Well?"

The rookie soldier smiled and replied, "There sure were a lot of them, weren't there, Sarge!"

\*\*\*

"I gave my wife two gifts for her birthday," one neighbor said to another.

"That was generous," the other man replied. "What did you buy her?"

"She said she wanted something to drive, so I gave her a hammer and a nail."

\*\*\*

A meat counter clerk, who had had a particularly good day, proudly flipped his last chicken onto the scale and weighed it. "This will be \$2.70," he told his customer.

"That's really a little too small," replied the customer. "Do you have anything larger?"

Hesitating, the clerk quickly thought, then returned the chicken to the refrigerator. After a brief pause he

took it out again. Once again the clerk weighed the chicken and said faintly, "This one will be \$3.35."

The customer thought for a moment then said, "I know! I'll take both of them."



Said one commander to his pastor, "Since I bought my new car, I don't have to walk to the bank to make my regular deposits."

"Now you drive over?" responded the minister.

"No, I no longer make any!"

Thomas LaMance  
Prewitt, New Mexico



"SEE? THIS IS WHAT YOU'RE SUPPOSED TO DO!"

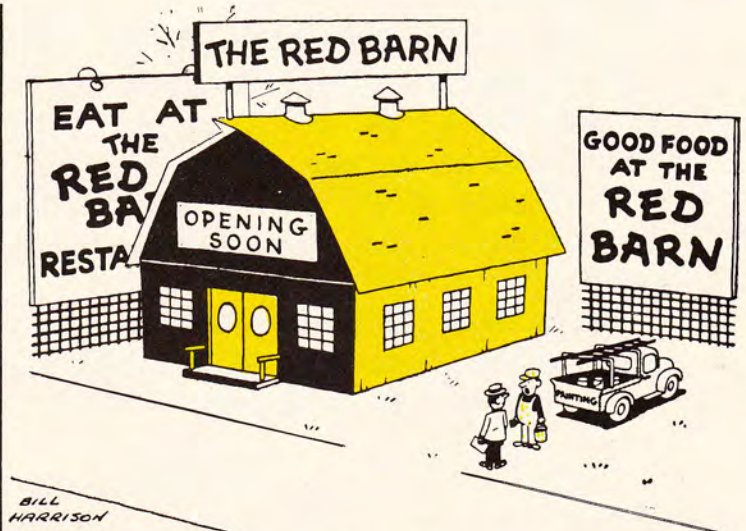

"What color did you have in mind?"





## Support **MISSIONS** today!

Light-for-the-Lost is the foreign missions arm of the Assemblies of God Men's Ministries Department. Laymen raise funds that enable missionaries to distribute tons of Bibles, Scriptures, and gospel literature throughout the world each year.

Last year alone more than \$3 million was given to LFTL. Countless people have given their lives to Jesus because they have read LFTL literature.

More than \$836,000 was directed to Latin America and the Caribbean (where the Royal Rangers ministry is making strong headway) in 1989. LFTL teams will infiltrate 35 target cities in that region within the next year.

Light-for-the-Lost is a missions program every Royal Rangers leader should support; many leaders have already begun. Your help could mean the difference between spiritual life and death for thousands of boys.

Where would you be today if someone hadn't shown you the Light?





Regardless of what he may have thought, Shareef still chased after the costumed Snoopy as he roamed the streets, announcing the Saturday services from the top of an old pickup truck. Shareef was one of our first converts. Today he is Spirit-filled and is busy helping in the ministry here.

During weekly home visits I have been threatened at gunpoint. Recently, I was in the middle of a riot in which four people were stabbed. But mostly, during the past 3 years, the church team and I have had the love and respect of the neighborhood. Even some of the drug dealers allow their children to attend Super Snoopy Sunday school.

Each week our staff and volunteers visit thousands of children at their homes. Food, clothing, diapers, and kerosene are provided where needed.

New Life Church has two 40-foot refrigerated trailers stocked with rice, chicken, peanut butter, and jellies to feed needy families.

It is common to find children alone in the homes, with no idea when their parents—usually the mother—will be back. The children may not have eaten for a day or more. Frightened little ones jump with joy and excitement when Snoopy workers come to their doors.

I have used a 12-minute video, with graphic pictures of the neighborhood, to show the difficult circumstances surrounding children of North Philadelphia. Congregations are beginning to catch a vision for their own communities from the view of our home missions work in North Philadelphia.

"When I saw the outreach territory, my eyes were opened to poverty I never thought could exist in the United States," said one pastor from Rhode Island who had come to visit our ministry.

People from that Rhode Island church have sent money, buses, and volunteers to Philadelphia. For holidays and summer breaks, individuals from the church have even adopted a few of the children.

"I was shocked to see the similarity of North Philadelphia to the slums of El Salvador—people living in run-down houses with no running water," said the Rhode Island pastor.

Another pastor from Texas sent a team of 20 to this inner-city mission field. He said: "This area reminds me of Africa. People do what they have to do to survive. It's rough, but Pastor McCreary knows what he is up against; and spiritual warfare is being carried forward."

The children receive approximately 2 ½ hours of spiritual training each Saturday. Our services consist of praise and worship, Bible memory work, and a short skit, illustrating Bible principles and stories from the Word of God.

My wife Michele and I join talents in producing the skits. We dramatize present-day situations, as well as Bible stories, to enable the children to relate Bible principles to their own lives. The budget keeps things simple, but it does not require much to get the kids excited about Jesus.

We have more influence on those 3- to 12-year-olds than crack and cocaine. Kids need influence, and they need role models. We show the end

results of drugs. In one scene the drug dealer may be high and mighty, but in the next scene he is shown with AIDS. He may even be dying in the scene. We take the glamour away.

Johanna Medina, an orphan whose mother and a 3-year-old brother died of AIDS and whose father killed himself, said: "I love to come to Snoopy because people care about me there. It is the only place I can go that I'm not surrounded by fighting or cursing. At Snoopy Saturday school I can find peace."

We are grateful to the Lord for the results we are seeing in the lives of the children we have touched for Christ. Young lives are being changed.

During early morning prayer we find ourselves in a spiritual battle against Satan for the souls of kids here. But we are seeing great results; many are coming to Christ.

We face an enormous mission field and are touching just a small part of it. With more buses and more people we believe we could, with God's help, turn the city of Philadelphia for Jesus. And New Life Church, with its Super Snoopy Saturday Sunday school outreach, is the beginning.

Please pray for us!



## Facts about North Philadelphia

*Total population:* 113,693

*Population of blacks:* 67,197 (59.1% of population)

*Population of Hispanics and other nationalities:* 17,937 (15.78% of population)

*Population of whites:* 28,559 (25.12% of population)

*Number of young people 19 years old or younger:* 43,059 (37.9%)

*Number of households:* 36,651

*Number of households with female head:* 11,600 (31.65%)

*Average annual income:* \$10,646

*Total number of people living in poverty:* 40,542



# Emergency Flight



Scott grabbed the controls and frantically struggled to gain command of the plane.

By Calvin S. Pitcher

**T**he four-place plane dropped quickly onto a landing strip, which had been hacked into the jungle-covered New Guinea mountainside. Shuddering as the wheels skidded briefly, the plane stopped at the cliff's edge, startling a nearby flock of chickens.

Seated in the copilot's seat, blond, curly-headed Scott exclaimed, "Neat landing, Dad. A piece of cake."

"Thanks," said his dad, Don Benson, a tall missionary pilot. Looking at the wide grin on his son's face, Don added, "Don't you use this strip 'til there's lots of flying hours behind you."

Scott laughed as he thought: *I'm 16, and I solo soon. Dad thinks I have a good sense of flight. I can't wait 'til I go to the States for flight training.* For now, though, Scott was satisfied to let his father do the landings.

Seconds later a crowd of natives approached the plane, carrying a man on a bamboo stretcher. Leading them was Paul Peterson, a deeply tanned American missionary wearing khaki shorts and a T-shirt.

"Hi, Don," he called out. "You got

here fast."

"Of course, Pete," Don replied. "Your radio message said you had someone with a concussion."

"He's unconscious," said Pete. "A tree fell on him while he was cutting it down."

Don pointed inside the plane and said, "Let's lay him in the back of the plane." The natives carefully placed the unconscious man inside.

"All set, Don," Pete said as he shook Don's hand to say thanks. "Try to hold the cold compress on his head to keep down the swelling. Shouting over the noise of the engine, Pete yelled, "The man's name is Uri."

Don and Scott climbed into the cockpit, then Don taxied the plane to the far end of the airstrip. With a great thrust of the engine, the plane took off right over the cliff's edge.

Once airborne, Scott glanced at their passenger, Uri—a short, rugged young man about Scott's age. Uri was wearing little more than a loin cloth. He was dark-skinned and had thick, matted black hair. His hands were calloused from hard work.

It was a beautiful July day, and Scott

couldn't help humming along with the engine. Out of the corner of his eye, Scott saw a sudden movement behind Don.

Uri had revived in terror and grabbed Don from behind. "Scott, grab the controls, right now!" shouted Don.

Struggling to free himself, Don gasped, "He's scared silly."

With one hand Scott unfastened Don's safety belt. Don managed to spin around and push Uri to the back of the plane. In the struggle, the rudder pedals and steering stick were kicked, putting the plane into a dive.

Scott nearly panicked as the ground looked as though it were coming up to meet them. Breaking into a cold sweat, Scott grabbed the controls and frantically struggled to gain command of the plane.

"Whew!" Scott sighed with relief when the plane finally leveled off. Scared as he was, Scott quickly reported, "We've lost 1,000 feet, but I've got her under control, thank the Lord!"

Still shaking, he glanced back. His



dad had a black eye and a bloody nose. "Wow! he's strong enough," exclaimed Don.

Scott pulled off his belt and put it within Don's reach. "Tie him up with this."

"Thanks!" Don grabbed the belt and tied down Uri to prevent further havoc. "Looks like I'm stuck back here for a while. What's our heading and altitude?"

"It's 83 degrees at 1,800 feet," said Scott.

"Get us back to a course of 93 degrees."

"Okay to change throttle setting to regain altitude?" Scott asked.

"Yes, but ease the throttle ahead slowly."

*Scott muttered to himself, "I'll have to land this plane."*

Given more throttle, the plane lurched and vibrated while the engine seemed too loud. Don quickly responded, "Pull back gently on the stick, watch the rate-of-climb indicator, and ease off when the engine labors."

Uri panicked again. In frustration Uri bit Don's arm. "Ouch! Now I'll really tie you up." After a brief struggle Don reported, "The seat belt is tied around his middle, your belt around his hands, and I'm sitting on his feet. Pass me the first aid kit."

Scott was quietly amused. Here was his usually neat and collected father soaked with perspiration. Don's blackened eye was swelling shut, and blood covered much of his T-shirt and khaki shorts. "He did a job on you, didn't he?" Scott said as he glanced back at Don.

Don, smiling wryly, said nothing. Chuckling at his dad's appearance helped, but Scott was still nervous. His sweaty back was sticking to the red plastic pilot's seat. Trembling again and feeling a knot in his stomach, Scott wondered how long he could keep going.

"We're at 2,500 feet now, Dad."  
"Very good. Just keep it there and watch for the base."

"He seems quiet now," said Scott.

"Do you want to take back the controls?"

"No. I better stay with him. We were lucky last time he came to."

Scott muttered to himself, "I'll have to land this plane." Then he thought, *Wish now I'd tried some landings last week when Dad asked me to. We always talk about the Lord helping us when we're weak and doing all things through Christ who strengthens us. This is one time I'll have to really trust the Lord. I'm too shaky to do this on my own.*

Ahead and below Scott saw the familiar runways with hangars off to one side. Trying to sound confident, Scott called the base. "M2F-672 coming in from the west. Request landing instructions."

The flight control tower sensed something different and answered, "Is this a student flight?"

"Yes, and we're bringing in an injured man."

"You're cleared to land on runway three. Your plane will be met."

Don quietly said to Scott: "The Lord will help you. Depend on Him. You're flying nicely. Keep the rpm's at 1,800 and your speed at 75 miles per hour. Give it full flaps as soon as you're down to 700 feet."

Scott's fear returned as he struggled to make the plane respond. It lurched sharply as the flaps went down. "You're doing fine," Don said. "Okay, now lower the landing gear."

Scott called out the altitude as they descended. Hearing "400 feet" his Dad calmly advised: "Keep the air speed at 75 miles per hour so we don't stall. Begin to pull back gently on the stick when you're above the end of the runway."

"Above the runway at 150 feet," Scott exclaimed.

"Cut the throttle," Don said, taking Scott through the landing procedures. "Hold her steady. Let her drop. When she touches down, pull back on the stick!"

The plane hit the runway and bounced 20 feet into the air. Scott let the plane go down again. It bounced a second time then landed smoothly.

"Yowee!" Scott shouted with all his might. "We made it!"

"Best first landing I've ever seen," exclaimed Don as he swelled with pride.

With a sigh of relief, Scott turned to his dad and said, "The Lord did help me!"

# Poetic Towns

By Margaret Cheasebro

Use each clue to fill in the name of the Bible town.

1. Lazarus of B \_\_\_\_\_ wasn't scared when Jesus raised him from the dead.
2. No one wanted to feel the wrath of Goliath the giant from the town of G \_\_\_\_\_.
3. The widow from N \_\_\_\_\_ had a son who died. Jesus raised her son from the dead, and the widow cried.
4. God told Abraham to pack up and leave his home town of U \_\_\_\_\_ and blessings receive.
5. Paul of T \_\_\_\_\_ went about preaching of Jesus, who can set people free.
6. Saul, Israel's first king, lived in G \_\_\_\_\_, a town in Israel.
7. In B \_\_\_\_\_ Jacob dreamed of a ladder leading into heaven while he slept on the ground.
8. Many had a desire to go to this harbor town called T \_\_\_\_\_.
9. When Joseph looked for his brothers in D \_\_\_\_\_, they sold him to a caravan going toward Goshen.
10. Shepherds went to B \_\_\_\_\_ to worship the new-born King named Jesus.

**ANSWERS:** 1. Bethany 2. Gath 3. Nain 4. Ur 5. Tarsus 6. Gibeath 7. Bethel 8. Tyre 9. Dothan 10. Bethlehem



# How To Make a Rocket Ship

By John and Bonnie Eller

**W**ould you like to be an astronaut? You may be too young to fly a real rocket ship, but you can build your own. Blast off right in your own home or outpost. Each room could represent a different star or planet.

Within a few minutes you can make your own rocket and fly it to the imaginary worlds unknown.

## What You Need:

- 1 paper towel cardboard tube
- Poster paints
- 1 sheet of tracing paper
- Different colors of construction paper
- Scissors
- Tape
- Liquid white glue
- Paint brush
- Pencil

## Here's How:

1. The paper towel cardboard tube will become the fuselage (body) of your rocket.

2. Paint the tube to look like a rocket.

3. Trace patterns A, B, and C from this page.

4. Cut out the tracings, and use them as patterns to cut the same shapes from construction paper. Cut out one shape from pattern A, four shapes from pattern B, and two shapes from pattern C. Use different colored construction paper for each kind of shape. Mark the dotted lines on your cut-out shapes B and C as shown on patterns B and C.

5. All shapes should be cut out of construction paper.

6. The nose cone is shape A. To bend it, keep section X on top as you roll paper so that corner section Y meets corner section Z. Tape together as shown on pattern A.

7. The end of the rocket is made from the four shape Bs. Fold each shape along the dotted line as you see on pattern B.

8. The blasting flames are made from the two shape Cs. Cut slits along the bottom of each shape C, as shown on pattern C.

CUT OUT HATCHES AND WINDOWS, GLUE TO ROCKET BODY AT YOUR OWN DISCRETION.

9. Attach all the rocket parts to the fuselage with glue as follows:

- a. Glue nose cone over top of tube.
- b. Glue the four tails on the bottom, equally spaced.
- c. Glue two flames to bottom of tube.
- d. Paper doors and round windows are optional. They may be cut from this page and glued to rocket.

Now get ready for blast off!

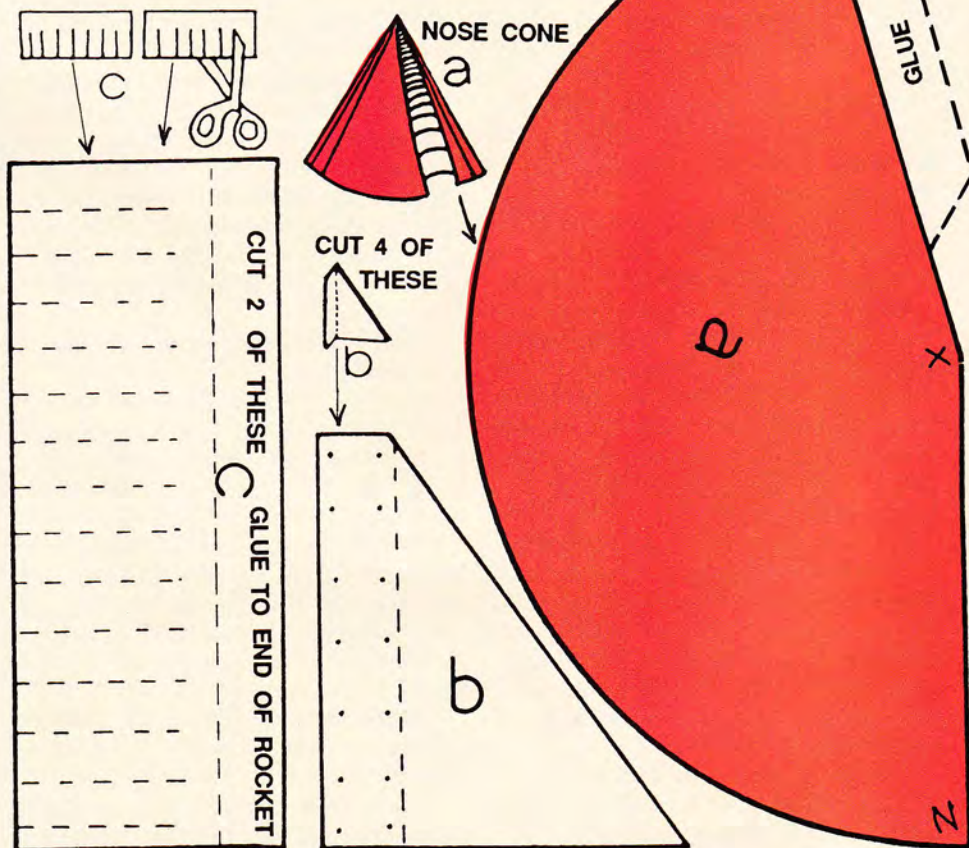
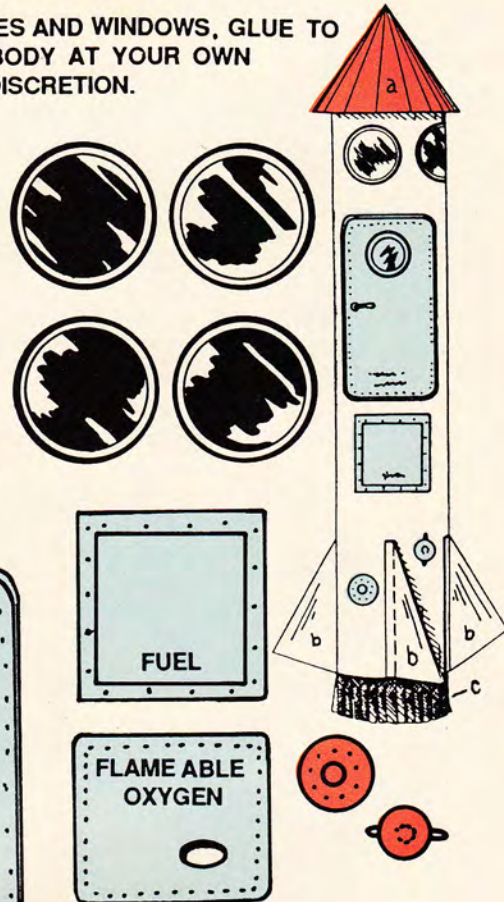
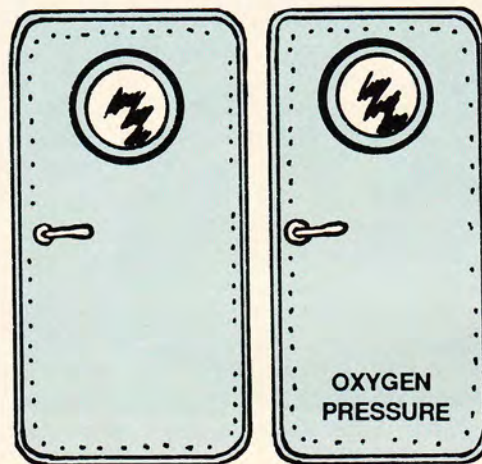



# Dare To Dream

**J**ohn Savage was about 20 years old when he began what now serves as his employment: flying. John is the corporate pilot for the General Council of the Assemblies of God. The ordained minister has served in this position since 1979. John uses his talents for the Lord by flying national church leaders to major functions throughout the United States and to other nations. He has flown more than 28,000 hours since he first piloted a plane.

John always had a spirit of adventure and enjoyed being around airplanes. He began taking flying lessons at age 20 when he was in the Air Force.

At first he was unsure if he could ever master the skill of flying. "I looked at all those instruments and thought, *There's no way I'm going to be able to figure out what everything is suppose to do,*" John said.

John discovered that learning to fly is like learning anything else, however. At first even the most basic steps seem impossible. But within time they become second nature.

John went on to obtain his pilot's license, then later his commercial license and instructor's license.

If you want to be a pilot someday, John suggests you first have a physical to determine if you have any physical disorders—such as color blindness, loss of hearing, or any other problem that could prevent you from becoming a pilot.

According to John, about 25 percent of the approximately 15,000 people who apply for the Air Force Academy each year are turned down because of hearing loss. Many young people today experience hearing loss after having listened to loud music with headphones on for some time.

If you pass the physical, then you can apply for ground school and learn interesting things about flying. Some of the subjects you would study are what makes an airplane fly, how various weather conditions affect the plane while in flight, and the components of an airplane. The average cost for ground school, says John, is about \$150.

Those who pass ground school are qualified to begin flying lessons. During flight school (noncommercial) students will take about 20 hours of flying lessons with an instructor. Students are then required to obtain 20 hours of solo flying time. Each stu-



dent's solo flight is heavily regulated by the flight instructor.

Once a student has completed all the required hours of training and has mastered the skills of flying, he then is eligible to take a flight test to obtain a pilot's license. The student can only do so, however, with the recommendation of his instructor.

Flying, says John, is just like being a Christian. A pilot must always respect his plane and take good care of it. He must always be well equipped. He must always keep updated on the rules and regulations that affect him while in flight. He must always be prepared for storms and other dangers that may come his way.

Likewise, the Christian must respect his body and keep it in tiptop shape. He must respect others around him . . . or he could hurt someone or himself. He must always read his Bible, so he will be well prepared when life's storms come.

What is your attitude in life? Is it a servant's attitude? What are your ambitions in life? Whatever you choose to be, always remember John's advice:

"Give it your best shot, and do it as though you were doing it for the Lord! Motivate yourself. If you have a dream of one day being a pilot or maybe an astronaut, then reach for the stars. Whatever you do, set a goal in life, and keep that goal before you."

## Why an Airplane Flies

*Gravity* is the force that pulls or attracts objects to the earth. Gravity must be overcome before a plane can fly.

*Lift* is the force that overcomes gravity. It is produced by the flow of air over and under the airplane's wings when the plane is moving.

The plane's wings are designed in a special shape called an "airfoil." These airfoils aid in producing lift. Because of the shape of the airfoils, the speed of the air on top of the wing when passing over it is greater than the speed of air thrusting below it. The reason is because the air on top has farther to travel. Consequently, the pressure below the wing is greater than the pressure above. And this pressure from beneath causes the plane to rise. This is a lift.

*Thrust* is the force that carries an airplane forward through the air. Thrust is produced by the force of the propeller and engine or by the jet.

*Drag* is the force that resists thrust or the forward motion of an object through the air. The amount of drag depends greatly upon the shape of the object. That's why planes are shaped the way they are.

When a plane takes off, lift is greater than gravity, and thrust is greater than drag.



# TV: Blessing or Curse?

By Rev. Chuck Goldberg

**M**y 6-year-old son was brushing his teeth, with my wife's help, when suddenly he said, "Mother, there's something I've been wanting to ask you for awhile."

"What is it?" she asked.

"What is. . . ." He proceeded to say the word.

Shocked to reality, my wife questioned, "Why do you ask?"

"Because," he replied, "I've been hearing it so much on TV."

Our children are only allowed to watch public television and Christian programming. We were amazed that our young boy would be exposed to such thoughts.

Studies show the average American home has the TV on 5 to 7 hours a day. So if a kindergartner watches 30 hours a week, by age 16 he will have spent more time before the TV than in school!

Television is clearly a powerful force, impressing us in ways we don't realize. TV makes little effort to protect young minds. Kids today can return from school and watch *Geraldo* exploring subjects they shouldn't be exposed to. Or they can see a heavy metal band on MTV gyrating to words praising drugs and suicide.

Television's worst fault is in giving an untrue view of life. Flip on any channel, and what do you see? Beautiful young women and handsome men, but few elderly and poor.

Except for shows like *Roseanne*, your usual television family is upper or middle-class and living the good life. And violence happens on TV 10 times more than in real life.

Prime time TV contains six to eight violent acts per hour, with two entertaining murders a night. The more violence you see, the more you regard it as okay to solve your problems. And not only kids are affected by TV violence; adults are too!

The simple fact is TV programs often contradict Jesus' teachings. Jesus taught us to love our enemies, to turn the other cheek, and to respond to evil with good. Many TV shows, though, tell us to hate our enemies, to respond to evil with evil, and to take the revenge that fits the wrong.

Thomas Radecki, research director for the National Coalition of Television Violence, said this: "Children learn the values being taught on TV—to hate their enemies, that violence solves problems, that nonviolent resistance doesn't work. . . . TV, even the cartoons, doesn't consider work-

ing for peace or envision our enemies as anything but hopelessly evil."

But is TV totally bad? Should we banish it from our homes? No way! When TV sports began cutting sharply into my time with God, I banished TV from my home and lived just fine without it for 7 years. After I got married, my wife finally convinced me to bring it back. Now TV is no longer a problem because I control it, and it doesn't control me. Together my family and I enjoy some shows, an occasional movie, and the news. But the TV is used mainly to

---

*Studies show the average American home has the TV on 5 to 7 hours a day.*

---

watch Christian programs, which bless my wife during the day and give my kids an alternative to the often-violent Saturday morning cartoons.

Because my 6-year-old son is being exposed to Christian TV shows, he has grown closer to God and has become a little authority on the Book of Revelation.

Clearly, TV can be a great blessing or a terrible curse. It has captured events that will live forever. It has forever changed our culture and the way we view our world.

Careful use of the TV helps inform us, educate us, and inspire us. But if you just plop in front of the set and watch whatever comes on, you are doing yourself no good and are developing a habit that may be hard to break. For example, spending hours watching the bright moving images does nothing for your imagination or creativity. If this is your case, get off the couch and read a book, play a game, or call a friend.

What is TV for you—blessing or curse? It can enrich your life. It all depends on you!





# COMEDY CORNER

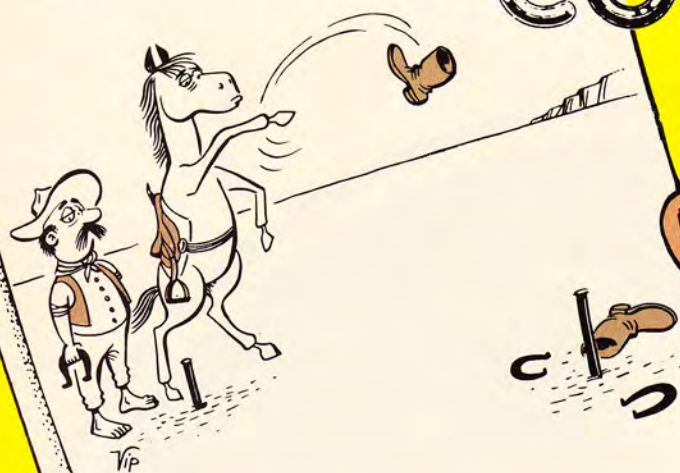

While taking a test, a bright, young man became stumped on the second question. It read: "Give the number of tons of coal shipped out of the United States in any given year."

After a few moments of thought, the boy wrote: "None in the year A.D. 32."

\*\*\*

A stranger entered a church in the middle of the sermon and sat on the back pew. After a while he began to fidget.

Leaning toward the white-haired man beside him, the stranger whispered, "How long has the reverend been preaching?"

"Oh, 30 or 40 years, I think," answered the old man.

"In that case, I'll stay," decided the stranger. "His sermon must be nearly finished."

\*\*\*

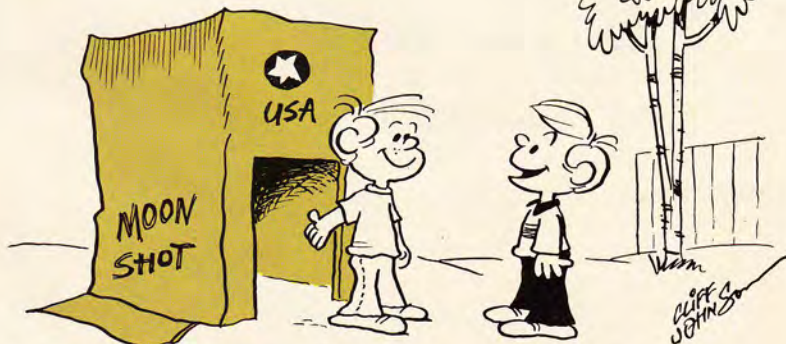

"O.K. I GUESS WE CAN GO TO THE MOON, BUT I'VE GOT TO BE HOME FOR DINNER IN HALF AN HOUR!"

A man finally succeeded in buying a parrot at an auction after some spirited bidding.

"I hope the bird talks," he said to the auctioneer.

"Talk!" responded the auctioneer. "Who do you think's been bidding against you for the last 5 minutes?"

\*\*\*

At the end of the art period, the nursery school teacher went around the classroom to check the drawings of the 4-year-olds.

Pausing before a blank sheet of paper, she inquired, "What is this?"

"A boat," said the young boy.

"But I don't see a boat," said the teacher.

"That's because it just sank!"

Thomas LaMance  
Prewitt, New Mexico

**Question:** What does a frog say when he wants his money back?

**Answer:** Rebate! Rebate!

Sylvia Kreng  
Los Angeles, California

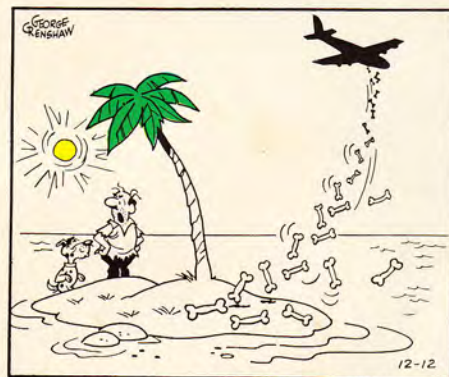

\* JUST WHAT DID YOU WRITE ON THAT NOTE IN THE BOTTLE? \*

**Question:** What did the father buffalo say to his offspring when sending him off to school?

**Answer:** Bison!

\*\*\*

**Question:** Who is the thief they caught by the meat counter?

**Answer:** The hamburgerlar.

\*\*\*

Baby sardine to her mother as a submarine chugged by: "Look, Mom! A can of people!"

Don Miller  
Kensington, Maryland



*Shoot for the stars!*



Earn the highest award available in the Royal Rangers program: The Gold Medal of Achievement.

Begin by setting high standards and goals for yourself by learning the most you can about being a Royal Ranger. Earn the most possible ratings in whatever Royal Rangers program you may be.

If you are an Air-Sea-Trail Ranger, strive to earn the required advanced awards for the Gold Medal of Achievement.

*Talk with you commander today.* He will be glad to support you in your goal of earning the **GOLD MEDAL OF ACHIEVEMENT!**