

Fall 1997

HIGH Adventure

Special Collector Edition



- Featured Prints by Fred Deaver
- Farewell to Major Bummer and much more!

CAMPING

Camping Experience

3

Camping Feature

5

Major Bummer Finale

6

Camping Overseas

8

RON ROBERTS, National Coordinator
HonorBound: Men of Promise

KEN HUNT, National Commander
Director of Publications

MARSHALL BRUNER, Editor-in-chief

CLINT DAVIS, Designer/Managing Editor

JIM ERDMANN, Technical Editor

SHIRLEY SPEER, Technical Editor

BEVERLY DELPORT, Editing Assistant

Camporama

10

Rascal Rangers

12

Comedy & Activity

14

HIGH ADVENTURE—Volume 27, Number 2 ISSN (0190-3802) published quarterly by Royal Rangers; 1445 Boonville Avenue; Springfield MO 65802-1894. Subscription rates: (*High Adventure Leader* only) single subscription \$9.95 a year; bundle (minimum of five subscriptions, all mailed to one address) \$9.00 a year, \$13.95 (foreign mailing address).

© 1997 General Council of the Assemblies of God, Inc., Gospel Publishing House. Printed in USA. Periodicals postage paid at Springfield, Mo. POSTMASTER: Send address changes to *High Adventure*; 1445 Boonville; Springfield, MO 65802-1894.

EXPEDITION

A Day in the Life of a Royal Ranger



by Dana Lemieux



he bus for the overnight camp-out leaves at 7:00 a.m., and I overslept. It's now 6:45 a.m. I quickly grab my things and fly out the door. My mom stops for all the yellow lights, she just doesn't know how to drive fast. I hope we make it in time.

It's 7:05 a.m. and the church is still 5 minutes away. I hope they haven't left. Finally, we pull into the parking lot. They were just about to leave. I quickly jump onto the bus and we're off, but I have to go to the bathroom.

Two hours later we are there and I find a rest room. Now my stomach begins to growl, so I grab some food from my pack. Five steps up the trail my shoe comes untied, so I stop to tie it and the lace breaks. Good thing the commander has a spare.

After hiking for an hour, I grab my canteen for a quick drink, and realize I forgot to wash it out from the trip 3 months ago—the soda is just a tad moldy. So I borrowed some water from the commander and grab some more food from my pack. I should have had breakfast.

After another mile my feet start to hurt. As I stop to take care of the problem, I notice I'm wearing a pair of socks with holes. It's

a good thing the commander had some moleskin I could borrow. After lunch we start to rock hop across the stream—I fell in. I think my sleeping bag got wet 'cause my pack really feels heavy now.

We stopped for another break and I realized I still hadn't cleaned out my canteen. I borrowed some more water from the commander. It's almost supper time; boy, am I starved. I can't find my matches to light my stove, so I borrow some from my commander. I end up using all the matches and still can't get the stove to light. No wonder, it's out of fuel. I wonder where the commander is. Finally, I get the stove going. Now I need some water to cook with, so I head down to the stream. I fell in again, cleaning out my water bottle. Back at the camp I pull out my pot and it's dirty. I trudge back to the stream and clean out the pot, but I didn't fall in this time. Back at camp the stove is starting to sputter. I shouldn't have left the stove going. I'll just borrow some more fuel and a few matches from the commander. Finally the water is hot, but I can't find the supper items. I think I ate them for breakfast. I wonder if the commander has any extra food.

It's getting dark, and I finally find my flashlight. It had gotten turned on in my pack and now the batteries are dead. It's getting

close to bedtime and I forgot to dry out my sleeping bag. The commander always has some extra warm clothes. I'll just go find him.

It's really dark now and I have to go to the bathroom. Out in the woods I stub my toe on a root and bang my head on a branch. It's too bad the commander had already loaned out his flashlight and spare batteries. Then I get sprayed by a skunk. Well, at least my mom won't be to mad, 'cause most of the clothes I'm wearing are the commander's. I can't find the tent, and when I finally do I get kicked out. Well, I'll sleep under the stars; it doesn't look like rain.

I wake up damp from the dew, and ready to have another exciting day. I wish we did this more often. Hmm, it looks like a mouse ate my breakfast....

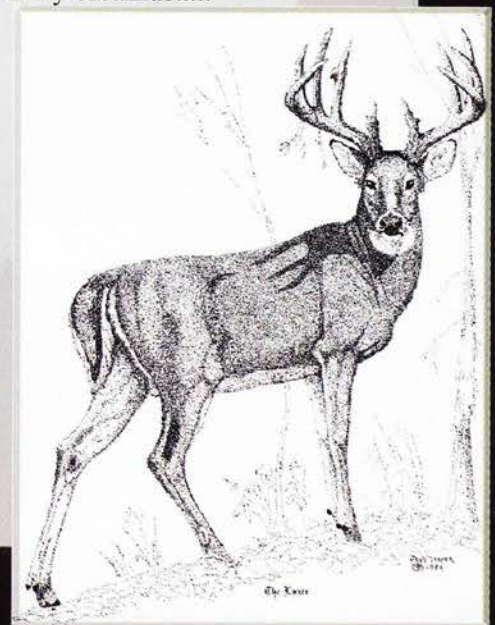

A Weekend at Camp Eagleheart

Camping Feature

by Jim Barger



Commander Jim, I've got cabin fever, and we're overdue for an outpost camp-out," Senior Guide Brad exclaimed at the gold bar meeting. "It's time to get out for a weekend and work on requirements and throw in a good dose of fun. Pow Wows are neat and snow days are the greatest, but I just want our outpost to be alone for a change."

"Well, guys, pick the weekend and we'll go to Camp Eagleheart. It's close enough that we can stay over Saturday night and still have time to break camp and be back on time for church," Commander Jim responded. "We'll have each person bring and prepare his own food and pass all the fire-craft and cooking requirements. Let's check with the patrols at the outpost meeting Wednesday night and see what they want to do for the 'fun things.'"

"CAPTURE THE FLAG," rang out so loud that the rafters in the Rangers clubhouse shook as the boys responded in unison. Lack of excitement was

not a problem as we chose our time and made the plans. Gear was checked over and a couple of repairs were made by some of the guys who were so "ready" to go camping, they gave up their recreation time. After the meeting, the commanders and guides made lists of responsibilities and items to be brought along.

Camp time came, and supper time Friday found the campsite in pretty good shape by the time the cooking fires were lit. Levi brought hot dogs, Jarod had good—old beef stew, and Jeremy had spaghetti. Commander Greg brought steak and proclaimed loudly to all the virtues of the gourmet meal he would soon be savoring.

He put one in the old skillet with the wood handle that he's so proud of and held it over the coals. All of a sudden, PLOP into the fire went the steak as the skillet pivoted inside the hollow wood handle. "Hey, Levi, can I have a couple of hot dogs?" Greg called.

"Sure, but what

happened to your steak?"

"It's in the fire!"

Bringing over the hot dogs, Levi speared the steak with his hot dog stick, sloshed it in a pan of water, and carried it to his cooking fire. "Great steak, Commander Greg," he called out 15 minutes later with a satisfied, sheepish grin.

Evening devotions evoked a discussion that went far into the night and covered everything that is perplexing to a young man in this day and age. Commanders shared suggestions and assurances from God's Word as one question after another popped up. As boys drifted away from the warmth of the campfire and nestled into their sleeping bags, they took comfort that Christ was truly their answer for any situation.



Breakfast found Commander Al with his very favorite camp food, a box of doughnuts. Levi partook of hot dogs as the Pioneers struggled with burning bacon and eggs that were determined to stick to the bottom of the pan. Commander Kent used this teachable moment to demonstrate how a little cooking oil in the skillet would make the task much easier.

After flag-raising and the thought for the day, shared by Commander Bob, the patrols were assigned their team color for "Capture the Flag." The rules were detailed until every question was answered. Boundaries were laid out and the "protectors" set off to secure their flag. After 5 minutes or so, the "captors" began their searches.

First Andrew, then Caleb, and then a steady stream of Rangers appeared at the base to have their "lives" renewed. All of a sudden, way off in the far corner of the woods, cries of pain and agony arose, reaching all the way to the base.

"Those Trailblazers are playing too rough and now some one has gotten hurt badly," Commander Ron said as two other commanders dashed off.

"Yellow jackets, yellow jackets, run, run!" was being shouted by three boys on a dead run, heading for any place except where they were at the moment. The commanders turned and

ran with them, reaching base completely out of breath.

As the story unfolded, one of the boys had just spotted the blue flag when he was ambushed by two defenders who were trying to get his gauze armband. One of them stepped on a rotted log and out poured the yellow jackets. Damage assessment revealed that the three had only a total of five stings, and first aid quickly relieved the pain as they settled in for a rest period.

"I got it! I got it!" Commander Steve shouted as he chased the long pass that Donny had thrown during free time after lunch. "RIP" went the tent as Commander Steve plunged completely through the side, tearing it from top to bottom.

"We can get it fixed," he said looking at the red spot on his shin where he had scraped it on the cot inside.

"But guess who gets to look at the stars tonight?" asked Jimmy as he replaced his cot with Commander Steve's.

Everybody pitched something into the kettle to make up some "don't ask" stew, which gets its name from the answer given as a recruit looks into the

stew pot and says, "Ugh, what's in here?" Of course, Levi threw in lots of hot dogs.

The Trail Rangers had worked hard in the afternoon to put together an impressive council fire complete with a "magic" fire starter that mystified all the others. Stunts and skits that had been worked up in the afternoon made everyone laugh. Funny songs with lots of silly motions got the boys in a receptive mood.

As the flames began to settle down, Pastor Dutch was invited to share a devotion. Using the object lesson of the yellow jackets' stings, he shared from First Corinthians 15:55: "Where, O death is your victory? Where, O death, is your sting?" (NIV). He told of the victory that Jesus won over the sting of death and invited those that had never asked Him into their lives to do so, and for those who wanted to rededicate themselves to Him. Two names were written in the Lamb's Book of Life.

"Commander Jim, results like this can only happen on outpost camp-outs," Brad said as they drove into Sunday school the next day. "Just think, everybody passed lots of requirements, and we had a ball. I got some good advice on a tough situation and there are two new Christians in our outpost. One thing though, don't sit next to Levi; he smells like a hot dog."



The Final Major Bummer



by Robb Hawks

“What happened?” Shelton whispered.

“I’m not sure,” Chris replied, “but they say it was really bad.”

“Okay, boys, you can see him now. But you can stay only a few minutes. And try not to get him too excited. He is still in critical condition,” the nurse whispered as she led the boys down the sparkling-white hospital halls and into the Intensive Care Unit.

The boys were amazed at all the fancy machines, blinking lights, and soft beeping sounds. The nurse stopped then pointed to room 301. Shelton and Chris entered the room to find their Royal Rangers commander already there.

“Hi, Commander. How’s Jonathan doing?” Shelton asked.

Jonathan was laying still. His head was bandaged. All kinds of machines were

hooked up to him. One machine hummed and another beeped softly.

“Is ... is he dead?” Chris asked.

“No, but he’s really bad,” the commander noted. “God spared his life last night, though.”

“What happened?” Shelton asked again.

“Jonathan was riding home from Rangers last night with his mother, when a drunken driver crossed over into the other lane and hit their car,” the commander said. “Jonathan’s side of the car was hit hard and he was hurt bad. Fortunately his mother walked away from the accident with only minor injuries.”

“Wow,” Shelton exclaimed.

The two boys and their commander offered a prayer for Jonathan’s speedy recovery then left.

Darby and Ryan Jones

passed the Rangers and commander as they walked toward Jonathan’s room. Darby paused at the door and swallowed hard. He could not believe what he had done last night. He and a few of his old college buddies had gone to a bar and had gotten drunk.

Darby could barely remember the dizzy ride home and then the accident—one he had caused and one that almost killed a teenage boy named Jonathan. Darby took a deep breath and stepped into the room. His 9-year-old son Ryan followed him. Darby and Ryan stared at Jonathan. Poor Jonathan really looked pitiful.

Darby looked down at his own son. Suddenly the reality of what he had done struck him with full force. How would he feel if his own son were in that hospital bed? What if someone else had gotten drunk and hit his car? What if that drunken person had caused his precious boy to be near death?

Darby was a tough man. He had played football in college. He had even spent time in Vietnam as a soldier. But this was something tougher than Darby had ever experienced. He sat down in a chair, placed his head in his hands, and began to cry.

Ryan looked at his father

in surprise. He had never seen his father cry. Ryan was not sure what had happened last night. He knew, though, that his father had been arrested by the police and that his red pickup truck had been totaled in an accident. Now they had come to visit this teenager in the hospital.

"I'm sorry," Darby cried. "I'm so sorry."

Suddenly Jonathan stirred in his bed. He slowly rolled his head toward Darby and opened his eyes. "Hi," Jonathan whispered with a moan.

Darby looked up in shock. He wiped the tears from his eyes then looked at Jonathan. "It's all my fault, Jonathan," Darby began. "I'm so sorry. I never should have gotten drunk last night. I never should have gotten in my truck and tried to drive home. I'm so sorry."

"I guess you did cause a big mess of things," Jonathan said, whispering with half an attempt at a grin.

"I ... I don't expect you to forgive me, but I want you to know that I'm sorry,"

Darby said, trying to apologize.

"Don't worry about it,"

Jonathan said. "I forgive you. But I'm not the one who really needs to forgive you."

"If not you, then who?" Darby asked puzzled.

"You should ask God to forgive you, that's who," Jonathan replied.

"Why should God forgive me? I don't deserve it. I don't deserve anything good."

"Join the club," Jonathan added. "No one deserves God's forgiveness. God chooses to forgive us because He loves us."

"God would forgive me?" Darby asked. "How?"

"It's easy. Just ask Jesus, God's Son, to forgive you and to come into your life. And you know what? He will!"

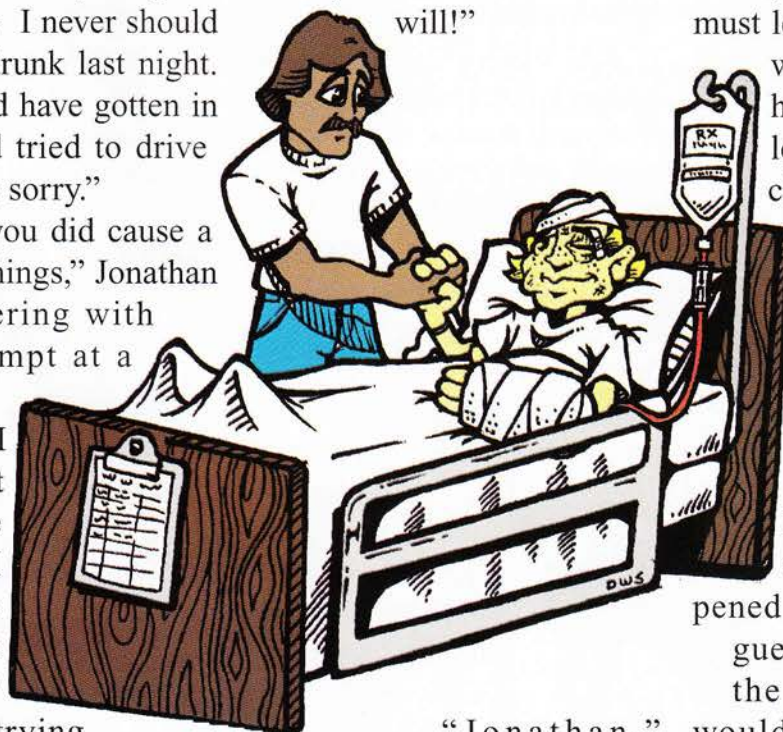

"Jonathan," Darby said with a sense of hope, "I never really believed

in God. But I can see in you a love that can only come from God. I almost killed you because of my drunk driving. Yet here you are telling me that not only you can forgive me ... but that God can too. I think I would like to ask God to forgive me."

"Then just say this prayer with me," Jonathan said. Darby bowed head and prayed along with Jonathan. "Dear Jesus, I'm sorry for my sins. Please forgive me. Please come into my heart and be the Lord of my life. And I promise to live for You forever. Thanks."

Jonathan and Darby talked for a few minutes, then the nurse came and told Darby and Ryan that they must leave. Darby and Ryan walked back down the hall toward the parking lot. Ryan noticed a real change in his father.

Darby had walked into Jonathan's room sad and full of remorse. But now Darby was walking along light-hearted and even happy.

Ryan was not sure exactly what had happened to his father, but he guessed that life around the Darby Jones home would never be the same again.

CAMPING WITH A PURPOSE

Camping Overseas

BY PAUL ETHERIDGE



Do you love to camp—to get away from civilization and to be self-sufficient? Wouldn't it be great if we could go camping and find a way to help others at the same time and use our camp-craft skills to help people who cannot help themselves?

In Royal Rangers there is a way to get away from it all, to get back to nature, and to use your camp-craft skills as a part-time foreign missionary. It is called Pathfinder Missions, and it is for Royal Rangers leaders who are members of the Frontiersmen Camping Fellowship.

I should warn you, Pathfinder trips are a lot of hard work. We build structures on mission fields like

churches, schools, bridges, and anything else needed to further the gospel. We only go into places other groups do not want to go—places like jungles, deserts, high altitude mountains, and places where there are no modern conveniences. This means we have to camp, cook our food, purify our water, and, in general, provide for ourselves. As you might imagine, this leads to some interesting camping.

Let me share with you some of our camping experiences. We were in the high desert of Central Mexico, building a church for a village of goat herders. As they prepared a meal for us, we watched as they slit the goat's throat, skinned him out, and cooked a meal without wasting a single part. Most if it was good, but the goat guts stuffed with fat and then fried were a little hard to swallow. They had a big pot boiling with all of the goat pieces and parts.

After it was cooked, everyone just reached in and grabbed a handful of pieces. We had no idea what we were eating, and it was probably just as well that we didn't.

Another interesting meal was in the jungles of Chiapas. We had to dig a latrine the first day. Every day after that, a certain pig would root in our latrine. The last day in the village there was a special feast prepared for the team. Guess what animal was killed for our dinner? You guessed it: that certain pig!

Our campsites have been unique experiences. We were building a church for the Wastiko Indians in Mexico. The terrain was mountainous and steep. Rock slides were frequent. To provide a site for their thatched huts, the Indians would cut a notch out of the side of the mountain and build on the small flat ledge. When we arrived, we had to squeeze a tent alongside a hut. Our team was spread out all along the mountainside.

In Chiapas, we camped in a clearing beside the church



HIGH Adventure

LEADER



Ken Hunt, National Commander

Australia Adventure

2

OnLine

4

Rangers in Malaysia

8

Craft

10

Michigan Pathfinder

12

Devotions for Boys

14

One-On-One *Memories for a Lifetime* by Ken Hunt

I grew up in central Missouri, living on a farm. Unlike many of my schoolmates, chores consisted not in cleaning my room or washing dishes but in outdoors work. And lots of it! As a youngster, life in reality became an outdoor adventure.

At 6 a.m., milking the cows! Now that's adventure, especially after Dad's rebuking to me and my brothers for milk-squirting fights. Unless you've experienced it, no words can explain the ring of streaming milk splashing the bottom of a galvanized pail, or the resulting cloud of steam on a frosted morning. After school and after a hurriedly devoured piece of Mom's home-baked apple pie, came the dreaded feeding of the chickens—not just 15 or 20, but thousands of them. After all we raised "broilers," you know, the chickens you buy in the supermarket. There was an abundance of feed to haul, grungy water fountains to clean, and yep, you guessed it, tons of chicken manure to shovel. I have enough memories to last a lifetime!

Don't get me wrong. Hard work was not readily appreciated as a lad. I was more than anxious to leave the farm at 17. Only years later have I come to understand the priceless gift handed to me. While enrolled in God's great school of the outdoors, I learned, though not readily, to accept the responsibilities my parents gave me. Even in struggling and bickering with my older brothers, I gradually came to understand the value of teamwork and the sense of accomplishment. Now, as I reflect even further, it was here that God molded me into much of the man I am today.

In modern-day America, children need the opportunity to experience the treasures of the outdoors. One hallmark of the Royal Rangers ministry is the huge emphasis placed upon the theme of outdoor adventure. Yes, camping becomes a vehicle for sharing responsibilities, mentoring youngsters, and leading them to the Great Creator, Jesus Christ.

Before Autumn leaves begin to fall, Commander, plan your next outdoor extravaganza. Take your outpost camping!

Awesome Aussie Adventure

by Randy Claunch

Ken Hunt, James Eubanks, David Shepherd, Dan and John Sprague, John Brown, and Randy Claunch left Los Angeles aboard a 747 jumbo jet on January first, with destination Australia. When we arrived in Sydney, Australia, we boarded another aircraft that was bound for our main destination: the 1997 Australian Camporama.

At the airport in Brisbane, Queensland, on Friday, January 3, our group was met by Regional Commander Will Thorne. Will took us to our new address, the Astor Motel. After we got ourselves settled in, Will, his son Michael, and Michael's wife took us out for an evening meal on the riverfront.

On Saturday we were able to acquire tickets for a tour of the nearby Sunshine Coast. After we boarded the Coachtrans bus, we were off for the first part of our adventure. Our group was able to see and tour places like "The Big Pineapple." This was 112 hectares of pineapple plantation. We rode through the Glasshouse Mountains, toured a ginger factory, and went to the Bunya Park Wildlife Sanctuary. There we saw our first kangaroo and Koalas. For lunch we stopped at the tourist resort of Noosa. In the evening we went to see the "Underwater World," advertised to be Australia's largest tropical oceanarium. Here we were able to go "under water" in an 80-meter tunnel that made an underwater observatory. After our return to the motel, we rested for awhile and then walked to the shopping district. Here we came upon a most interesting place to eat; it was called Kentucky Fried Chicken.

Then we headed back to the motel for some much needed sleep.

When we woke up Sunday, we were able to watch the second half of the San Francisco 49ers/Green Bay Packers play-off game. After breakfast we went to church. We attended Shilo Community Center, where Ken Hunt ministered to us in the morning service. For lunch we went to Mr. and Mrs. Michael Thorne's home for a backyard cookout. The evening service had a very international flavor; of course, Australia, the United States, and Papua New Guinea had members of their Royal Rangers groups attending. After the service, an afterglow of hot tea and spice cakes was provided.

Monday, after breakfast, we loaded the car with our luggage. We boarded a commuter train that would take us near our destination, Camp Watson, and the Camporama. Once at the camp we registered and were assigned a cabin room.

Tuesday we toured the Camporama sites and enjoyed watching the boys and girls trading patches

and other types of trade items. The FCF village had a log cutting demonstration, an area to learn how to pop a whip, and also a cooking area. The FCF headquarters building contained a display of the communications used through the years in Australia. As a part of this display, a series of PC terminals was set up and connected to the Internet. This building also displayed topographical maps, FCF clothing, and other FCF items that belonged to Will Thorne. We went to the lake to see the canoe adventure.

We also watched as the boys and girls boiled water in a "Billy Pot." We watched the boys and girls slide on the Flying Fox. This is a suspended cable about 150 feet long on which the Rangers were harnessed to a suspended pulley and seat, so they could safely slide down the distance of the cable. The Rangers were also able to participate in a spear throwing contest where they were scored both for accuracy and distance. At the pageant time, we were introduced to the evening speaker, Rev. Mark Bridgewater, who was a most dynamic speaker during each of the night services.

The Rangers and leaders enjoyed the wall climbing and the abseiling on a very large tower that was approximately three stores tall. Another event at the Camporama was the Pine Wood Derby. The boys and girls made their own cars on the site of the big race. Basketball and swimming were big events as was Cricket.



Thursday the pastor and his wife from the Taigum Gardens Assemblies of God Church took us up into the Glasshouse Mountains for a ride in the countryside. Here we were able to hike back into one of the national parks and see the eucalyptus bushland. It was beautiful! We arrived back at the Camporama site late in the afternoon, just in time for the international log sawing contest in the FCF village. Our team members were James Eubanks and John Brown—they won! After the competition was over, our guys were awarded the trophy—the log they has just sawed. Our heroes were able to refresh themselves before the evening pageant.

As a part of the evening service, a tribute was paid to former Australian National Commander Will Thorne. Commander Hunt presented the Medal of Merit to Will. An Oklahoma Indian headdress and a knife, made by the U.S. FCF President Fred Deaver, were also presented. Each of the other national delegations made similar presentations of honor and friendship.

On Friday morning, the Camporama activities came to an end. Commander Hunt made a presentation to Australian National Commander Warren Billson and he addressed the entire Rangers audience. He also made presentations of blowing horns to the representatives of Fiji, New Zealand, and Papua New Guinea. A

flyover and photo session were the concluding events of the Camporama.

Friday evening we were on our way back to Sydney. We arrived very late at our new address, the Southern Cross Bible College. This beautiful campus had been an Air Force base that the Assemblies of God group purchased and has made into a college.

Saturday we took the train into the downtown area. We toured Darling Harbor, went to the Sydney Aquarium, the National Maritime Museum, saw the Australia II, winner of the America's Cup Yacht Race.

The city rail system was very clean and comfortable. On the ride into town we met a lady who took the time to help us make the right connections. In our conversation with her, she revealed that she was the only survivor of her family from one of the atomic blasts in Japan toward the end of World War II. We rode back to the college and prepared for the Sunday services.

We went to church at Pietersham with Will (and daughter) Fiona Thorne. Ken Hunt delivered a dynam-

ic sermon to this body of believers. After church we traveled to the Thorne house for an afternoon of much needed relaxation. Sunday evening, we again went to church and were blessed by Ken's message. After the service we attended an afterglow in the church gymnasium before we re-turned to Southern Cross Bible College.

Monday was our last day in Australia. We met with Will at the train depot and he took the ride into town with us. We hired a guide to give us a tour through the old town part of Sydney known as "The Rocks." This was the early settlement area. As a part of our tour, we were able to see the New South Wales Parliament Building, the Royal Botanical Gardens, the Barracks (an early prison building), the oldest house in Sydney, and also a statue of Admiral Blythe, famous for Mutiny on the Bounty.

We then left our guide and went on the Harbor Cruise. We were able to see a prison island named "Pinch Gut," after first stopping at the Sydney Opera House for a photo session and souvenir purchases. After the cruise, we went to a restaurant where we had our last evening meal (seven course) with Will and Fiona. We then went to the Centre Point, a large tower in the center of Sydney. This was an awesome way to end our stay in Australia.

Tuesday, pastor Bill Wells and Will Thorne took us to the airport and helped us prepare for the 13 1/2-hour flight back to Los Angeles. This team of representatives from the United States would soon be going different ways to their individual homes.

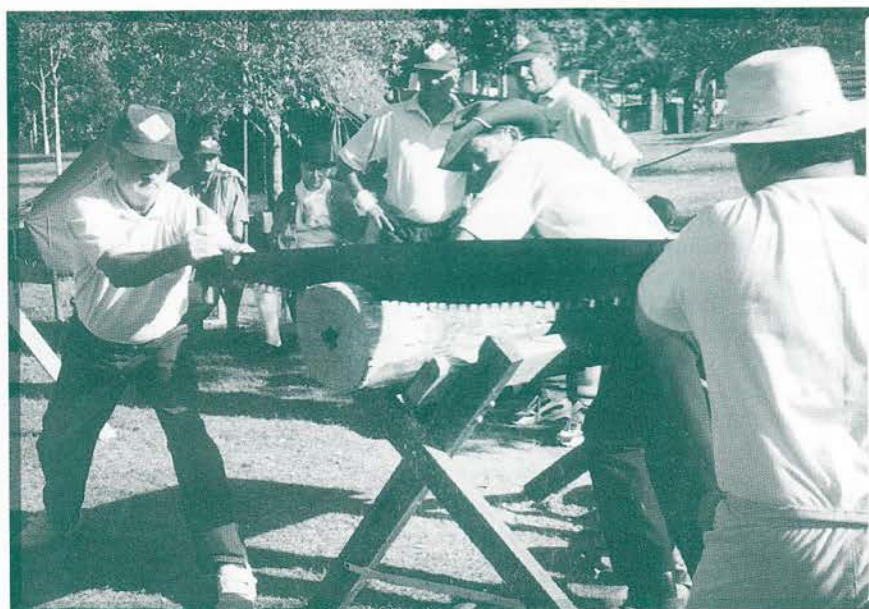

National Council Rings 'Revival'
by Brian Rogers

The spiritual level was high as Royal Rangers leaders from across the nation met in Springfield, Mo., for the annual National Royal Rangers Council, March 20-22, 1997. From the Silver Eagle banquet, which kicked off the council Thursday night, through the concluding Light-for-the-Lost Junior Councilmen's Banquet Saturday, the Spirit of the Lord was clearly present.

"Lord, Send a Revival" (Psalm 85:6) was the theme of the opening banquet, during which district commanders were recognized for excellence in service. Rev. Charles Crabtree, assistant superintendent of the Assemblies of God, was the keynote speaker. He challenged the record crowd of 425 to earnestly and persistently desire revival, based on Matthew 7:7.

The highlight of the banquet was the presentation of Silver Eagle Awards to district commanders for their outstanding service in 1996. Of 56 district commanders, 35 received the Silver Eagle Award.

A short video *Pathfinders: Finding a*



Way—highlighting Frontiersmen Camping Fellowship Pathfinders, the Royal Rangers overseas MAPS: Construction arm—was shown at the banquet. This video surveyed some of the overseas missions projects in which the Pathfinders have been involved. Pathfinders go into areas where living conditions are too harsh for most overseas MAPS/Construction teams to minister.

With 289 councilmen registered and 93 councilmen's wives in attendance, many reports were read and several resolutions were passed during the business sessions Friday and Saturday. Following are reports presented at the National Council:

•*Latin American Training Camp*

Latin American Missionary Doug Marsh reported on the development of Camp Summit, the future national training center in Costa Rica. Marsh noted that over \$34,000 was needed by April 23 to

deplete the loan balance on land purchased for the proposed camp. Donations and pledges totaling \$47,568 were made. In addition, several districts pledged funds for a future building program to develop the land.

•*Straight Arrows and Buckaroos Programs*: Scott Mandeville, national coordinator of the Straight Arrows/Buckaroos Committee, reported that his committee is totally revising the Straight Arrows and Buckaroos programs, under the direction of the national office. His recommendations for new Advancement Trails for these programs were favorably received during the Executive Committee meeting, held prior to National Council. He presented plans to improve the uniforms and curricula for these programs before the turn of the century.

•*Harvest Task Force*: Marshall Bruner, national Harvest Task Force coordinator, presented the Harvest Task Force: *Breaking Powers Through Prayer* video. The footage highlights an HTF in Providence, R.I., where commanders throughout the nation gathered to fast,

pray, and evangelize the children of that area. Marshall challenged each district commander to conduct at least one HTF per year. He reported that a Challengers program, called Harvesters, is being developed to challenge young men to greater spiritual growth while partic-

ipating in evangelism endeavors. Marshall further noted that one of the requirements for a Harvester will be to participate in an HTF and that district commanders need to begin scheduling HTF's in which the Challengers can participate.

•*Programs Report*: David Craun, Programs Committee chairman, reported on the progress of the new Challengers programs. The Trail Rangers program has been revised and is now in production at Gospel Publishing House. The Air and Sea Rangers programs are being revamped to fit the Challengers Advancement Trail. And other programs are in planning.

•*1998 National Camporama*: Our joint goal is to have 5,500 campers at the 1998 National Camporama. The poll taken during council revealed an expected attendance of 5,883 boys and men. Sample applications and Camporama packets were

distributed and discussed.

•*Legal Affairs*: Richard Hammar, legal counselor for the General Council of the Assemblies of God, addressed the councilmen for over 1 hour concerning child abuse and liability prevention. Please stress in your district events and newsletters the important steps noted in the *Royal Rangers Leaders Manual* on child abuse prevention. We must create safe outposts for our boys.

•*Camp Summit, Costa Rica*: Latin American Foreign Missionary Doug Marsh requested help from our councilmen, stating we were his last hope. Doug had an outstanding debt of over \$34,000 that was to be paid in full by April 23 for a loan to purchase land for the future Royal Rangers training center in Costa Rica. As he did at the 1996 National Council, Doug explained his vision to establish a national training center, called Camp Summit, that would be a gathering point for Latin America to train Royal Rangers leaders. Once again you councilmen rallied to the cause. Donations and pledges totaling \$46,568 were made. Additional funds were also pledged for the building program to develop the land.

I want to thank you, commander, for giving from your heart your personal, district, and/or regional finances. May God bless you greatly for your contributions. If you have not done so, please forward your contributions to the Division of Foreign Missions, in care of Doug Marsh, project 7474. Mail your contributions for Doug to Division of Foreign Missions; 1445 Boonville Ave.; Springfield, MO 65802-1894.

•*Holy Communion*: This year's council concluded with holy communion, as we jointly celebrated the resurrection and soon return of Christ Jesus. It was a mov-



Jacque Blauvelt of Springfield delights us with a variety of songs

ing time as God's presence became so real.

Immediately after the dismissal of council business, we each made our way here to the Assemblies of God Headquarters, where we held the Light-for-the-Lost Junior Councilmen Banquet. The decor and dress was set to the theme of railroad. The event gathered 256 councilmen. Again, we enjoyed the delicious ribs prepared by the Southern Missouri District LFTL men. Thank you, Don Jacques and Benny Ferguson, coordinator for the national Light-for-the-Lost Office, for making this event possible. Royal Rangers from Outpost 6, Central Assembly, Springfield, served at the banquet as part of their requirements for becoming LFTL Junior Councilmen. Rev. Sam Kaunley, senior associate pastor of Central Assembly, Springfield, was our guest speaker. God's Spirit was felt so strongly that we could not conclude as normal with a time of goal setting for our two Junior Councilmen projects. Instead, we basked in the presence of Almighty God as He illustrated once again that He is moving us into a time of refreshing, of revival.

On Sunday, March 23, the District Leadership Training Seminar was conducted back at the Clarion Hotel. There, 166 councilmen attended workshops on improving district leadership skills. The seminar concluded with an open forum with the national staff.

The next day 33 men and women attended the Royal Rangers Turning Point Seminar, a 9-hour seminar held here at Headquarters that is designed to teach commanders how to help Rangers avoid or overcome life-controlling problems plus information on how to use the *Insight Group* curricula in the local outpost. Eventually this seminar will be a prerequisite for all IT's, so they will have a working knowledge about the seminar and curriculum when discussing it during *Leadership Training Course* training.

South Central Regional Seminar: Largest Ever

by Marvin J. Lemke, training coordinator, South Central Region

The South Central Regional Training Seminar was held January 24, 25, 1997, at Calvary Assembly of God, Waco, Tex. The activities began Friday, January 24, at 9 a.m. with the regional business council. That evening the McLaughlin Brothers ministered through Spirit-annointed Southern Gospel music. About 700 commanders, their wives, and others attended

the Friday night service. What an exciting time we had as lives were blessed—six men came forward for salvation.

Our hearts were challenged on Saturday morning with an outstanding message from Fred Deaver, national president, Frontiersmen Camping Fellowship. Marshall Bruner, national Harvest Task Force coordinator, also spoke on urban ministries, and men's heart were touched by the Holy Spirit to go into the inner cities and reach boys for Jesus. As a result many men committed to attending the region's first National Urban Leadership Conference, held in Dallas, Tex.

On Saturday approximately 500 attended a variety of seminar classes for pastors, regional councilmen, Trail Rangers, and leaders of all grade/age groups. Lunch that day included a great Texas barbecue, served by the Royal Rangers of Calvary Assembly in Waco.

I appreciate everyone who attended and pray that you were blessed and your outpost increases for the glory of God. The South Central Regional Seminar continues to grow, and next year we are setting our goal at 1,000 for the Friday night service. Glad Tidings Assembly of God in Austin, Tex., will be the host church for 1998.

Royal Rangers & Light-for-the-Lost

Congratulations to the following commanders who have earned the Light-for-the-Lost/Royal Rangers membership pin with one sapphire stone (the stone represents the enlistment of five Royal Rangers in a given year into the Junior Councilmen program). The 1996 recipients are:

- Emanuel Burkholder, N. Mo. District
- Michael Fry, N. Calif./ Nev. District
- Ed Rankin, Okla. District
- Steve Adams, Pacific Latin America District
- Brian Schmid, Wisc./N. Mich. District
- Dale Pluskota, Wisc./N. Mich. District
- Ken Gray, Northwest District

- Sid Lehman, Ind. District
- Julian Phillips, Pen. Fla. District

Christmas Boxes for ChurchCare America Project for Royal Rangers

Are you ready to help? We know you're a great giver. Here's a Christmas project for your Rangers, with advance notice so your outpost will be "ready" to give.

Collect a shoe box for each boy in your group. Let each boy decorate his box Christmas-style.

Then encourage the boys to bring items, such as those suggested below, to help fill their Christmas Box gifts—or help the boys raise funds to purchase these items.

The box stuffers should be geared toward boys ages 3-10 and should contain at least one toy. Please label each box with a specific age range—i.e., ages 3-4, ages 5-7, ages 8-10). Here's some examples of what boys can put in their Christmas Boxes:

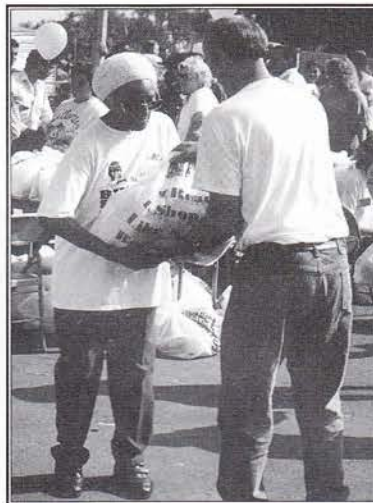

- toy
- pencils, pens, markers
- notebook
- coloring book
- crayons
- reading book
- baseball cards
- baseball cap
- matchbox car
- marbles
- candy
- fruit snacks
- gum
- toothpaste
- toothbrush
- character bandages

This project will enable needy boys to receive a gift for Christmas. Please send the Christmas Box gifts by November 25, 1997, to the below addresses.

Mailing: ChurchCare America
P. O. Box 1476
Springfield, MO 65801

Shipping: ChurchCare America
1445 Boonville Ave.
Springfield, MO 65802

Royal Rangers

Departmental Items



National Royal Rangers Office; 1445 Boonville Ave.; Springfield, MO 65802-1894

National Office Items Now Available

Call 1-800-641-4310

Below are several Royal Rangers products that are ideal for outpost application. Prices below do not include shipping fees. Order direct by calling 1-800-641-4310.

● *Reaching Boys for Christ*

The 3:38-minute promotional video conveys the problems today's youth face while focusing on our unique approach to reaching boys for Christ.

Item Number: 729NZ128
Cost: \$10

● *Harvest Task Force: Reaching Urban America*

The 5:28-minute video promotes the National Urban Leadership Conference and focuses on the urban thrust of the Royal Rangers ministry.

Item Number: 729NZ129
Cost: \$10

● *Harvest Task Force: Breaking Powers Through Prayer*

The 5-minute video promotes the National Harvest Task Force efforts. The Royal Rangers HTF is designed to target key areas where commanders gather to fast and pray and to participate in evangelism efforts. The national Royal Rangers Office hosts yearly HTFs in addition to the district-sponsored HTFs. This video is ideal for commanders who want to promote the Harvest Task Force.

Item Number: 729NZ064
Cost: \$10

● *The Book of Hope*

The Book of Hope is ideal for urban evangelism in African-American communities. The Book includes the story of Jesus, based on the New International Version of the Gospels, and includes preface pages on God's answers for today's urban issues.

Item Number: 729HC120
Cost: \$.55 ea. per 500-plus
\$.65 ea. per 100-400

● *Frontiersmen Camping Fellowship Brochure*

The full-color brochure is ideal for promoting FCF. It describes the FCF program, lists membership requirements, and includes an area for listing the distributor's address and telephone number.

Item Number: 729NZ018
Cost: \$.10 ea., min. order 100

● *Rangers WinTracker*

The software program for DOS computers with Windows enables a commander to effectively track the advancements and profiles of his Royal Rangers. The program includes both the old and new Advancement Trails.

Item Number: 729NZ140
Cost: \$55

● *Rangers Trailtracer*

The software program is designed for DOS computers without Windows. It enables the commander to create profile sheets for each Royal Ranger and to track his advancements under the new Advancement Trail.

Item Number: 729NZ141
Cost: \$45

● *The Ten Commandments*

The Ten Commandments (leader's guide and group guide) offers 13 Bible study lessons on the Ten Commandments and the study topics of "Preparing My Heart," "Law and Grace," and "The Mission Statement."

Item Number: 729NZ150
(leader's guide)
Cost: \$10
Item Number: 729NZ151
(group guide)
Cost: \$8

● *Gold Medal of Achievement Bulletin*

The 11- by 8 1/2-inch format, which folds in half, enables the user to print the GMA ceremony schedule and service activities on the opposite side, which has a full-color design.

Item Number: 729NZ069
Cost: \$15. per 100

● *The Youth Bible*

Contains numerous devotional topics ideal for any outpost group meeting. Commanders now have a host of youth issue devotionals at their fingertips.

Item Number: 729NZ106
Cost: \$17

● *Walk Thru the Bible*

An excellent method for teaching Rangers about the Books of the Bible and their central themes. Colorful cartoons associate the theme with the name of each book in a bright, fun, and unforgettable way.

➤ *Old & New Testament
Coloring Book*
Item Number: 729NZ114
Cost: \$10.95

*The coloring book is ideal for
Straight Arrows and Buckaroos
groups.*

➤ *Old Testament Flash Cards*
Item Number: 729NZ118
Cost: \$6

➤ *New Testament Flash Cards*

Item Number: 729NZ119
Cost: \$6

➤ *Old & New Testament Overheads*

Item Number: 729NZ117
Cost: \$79

The flash cards, used to reinforce learning, are ideal for all age groups. The overheads enable the commander to address the entire group as he/she teaches—also ideal for all age groups.

● *The Ultimate—English*
Item Number: 729NZ007
Cost: \$.05, min. order 100 *

● *The Ultimate—Spanish*
Item Number: 729NZ010
Cost: \$.05, min. order 100 *

The brochure highlights the "ultimate experience" for a boy, Royal Rangers, then presents the salvation message. This evangelism tool is ideal for canvassing neighborhoods to invite boys to Royal Rangers. The brochure is designed so that the outpost number and telephone number can be printed on the back of it.

* Both English and Spanish versions of *The Ultimate* brochure may be obtained free of charge by outposts unable to afford the cost or by outposts conducting outreach ministry. Such outposts must request the items through the national Royal Rangers Office and must pay for shipment.

● *Urban Commanders Training Guide*

A 66-page training manual that offers new insights to penetrating urban America with the Royal Rangers ministry.

Item Number: 729NZ009
Cost: \$6.50

● *Urban Rangers—Dallas, Chicago*

The video highlights urban Royal Rangers in Dallas and in Chicago—an excellent tool for promoting urban ministry.

Item Number: 729NZ052
Cost: \$10

● *Insight Group: Commander's Guide*

Item: 729NZ049
Cost: \$9

● *Insight Group: Ranger's Guide*

Item Number: 729NZ050
Cost: \$7

The *Insight Group* curricula is ideal for groups Pioneers age and up. *Insight Group* provides 13 sessions that are ideal for monthly meeting features or a weekly 30-minute values/Bible study. *The Commander's Guide*, a 104-page guide, instructs the leader how to use the curriculum along with the materials that are presented in the *Ranger's Guide*.

● *Victor's Victories*

For Straight Arrows and Buckaroos commanders: Contains 13 stories with Bible studies and discussion topics that address issues today's young boys face: the single-parent home, death is not the end, controlling anger, peer pressure and gangs, friendship, the importance of winning, and much more.

Item Number: 729NZ057
Cost: \$18

● *The Solid Rock*
Video & curriculum series

➤ *Kids 'n' Gangs*
Item Number: 729NZ100

➤ *Streets of Pain*
Item Number: 729NZ101

➤ *Who Is God?*
Item Number: 729NZ102

➤ *Finding God's Will for Your Life*
Item Number: 729NZ104

➤ *Looking for Life in All the Wrong Places*
Item Number: 729NZ105

Cost Each Packet: \$32.95

Each packet contains a video on the youth issue and a leader's workbook that can be duplicated.

● *Meeting Feature Videos:*

➤ *I Didn't Do It*

Topic: Telling the truth
Audience: Straight Arrows, Buckaroos
Item Number: 729NZ107
Cost: \$14.99

➤ *Strangers*

Topic: Child Abduction Prevention
Audience: Straight Arrows & Buckaroos
Item Number: 729NZ108
Cost: 14.95

➤ *Decisions & Consequences*

Topic: A look behind prison walls; teaches the consequences of sin
Audience: All age groups
Item Number: 729NZ109
Cost: 19.95

➤ *Incest: Solving the Pain*

Topic: Child abuse prevention
Audience: Commanders
Item Number: 729-110
Cost: \$19.99

● *Urban T-shirt*

Size L: Item Number: 729NZ058

Size XL: Item Number: 729NZ059

Size XXL: Item Number: 729NZ060

Cost: \$9

● *Urban Cap*

Item Number: 729NZ067
Cost: \$8.50

● *Thumbs Up Football Game*

➤ Football Pack — 12 games
Item Number: 729NZ300
Cost: \$35.95

➤ Football Pack—24 games
Item Number 729NZ301
Cost: \$69.95

➤ Football Game Set
Item Number 729NZ302
Cost: \$15.99

➤ Outpost Pack
Item Number 729NZ303
Cost: \$18.85

Rangers in Malaysia

by
Darrell
Smith

The first outpost in Malaysia, Selangor #1, was started by Pastor Albert and a few others in August 1982, at Grace Assembly, Klang. Currently they have 14 active outposts, plus 3 new ones that will be starting soon. Two inactive outposts are in the process of being revived. Total chartered commanders stand at 100, while Royal Rangers are at about 1,000. In Malaysia both Royal Rangers and Missionettes programs are available. However, they are allowed by the constitution of the Assemblies of God in Malaysia to accept girls in our Royal Rangers program, beginning with Straight Arrows.

During their second Camporama in June 1996, 20 souls were added to the Kingdom, about 50 baptized in the Holy Spirit, and 100 responded to a full-time call to Christian service. The attendance was 500. There have been pockets of revival in outposts all over Malaysia. Royal Rangers are bringing their friends and classmates to church and eventually to Christ.

Training in Malaysia

The Royal Rangers in Malaysia have conducted two Camporamas, four NTCs, and three JLTCs so far, with countless Pow Wows, Roundups, leaders' banquets, and other events. The national commander is Albert Ong; national director is Rev. Dr. Henry Ramaya, and the national training coordinator is Mike Kunaseelan. None of the above are full-time in Royal

Rangers, nor are any of the other national committee members.

Pastor Albert runs an orphanage called Rumah K.I.D.S. (K.I.D.S. Home). Rev. Dr. Henry is the senior pastor of two large churches with 20-plus outreaches. Commander Mike and the committee members work in secular jobs.

Malaysia's First NTT

Many of us who hike in the United States are accustomed to trail markers and topographic maps with books giving you information on the trail you are about to hike. In

and myself. We arrived in Malaysia on Monday, November 11, 1996. At this point we had planning to do for the camps we were about to embark on: ANTT, ANTC, NTC, Staff School, ICS, and IT, all in 3 weeks. First was the NTT. The men of the American team met with Albert Ong, Herbert Ong, Jeffery Lim of Malaysia, and Roy Tay from Singapore. Let me say that all those who were involved on this 3-week adventure were of the most outstanding character. A finer group of men and women I have not met, and I will be friends with them for a lifetime.

We headed off to the rain forest to meet 20 men, 4 women, and a group of trainees from Malaysia and Singapore at the rendezvous point. In these countries, women are just as involved as the men and boys. It was time for the first classes—a fun time for everyone. As the first day ended, we set up camp. A dinner of rice and chicken was prepared.

Camp was struck and we were



the Malaysian rain forest the termites, panthers, monkeys, baboons, and cobras, to name a few, know where they are going—we don't. The American team was made up of Paul Stanek, David and Amy Craun, Bob Posey, Jim and Este Eubanks,

off on the trail at 7:30 a.m. with a few classes along the way.

We were almost on the equator and it did not take long for the humidity and the heat to settle in. There is no way to escape it. As we got further into the rain forest, new

creatures emerged. We found that leeches had gotten on a few of us. I was lucky to make the whole trip without one!

We finally arrived at the campsite, set up camp, and then started dinner. We had rice and sardines in tomato sauce. What a pleasant surprise—I had not had rice in a long time! During one of the class sessions, while I was teaching about tents, out of one of the trees came a green lizard. I believe it thought my tent was some distant cousin. Soon another day was over.

Malaysia's First NTC Staff School

With training getting really off the ground, it was important to hold a staff school. Back in the States we often do not see the needs of another country just as is the case here. All of the materials that are printed do not always apply here. The Nature Study class was interesting. Many of the plants we have in the States are not present in Malaysia, such as poison oak and poison ivy. Some of the plants there are not found in the States.

Most of the classes were in a small room, with the exception of those like Rope-craft, Nature Study, etc. The needs are the same. Much of the material will have to be edited by their staff so it will work in their setting. By now many of us are feeling exhausted from all that has gone on, even sometimes drifting off in a catnap here and there. The staff school was a cram course, giving both instructors and students very little time to get ready.

Despite the shortness of time and the many changes between the United States and Malaysia, they are hanging in there. We have been adjusting the material to meet their culture, sometimes with great success.

ANTC

Time was closing in on the most important camp of the trip. Again

the camp would take place in the rain forest. However, this time it will be 2 hours away in the state province of Malacca. This city we have found to be rich in history.

The staff and supplies were divided into four small cabins, two beds each. As we began to set up camp and find out what was available, Bob Posey and Albert Ong came upon a cobra less than 10 feet away from where kids were playing in the park.

As the patrols finished their breakfast, we were putting the final touches on our class site. I thought back when I was in Iowa at the ANTC and Paul asked me to go on this trip. Never had I imagined what it was going to be like. It is a shame that a lot of people in my home district think I only play. Of course, not many have a job that they love as much as I do mine.

So, on with the task of the day. The first group of women out of the two patrols that were present had someone we nicknamed "Mother Teresa." One of the guys taught a group of women how to make outfits and costumes. It was great to have Amy Craun and Este Eubanks working with me. Even then it was strange to watch the other women construct their rope bridge. All the

classes were a success. Many had been at the NTT and staff school, like May Lai and "Mother Teresa." Jeffery and his wife Li Lian, still newlyweds, were all together having a great time in the Lord. The camp continued without major problems until the end.

We had so much fun even though we had a lot to overcome. The ANTC was a success and one we will not soon forget.

Training in Malaysia was an incredible experience for us all. Sometimes we get sheltered in our own little world and forget that God is doing mighty things and working mighty miracles, even as far away as Malaysia.

CORRECTION

Our thanks to Mike and Cathie Laurain for the article "A Day At the Farm," which appeared in the summer 1997 High Adventure Leader, pages 9, 10.

Straight Arrows and Buckaroos commanders, if you have not done so, be certain to file this article for future ideas on activities for younger Royal Rangers.

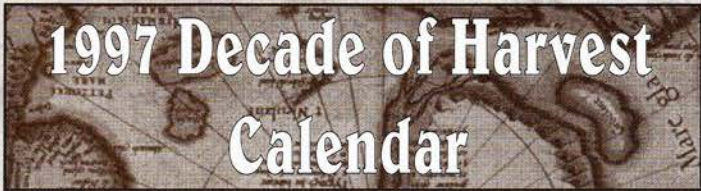

1997 Decade of Harvest Calendar

September							October							November						
S	M	T	W	T	F	S	S	M	T	W	T	F	S	S	M	T	W	T	F	S
	1	2	3	4	5	6			1	2	3	4							1	
7	8	9	10	11	12	13	5	6	7	8	9	10	11	2	3	4	5	6	7	8
14	15	16	17	18	19	20	12	13	14	15	16	17	18	9	10	11	12	13	14	15
21	22	23	24	25	26	27	19	20	21	22	23	24	25	16	17	18	19	20	21	22
28	29	30					26	27	28	29	30	31		23	24	25	26	27	28	29
														30	31					

Crafts

Folding Camp Table

by Steve Hamby

(C2). Later it will be used to attach (C2) to (C1) with (E).

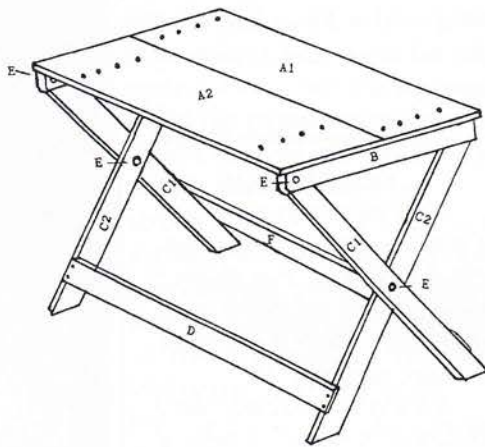
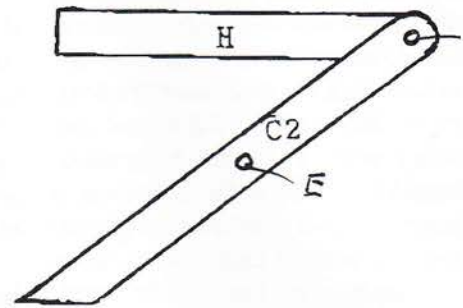

8. Get 24 number 10 X 1 1/2-inch flat-head wood screws.

9. Get 6 finishing nails 1 1/2 inches long. They are used to keep dowel rods (E) and (G) in (C1) and (C2) after they are put together.

Fasten one leg (C1) to tabletop support (B) by drilling a 5/8-inch hole 1 3/8 inches from the end. Then put dowel rod (E) in the hole. Round off the square ends to round ends on (C1) and (B) as shown in diagram below. Drill another 5/8-inch hole 16 inches from the bottom of the leg (C1). Later it will be used to attach (C1) to (C2) with (E).

Repeat this procedure for other inside leg and tabletop support. Only fasten (C2) to the opposite side of (H) as in the previous instructions. Attach this leg and support to the other end of dowel rod (G).

The tabletop (A2) is attached to tabletop supports (H) 4 1/2 inches from the edge of (A2) and 3 1/8 inches from the side of (A2). See diagram below.

Repeat this same procedure for the other outside leg (C1) and tabletop support (B). Only fasten (C1) to the opposite side of (B) as in the previous instructions.

Fasten one leg (C2) to tabletop support (H) by drilling a 5/8-inch hole 1 3/8 inches from the end. Then put one end

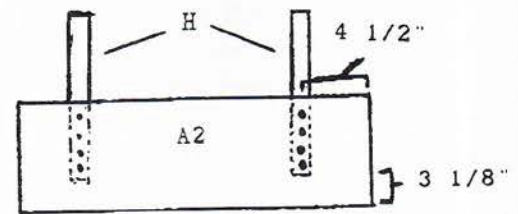

1. Cut 4 legs, 2 3/4 inches wide and 27 inches long (C1, C2).

2. Cut 4 tabletop supports, 2 3/4 inches wide and 15 3/4 inches long (B, H).

3. Cut one piece, 2 3/4 inches wide and 17 1/4 inches long (D). This is the leg brace for the inside legs.

4. Cut one piece, 2 3/4 inches wide and 19 inches long (F). This is the leg brace for the outside legs.

5. Cut 2 tabletop pieces, 11 inches wide and 24 inches long (A1, A2). All of the wood is 1-inch planed stock, which is actually approximately 3/4 inch thick.

6. Cut 4 pieces of 5/8-inch diameter dowel rod 1 1/2 inches long (E).

7. Cut 1 piece of 5/8-inch diameter dowel rod 17 1/2 inches long (G).

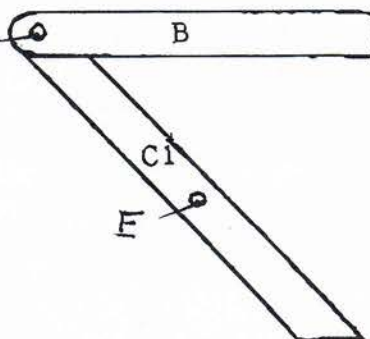

of dowel rod (G) in the hole. Round off the square ends to round ends on (C2) and (H) as shown in the diagram below. Drill another 5/8-inch hole 16 inches from the bottom of the leg

The tabletop (A1) is attached to tabletop supports (B) 2 1/8 inches from the edge of (A1) and 3 1/8 inches from the side of (A1). See diagram below.

After you have put the tabletop on the

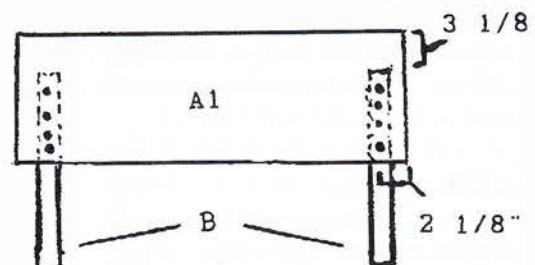

supports, slide the inside legs (C2) inside of (C1) and put dowel rods (E) in both legs. Attach leg brace (D) 5 inches from the bottom of legs (C2). Attach leg brace (F) to (C1) the same distance from the bottom of legs (C1). After you have unfolded the table a few times, put the finishing nails in legs (C1) to keep dowel rods (E) in place. Also place finishing nails from (C2) into the long dowel (G) to keep it from sliding out.

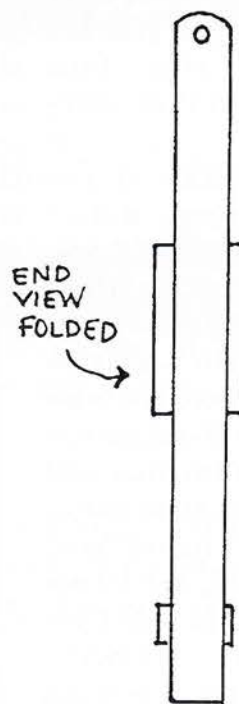
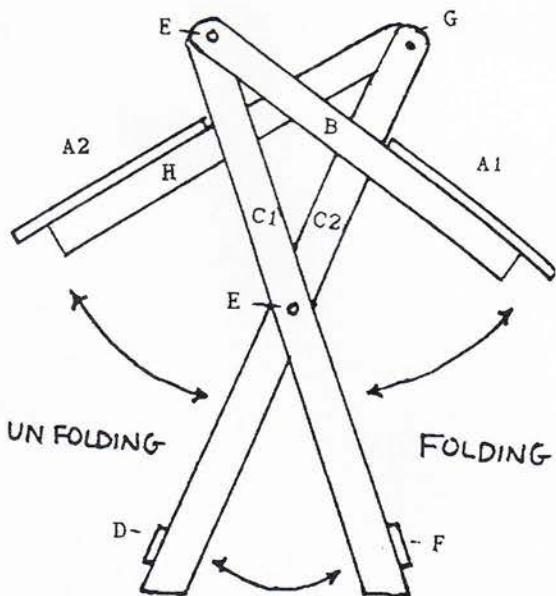
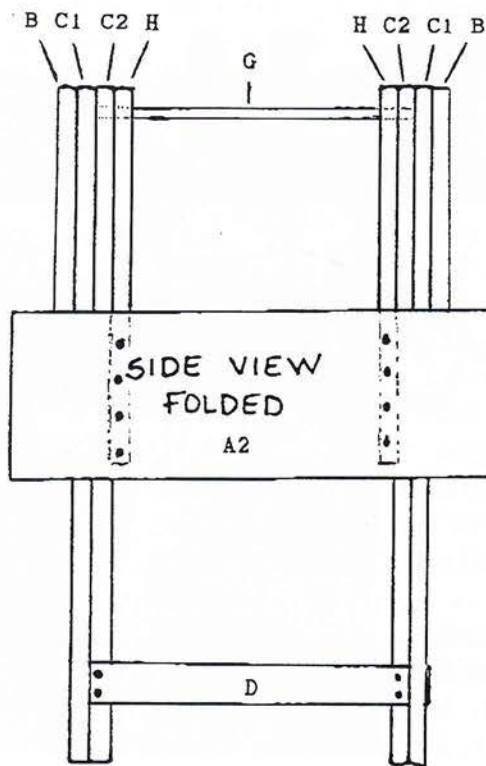
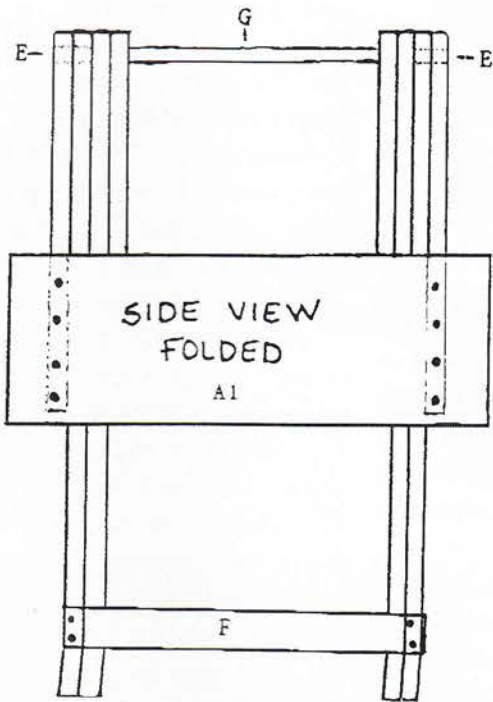

Michigan Pathfinders

by
Jerry
Midkiff

The Michigan District Royal Rangers and the Henry Rowe Schoolcraft Chapter of Frontiersmen Camping Fellowship successfully completed their Pathfinder trip to El Cyuo, Mexico, on January 18, 1997. El Cyuo is a small fishing village located 75 miles west of Cancun on the Yucatan Peninsula.

The building project was directed by Missionary Dave Cave. The joint construction team consisted of members of the El Cyuo Assembly of God and the following men from Michigan: Arden Frey, Jerry Midkiff, Richard Geno, Stan Bonk, Dave Stutzman, David Sabin, Jerry Bima, Robert Warrick, Tom Pawlawski, Dennis Klug, John Reich, Hugh Heikkliä, and Austin Parkin.

We left subzero weather at Detroit Metro Airport, and landed 3 hours later in 80-degree sunshine at Cancun International Airport. Our adventure started with a 2-hour wait for our transportation. Six long, hot, bumpy hours later we arrived at El Cyuo by cars and trucks. The next 7 days made a lasting impression on the Pathfinders team. Daily devotions were led by team members. The theme of the trip was

Deuteronomy 31:8: "The Lord himself goes before you and will be with you; he will never leave you nor forsake you. Do not be afraid; do not be discouraged." The Lord truly went before us, as we had no major problems on the trip.

The building project was to finish the cement roof and to build wooden pews. We not only built the church building, but we also helped to build the church body, as every service had tremendous results. Attendance at services increased from 16 to over 130, and over 60 individuals came forward for salvation, healing, and family ministry. We saw many miracles. Babies were prayed for and the fever left their

small bodies. Many men cried openly for forgiveness, and marriages were put back together. There was an openness to the gospel of Jesus Christ as Lord and Savior.

The powerful midweek service was conducted by Superintendent Silverio Blanco from Progreso, Yucatan. The service also included two baby dedications. Each service had worship and praise sessions in both English and Spanish. A highlight for the group was when we taught the children a song from Ephesians 3:18: "How wide and long and high and deep is the love of Christ," in Spanish including the hand motions.

When I returned to the "Campground," I saw three young boys gathering the fruit of the prickly pear cactus. The fruit is a deep ruby red, golf ball-size grape. Getting to the fruit can be very dangerous because of the thorns that surround the fruit and plant. As I saw Miguel limping, I tried to ask, "What is wrong?" We used sign language to communicate as I knew no Spanish. When he showed me his heel, I knew what was wrong. I used

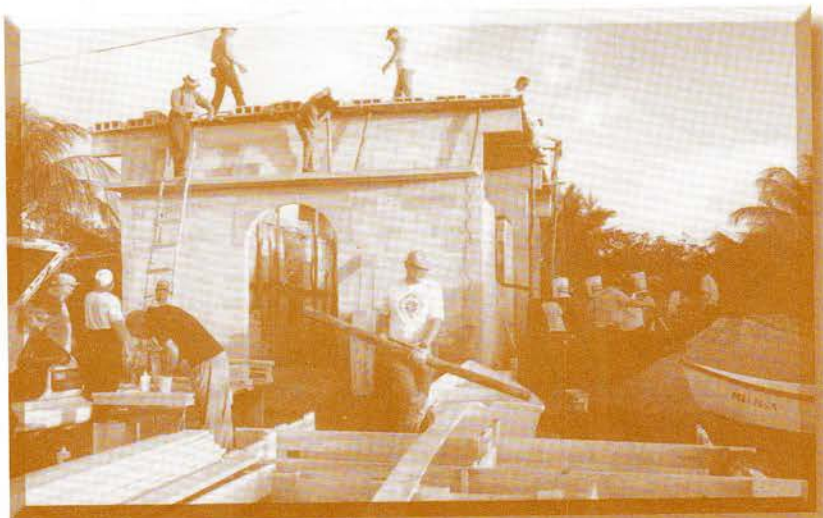

Dave Stutzman's tweezers to pull out the half-inch thorn from his heel. From that moment on I had a friend. Sharing a piece of turkey jerky with my new-found friends, I also shared John 3:16 in our new-found communication. What an opportunity to share the gospel all because of a thorn in the heel of a small boy.

The trip had many other outstanding moments, including the delicious local delicacies which always included cabbage. The boys won the baseball game between the construction crew and the local

boys. We will long remember the hard working congregation, and the many new friendships.



We will never forget pastors Carlos and Leonardo, and our other friends Juan, Santos, Thomas, Jose, Tex, Bill and Jean,

and our interpreter Ruben Luna.

The church will be a lighthouse in the small fishing village.

Please continue to pray for missionary Dave Cave and Pastor Leonardo and the congregation of El Cyuo Asambleas de Dios. The severe cold we returned to in Detroit could not

dampen the flame of the Holy Spirit that burned within us.

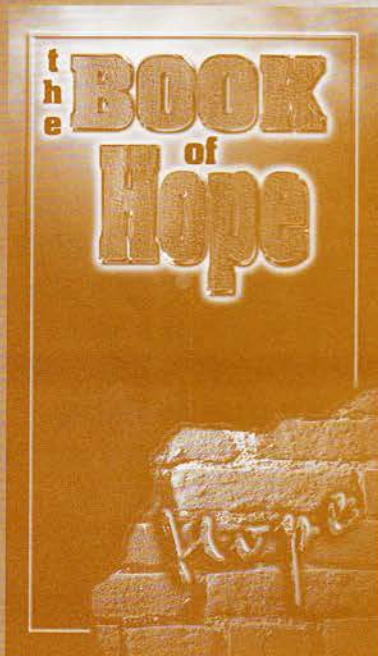

Newly revised Book of Hope!

The Book of Hope is ideal for evangelism. *The Book* includes the story of Jesus, based on the New International Version of the Gospels, and includes preface pages on God's answers for today's issues.

Item Number: 729HC120
 Cost: \$.55 ea. per 500-plus
 \$.65 ea. per 100-400

This product was made possible through the LFTL Junior Councilmen program. To order, call 1-800-641-4310 and request item 729HC120.

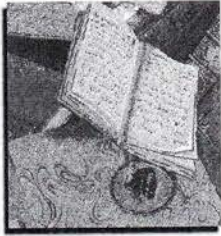

Devotionals For Boys

by Rev. David Boyd

Scripture verses
cited from the
New International
Version.

Lesson One

Supplies: an ugly gift

Have all of the children bring a gift to give away. Allow them to only spend a dollar or two. Collect the gifts from the children at the beginning of class.

Before class, purchase a really nice gift, but wrap it in a very poor looking package. Choose a gift that the class would really like. A good idea would be to wrap up a \$10 bill. Wrap it in a small box. Use a bow that is torn up and looks reused. It is important in this lesson to make this present look as ugly from the outside as possible.

Put all of the presents in the middle of the floor and place the children in a circle around the presents. Select one child to start and allow him to pick a present and open it. Allow the child to the right of the first child to go next. Continue until someone chooses the ugly gift. Allow yourself to go last. There is a good chance that the ugly gift will be the last one chosen.

Whenever the ugly gift is chosen, talk about the way we all naturally judge things by the outside. Explain that sometimes we avoid certain children because of the way they look or dress. Jesus wants us to reach out to everyone in this world. God loves everyone.

First Samuel. 16:7 says, "But the Lord said to Samuel, 'Do not consider his appearance or his height, for I have rejected him. The Lord does not look at the things man looks at. Man looks at the outward appearance, but the Lord looks at the heart.'" Jesus died on the cross for everyone. He sees what's on the inside. Explain that sometimes very "plain looking" children can become wonderful, fun-loving friends.

Lesson Two

Supplies: Some small simple item such as a marble or a golf tee

Choose a child to step out of the room. Have

someone in the class hide a small object like a marble or golf tee somewhere in the room. Choose two volunteers. Instruct the volunteers. They can only say the words "warmer" or "colder." One of the volunteers will try to delay the child who is searching by saying "warmer" and "colder" at the wrong times. The other volunteer tries to help the child to find the item by saying "warmer" when he is getting close to the item and by saying "colder" when he is drawing away from the item. Bring in the child. Explain the role of the two volunteers. Identify them and explain that one of them is trying to help the search and one is trying to hinder the search. On a signal the child searches around the room. The two volunteers shout out "Warmer" or "Colder" as he nears the object or moves away from it.

The rest of the children are to remain quiet. The child must decide who to believe.

Explain the spiritual application to this game. God tries to lead us in the right things to do and the devil tries to tell us things that are opposite of what is really beneficial to us. We need to learn to recognize the right voice to follow. Who do we follow? God's instructions or Satan's?

Lesson Three

Supplies: Bibles for each child

This game helps children to remember the order of the books of the Bible. Start with a limited number of books of the Bible. Allow the class to use their Bibles to find the answers. As their knowledge and skills improve, include more and more books. If your class is good at this and you have a visitor, allow the visitor to use his Bible.

To begin, the teacher calls out either the word "before" or the word "after" followed by a Book of the Bible. (Example: "Before Acts") Children must stand up and shout out the book of the Bible that comes just before the book of Acts which is "John." Children can only stand up and shout once per question. They need to

think of the answer before they shout. Reward each child who gets the right answer with a small item such as a treat. Put a limit on how many rewards one person can get.

Remember, allow the children to use their Bibles. This teaches them where the various books of the Bible are and in what order they are found.

Explain to the children the importance of the Word of God. Encourage them to value their Bible and help them to learn to be familiar with it.

Lesson Four

Supplies: A glass of water, a live plant

Pick a volunteer from the audience who says he is thirsty. Give him a glass of water and ask him to drink it. When he has had enough, ask him if he thinks that he will ever get thirsty again. When he says he will, compare this to thirsting after God. You need to spend time praising God on a regular basis, not just once here and there.

Hold up the plant and reinforce this truth. Will the plant live if it gets water only once? Of course not, a plant needs water daily or weekly. A

plant must fill itself with water or it will die. We must fill ourselves with praise towards God.

The Bible says in Psalm 143:6, "I spread out my hands to you; my soul thirsts for you like a parched land." God's Word instructs us to worship God. It instructs us to thirst and seek after Him like a desert thirsts for water.

Pick several boys and take their fingerprints using a ink pad and paper. Talk about the uniqueness of fingerprints. Explain that no two people on the earth have the same fingerprints. No one can duplicate our fingerprints. Compare this to praising God. Each of us is unique to God. No one in all the world can worship God for us. Worship and praise are our gifts to God. No one else can do it for us. Like our fingerprints, our praise is unique to God.

Each one of us is an individual. God made each of us unique. No one can praise God for us. No one can force us to praise God. God wants every one of us to praise Him ourselves.



NATIONAL CAMPORAMA

JULY 13-17, 1998
CAMP EAGLE ROCK
EAGLE ROCK, MISSOURI



LET
FREEDOM
REIGN
ISAIAH 61:1

Have you started raising funds for the 1998 National Camporama? It's coming sooner than you think!

For a free 1998 Camporama information packet, call 1-800-641-4310 and order item 729-202.

CAMPORAMA

building site. After setting up our tents, we lay down for a good night's sleep; the only problem was that the villagers did not. It seems we were the most curious things in the village. Each of us had 10 to 20 Chole Indians looking in our tents as we tried to go to sleep. This was a bit unnerving to say the least. To see all these little faces peering at you while you tried to sleep was like being in a zoo.

In the Andes Mountains we were at about 12,000 feet. The air was so thin that we had to leave our tent flaps open to get enough oxygen. Cooking at that altitude was also a challenge. Water boils at a much lower temperature and it took forever to cook our noodles. The water would boil, but it was not hot enough to cook the pasta. Our coffee was not very hot either.

In our travels we have been transported by airplanes, burros, boats, dugout canoes, buses, trucks, and taxis. Some have been a real experience. I can recall seeing a group of Mexican airport workers in Villahermosa holding up the tail of our airplane (puddle jumper) as we boarded our heaviest men in front to even up the load.

On a truck ride through the Peruvian Andes, a rock slide took out the road. We had to stop and sort-of rebuild the road before we could contin-

ue. We crossed the Andes through a narrow pass at 18,000 feet. At various points, the road was so poor we could look down over the edge and see a couple thousand feet straight down.

Our boat ride down the Amazon was an experience I will never forget. The boat was a double-decker with a capacity of about 150 passengers. When we first got on the boat, there was no one on board, so we hung our hammocks close together and left to attend a church dedication service. (The trip on the river would take all night. That's why we needed hammocks.)

We returned just before the boat left, about 9:00 p.m. When we got on board, we could hardly walk because of all the goods and items going down river to market. On the bow deck we saw some of the largest and strangest fish we had ever seen, including two catfish weighing over 300 pounds each. Once on the upper deck we could not find each other due to the hundreds of hammocks hung all around, both above and below us.

I was awakened about 3:00 a.m. when some fel-

low's chickens got loose and were running across the hammocks. I tried to get out of my hammock, but instead of stepping on the deck, I stepped on a family that had moved in under my hammock! There must have been 500 passengers on that little boat, and that did not include the livestock on the first deck.

There isn't enough room in this magazine to describe in detail all the experiences Pathfinder Missions have endured. It is the most rewarding hard work one will ever do. The best way to find out about Pathfinder Missions is to become a Pathfinder. Contact the Pathfinder Missions coordinator in your district for more information on upcoming trips and get involved in building the kingdom of God.



Headen! for the Rock?



by Rodney Davis



ou don't have a clue about the Rock? Well, the Rock has nothing to do with a prison. You probably won't see anything about it on television or in your local movie theater. It has nothing to do with a British actor named Sean Connery. It is going to be a happenin' place the week of July 13-17, 1998.

When we say that we're headin' for the Rock, we mean Eagle Rock, Missouri, and the 7th National Camporama! Over 5,000 boys and men may be

coming, taking a bus, van, car, or plane, and making their way to Camp Eagle Rock. They will be gathering July 13 to spend about 5 days of pure excitement. This Camporama will be the largest gathering of Royal Rangers and leaders plus guests from foreign countries since the 1994 Camporama. These men and boys are coming to spend one of the most exciting weeks of their summer, ready to have the time of their lives.

If you have never been, or it's been years since you've attended a Camporama, you are in for a thrill at this one. What happens at a Camporama? There will be plenty of awesome things to keep you busy from dawn to dusk. Keep in mind that these are just a few of the radical activities: swimming, canoeing, dirt bikes, archery, races, and a Frontiersman Camping Fellowship village to see. Do you like going to theme parks? If you do, you will be glad to hear that there will be six Pow Wow Theme Parks. Each of these parks will have special activities just for you to enjoy.

On top of this there will be great food to eat! Three times

per day you will gather with 5,000 other Royal Rangers to eat in the dining tent. Can you imagine how big the ovens are to prepare that many meals? Let me tell you, they are on a trailer with an 18-wheeler full of food! The cooks and servers will be busy.

In the evening there will be services with music and an inspiring message. The main feature of each service will be the pageant and a special guest speaker. Each night a new chapter will unfold on stage before your very eyes. The pageants will be filled with suspense, laughter, tears, and outstanding special effects. Many boys will make Jesus their Savior at the Camporama. Did you know that over 1,000 boys accepted Christ as their personal Savior during the last Camporama?

There is no better way to spend a hot summer day than with new friends, great food, and lots of fun. You are already thinking, with all of the activities going on, how will I do it all? I can tell you in two words: you won't! But it will be fun trying!



Ranger Rod's Camporama Planning Tips:

So, you've decided to head for the Rock in July 1998? This may be your first time or it's been a long time since you went to Eagle Rock, and you may be worried that you do not know where to begin. Follow these simple steps and, before you know it, you'll be in the bus on your way to the most exciting week of the summer.

STEP ONE:

Ask your outpost commander to order the Camporama packet by calling 1-800-641-4310 and requesting item 729-202. This packet contains general information, a colorful poster, and a brochure.

Meet the qualifications for application:

A boy must be at least a Pioneer 10 years of age by July 1, 1998, and have been currently involved with the Royal Rangers for the last 6 months.

He must have the following completed forms to attend:

1. Registration form with parent's signature
2. Medical release form
3. Remember the application deadline in April 1, 1998.

STEP TWO:

Begin to raise money. Your outpost commander will want to help you do this by planning candy sales, car washes, walk-a-thons, etc. You will want to

start raising your money for the application fee and transportation costs. The district in which your outpost is located may have a bus chartered so you can travel as a group. It is important to know just how much money you will need so you can allow enough time to raise it before the application deadline. It seems like July will never get here, but now is the time to start raising the money you need.

Should you bring any spending money? You certainly may! Even though all your meals once you arrive at the Camporama are provided as part of your registration, there will be several concession stands, a camp store with souvenirs, and vendors selling many different items. Prices are reasonable. If you don't have very much money, boys on Trader's Row will have items they will be willing to trade with you.

STEP THREE:

Your last point on your Camporama Checklist is: "What do I bring to Eagle Rock?" For some of you it may have been a long, long time since you attended a Camporama. For some of you this will be your very first experience. Here are some ideas of things that might come in handy when you spend a week at Camporama.

—Bring cool clothing. Summer in the Ozarks is hot and humid!
—Bring a swim suit for swimming at the theme parks.
—Sunscreen to prevent sunburn
—Sun glasses

— Small Bible
—Sleeping gear
—Enough changes of clothing to get you to Camp Eagle Rock and home again
—Comfortable shoes. You will do a lot of walking.
—A camera to take pictures for the folks back home
—Poncho in case of rain
—Jeans for when the sun goes down
—Toothbrush, toothpaste, soap, washcloth and towel

*Have your commander contact your district commander for an exact list of clothing items.

Just talking about Camporama has gotten me excited! That week is going to be a totally radical Rangers experience. I hope you'll be headin' for the Rock in July 1998!



RASCAL Rangers



THE ROYAL RANGER CODE

A ROYAL RANGER IS "COURAGEOUS"

HE IS BRAVE IN SPITE OF DANGER, CRITICISM, OR THREATS.

(IN THIS ISSUE, THE ROYAL ORDER OF CHIVALRY WILL HELP US TELL THIS TALE)



BOYS, THIS WILL BE A QUEST LIKE NEVER BEFORE...

BY: DAVID SMITH

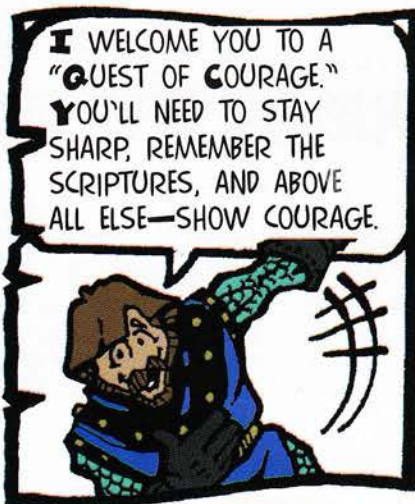

I WELCOME YOU TO A "QUEST OF COURAGE." YOU'LL NEED TO STAY SHARP, REMEMBER THE SCRIPTURES, AND ABOVE ALL ELSE—SHOW COURAGE.



THIS IS GOING TO BE COOL!



IF THERE'S ANY ARCHERY OR SWORD-PLAY, I'LL DO IT!

I CAN HANDLE ANY RIDDLES OR SCRIPTURES WE NEED TO PASS.

...LATER IN THE DARK... WOODS...

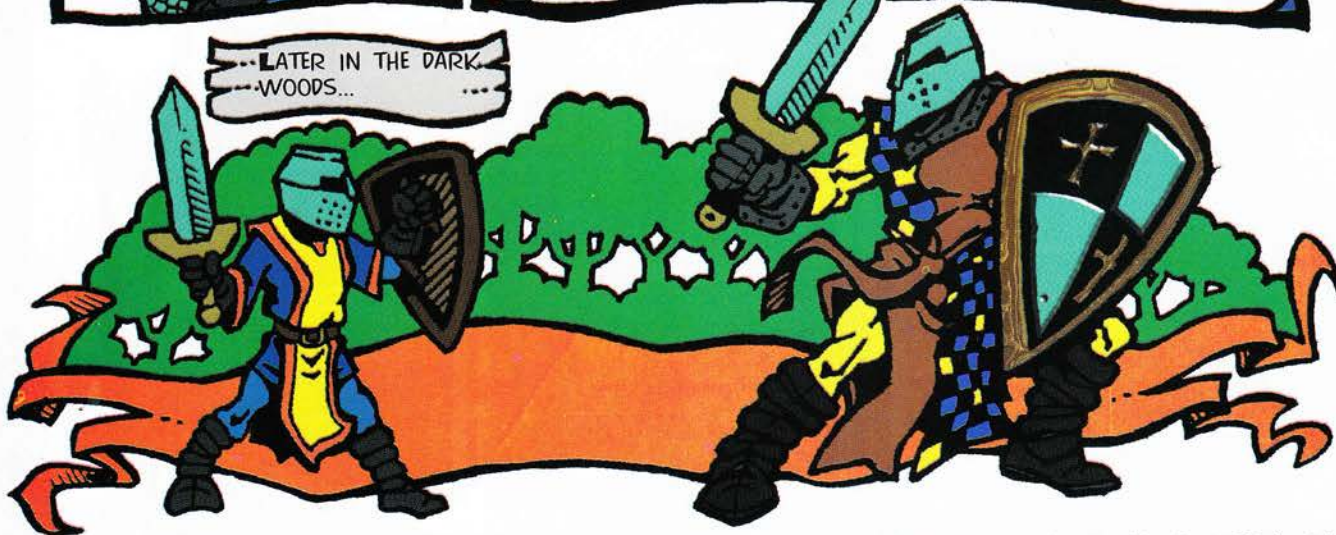

THE BOYS FOUND OUT IN ORDER TO PASS THE TEST THEY HAD TO FIGHT A HUGE, MEAN KNIGHT!



I'M GOING TO SQUASH YOU LIKE BUGS!

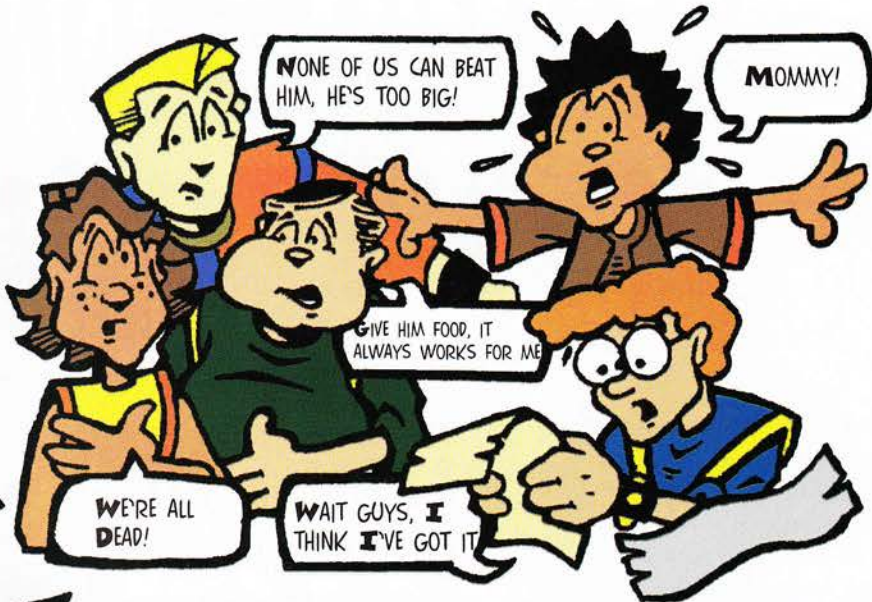

NONE OF US CAN BEAT HIM, HE'S TOO BIG!

MOMMY!

GIVE HIM FOOD, IT ALWAYS WORKS FOR ME

WE'RE ALL DEAD!

WAIT GUYS, I THINK I'VE GOT IT



FIGHT ME!

STOP!

WE WILL SPARE YOU THE HORROR OF WHAT HAPPENED NEXT IN THE FATE OF THOSE FIVE NOBLE BOYS AND THE HUGE, MEAN KNIGHT.



LATER...

WELL BOYS, IT APPEARED YOU PASSED WITH FLYING COLORS!! NOW TELL ME, HOW DID YOU HANDLE THAT HUGE, MEAN KNIGHT?

IT WAS EASY. WE USED OUR COURAGE.



WE REALIZED THERE IS ONE THING THAT TAKES THE MOST COURAGE, SO WE STOOD OUR GROUND AND TOLD HIM ABOUT JESUS AND HIS LOVE. WE PRAYED TOGETHER, AND HE LET US PASS.

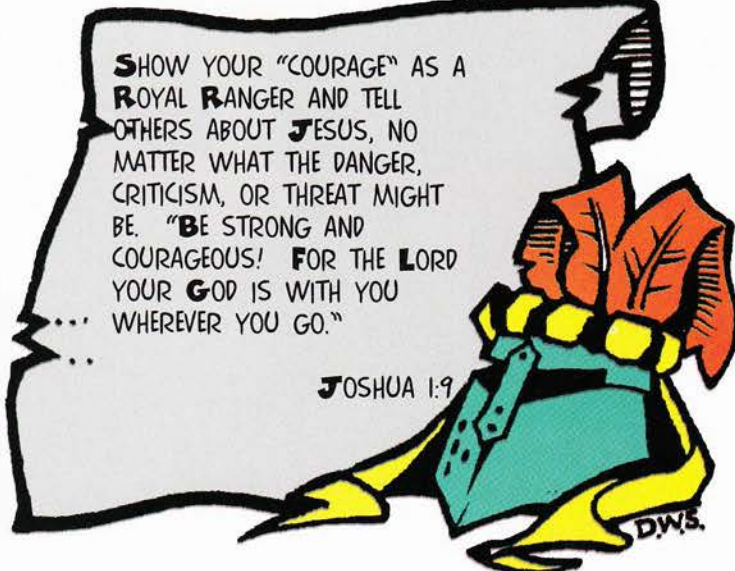

SHOW YOUR "COURAGE" AS A ROYAL RANGER AND TELL OTHERS ABOUT JESUS, NO MATTER WHAT THE DANGER, CRITICISM, OR THREAT MIGHT BE. "BE STRONG AND COURAGEOUS! FOR THE LORD YOUR GOD IS WITH YOU WHEREVER YOU GO."

JOSHUA 1:9

DWS.

COMEDY CORNER

An airliner flew into a violent thunderstorm and was soon swaying and bumping around the sky. One very nervous lady happened to be sitting next to a pastor and turned to him for comfort.

"Can't you do something?" She pleaded fearfully.

"I'm sorry ma'am," said the minister gently. "I'm in sales, not management."

by Thomas LaMance

A Straight Arrows commander started his class period with a short quiz. The first question he asked was, "Does anyone know where you can find the Beatitudes?"

There was a silence as 6-year-olds pondered. Finally one boy raised his hand.

"I don't know for sure," he said. "but maybe they are in the Yellow Pages."

by Thomas LaMance

NIV CROSSWORD #1

ANGELS #1

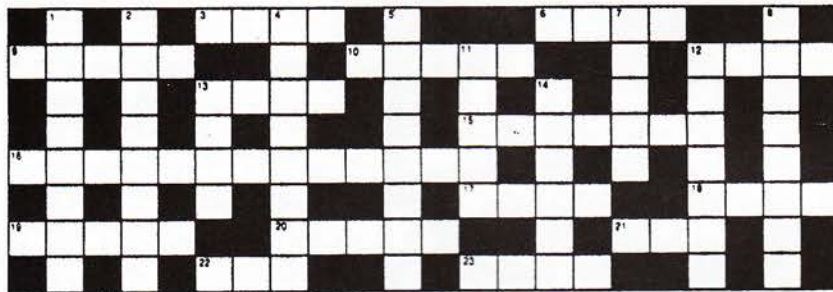

ACROSS

3. An angel in charge of the waters said the Lord was _____. (Rev. 16:5)
6. Where an angel stood in front of Balaam. (Num. 22:24)
9. An angel at Bokim said the gods would be _____. (Judg. 2:3)
10. This fell off Peter when the angel struck him. (Acts 12:7)
12. This fell when the third angel sounded his trumpet. (Rev. 8:10)
13. An angel delivered Jacob from _____. (Gen. 48:16)
15. Hebrew name of an angel of the Abyss. (Rev. 9:11)
16. An angel told Manoah his name was beyond _____. (Judg. 13:18)
17. Cherubim were placed on what side of Eden? (Gen. 3:24)
18. Who told John to write to the angel at Laodicea? (Rev. 3:14)
19. It was reported to the angel standing among the myrtle trees that the world was in _____. (Zech. 1:11)
20. Where the angel hurled the censer filled with fire. (Rev. 8:5)
21. Zechariah asked the angel about the two branches beside the golden pipes that had golden _____. (Zech. 4:12)
22. An angel ordered whom to tell David to build an altar? (1 Chron. 21:18)

20. John saw an angel that was in charge of _____. (Rev. 14:18)

DOWN

1. An angel told Zechariah the olive branches represented two who were _____. (Zech. 4:14)
2. The angel of his _____ saved the house of Israel. (Isa. 63:9)
4. An angel told Jacob to look up and see these goats. (Gen. 31:11-12)
5. Zechariah asked the angel about four _____. (Zech. 6:1, 4)
7. An angel said that no workman of any _____ would ever be found in Babylon. (Rev. 18:22)
8. The beast's kingdom was plunged into _____ when the fifth angel poured out his bowl. (Rev. 16:10)
11. The third angel said that anyone who worships the beast and his _____, will drink the wine of God's fury. (Rev. 14:9)
12. An angel told Peter to put on _____. (Acts 12:8)
13. Appearing with the angel, in the presence of the shepherds, was a _____. (Luke 2:13)
14. An angel told Paul he must appear before _____. (Acts 27:23-24)

(Please see the next issue of the *High Adventure* for answers to the crossword)

The preacher said, "Brothers, my sermon this morning will be about liars. Now, has everyone read the 35th chapter of Matthew?"

Half the hands in the congregation went up.

"You're just the people I want to talk to," said the preacher. "There is no such chapter."

by Thomas LaMance

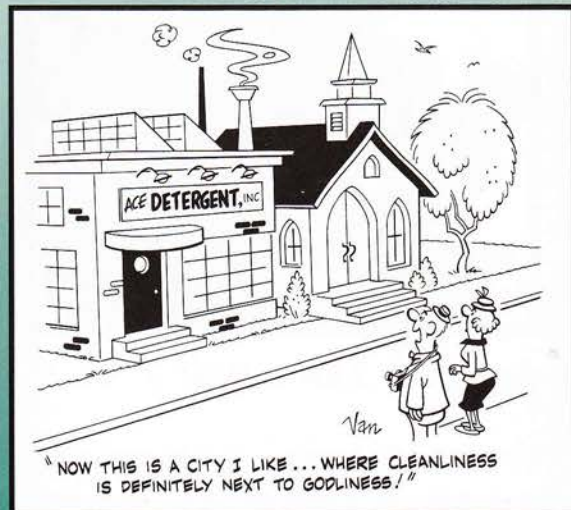

HEY MOM AND DAD!

It's Camporama time, and there's a few things you should know. The 1998 Camporama may be next year, but now is the time to start thinking on how to get your boy prepared!

Check out this issue for informative Camporama articles, as well as upcoming issues. Ask the church outpost commander for specific details and information. Start thinking on how to raise the funds so your boy not only can afford to go, but also make it an experience finance free.

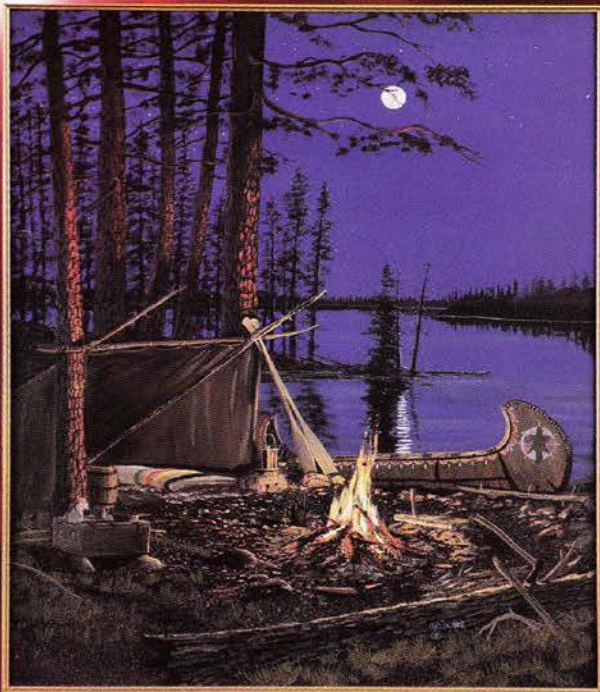

The cover of this issue is an original painting by Fred Deaver. This is a one-of-a-kind, no prints will be made. Throughout the magazine several black and white prints of Fred Deaver's works are also featured.

PINEWOOD

DERBY



FREE

Royal Rangers Catalog 75AW2028
and Pinewood Derby Brochure
75AW2323.

CHECK OUT OUR FULL LINE OF
PINEWOOD DERBY PRODUCTS!

On Your Mark...

Build your dream racer with these quality products—

Pinewood Car Kit Includes soft wood car body, black wheels, axles, and screws.	18AW7540	\$1.95
Steering Wheel	17AW7399	20¢
Headlights (2)	17AW7400	20¢
Acrylic Paint Kit 6 mini-pots.	18AW7541	\$1.45
Graphite Lube Micro-fine, .21 oz.	18AW7542	\$1.45
Lead Weight 3.5 oz.	18AW7543	\$1.45
Lapel Pin Clutch pin back. 7/8" x 1 1/8"	15AW0117	\$1.65

Pinewood Derby Decals Add the finishing touch.

Royal Rangers Emblem (1")	14AW6831	49¢
Flames	14AW6826	\$2.45
Sponsor #1	14AW6827	\$2.45
Sponsor #2	14AW6828	\$2.45
Personalized Plates	14AW6829	\$1.55
Number Sheet #24	14AW6830	\$2.45

Get Set...

Pinewood Derby T-Shirts

Full-color racing design with "Pinewood Derby—The ultimate racing experience!" White. 50% cotton/50% polyester.

Boys S (6-8)	08AW5743	\$6.50
Boys M (10-12)	08AW5745	\$6.50
Boys L (14-16)	08AW5746	\$6.50
Adult S	08AW5747	\$7.50
Adult M	08AW5748	\$7.50
Adult L	08AW5749	\$7.50
Adult XL	08AW5750	\$7.50
Adult XXL	08AW5751	\$8.50
Adult XXXL	08AW5752	\$9.50

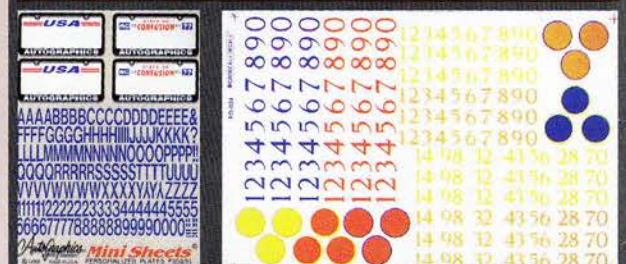

GO!!!

Don't delay. Order today.

1-800-641-4310

(\$5 minimum)

Fax Toll Free 1-800-328-0294
International Fax 1-417-862-5881



GOSPEL PUBLISHING HOUSE
1445 Boonville Avenue
Springfield, MO 65802-1894

Postage and handling charges: Less than \$10.00, 15%; \$10.00-\$49.99, 10%; \$50.00 or more, 8%. State sales tax: CA, 7.25%. Foreign orders will be billed actual shipping. Prices are subject to change without notice. All orders subject to credit approval. MasterCard, VISA, and Discover accepted. Please provide card number, signature, and expiration date.